



ORTHODONTIC
PRODUCT CATALOG

VOL. 11





Online Account Management

Our state-of-the-art website is now fully integrated with our accounting system. Your account will be accurate showing real time updates. Ordering orthodontic products and account management has never been easier. Our system is secure and available 24/7 for your convenience. Visit www.dynaflex.com.



Top Notch Customer Service

DynaFlex® has a talented team of people who care. Our Territory Managers and Customer Care Specialists work with clinician's and staff everyday to build a business partnership and a solid long lasting relationship that we pride ourselves on. Our Team is available to help by phone, 866-346-5665, or online chat, www.dynaflex.com/order!



Worldwide Distribution

We are proud to say that our products are now recognized and used by doctors all over the world due to our high quality standards and excellence in manufacturing.



Advanced Technology

Leading the way is a statement we take to heart. From that we continue to utilize the newest technology and advanced manufacturing techniques delivering the highest level of quality and service in the industry.



Welcome to the DynaFlex® Orthodontic Products Catalog.

We hope you enjoy this edition of our catalog and we look forward to supplying your practice with all your orthodontic product needs.

Important Information

Ordering Information: Online ordering is secure and available 24/7. Enroll in our online system to link to your DynaFlex account. Once enrolled, ordering and reordering are easier than ever. Visit www.dynaflex.com/enroll to get started. If you need assistance or would like to place your order over the phone, our Customer Care Team is available by phone or online chat from 7:30am-5:00pm CST Monday through Friday. If you would like to place an order after hours, our voice mail system is able to receive your order or if you prefer please leave a message and our Customer Care Team will return your call the following business day.

Shipments: Orders placed prior to 2pm CST are shipped the same day. All product orders are shipped UPS Ground Service. However, we offer 2nd Day, 3rd Day and Next Day Air Service upon request for an additional fee. International orders are shipped by customer's requested service or by most economical service when not specified.

Product Returns: In accordance with FDA and ISO Regulations, all product returns must include a Return Merchandise Authorization number (RMA) which can be obtained by contacting our Customer Service Department. Products may be returned for credit within 30 days from invoice date. Returns must meet quality inspection standards, appearance and physical count. After 31 days and up to 60 days from the invoice date, a request for return will be evaluated by a Customer Service Representative as a courtesy to our customer. For returns during the 31-60 day period products that are accepted for return may be subject to a 20% restocking fee. Custom imprint orders, hot stamped orders and pre-welded band assemblies are not accepted for return/credit. No return or credit will be issued for products over 60 days from invoice date.

DynaFlex® makes every effort to keep pricing consistent, however prices in this catalog, on our website and in sales flyers are subject to change. By purchasing products or services from DynaFlex, you agree to our terms and conditions. To view these, visit www.dynaflex.com.

Physical Address: **8050 Hawk Ridge Trail | Lake St. Louis, MO 63367**

P.O. Box Address: **P.O. Box 390 Wentzville, MO 63385**

















Toll Free: **866-346-5665** | Local: **314-426-4020** | Fax: **314-426-1967** | International: **001-314-426-4020**

www.dynaflex.com | info@dynaflex.com

Products Proudly Manufactured In The USA



TABLE OF CONTENTS

The Norris System	pg. 4-9, 24-25, 74-75	
Glacier®	pg. 10, 159, 190	
SmileShare™	pg. 11	
MEDIT	pg. 12-13	
Precision Aligner Buttons®	pg. 14-15	
CS® System	pg. 16-17	
Brackets	pg. 19-51	
Bands & Attachments	pg. 53-59	
Buccal Tubes	pg. 61-69	
Archwire & Auxiliaries	pg. 71-101	
Elastomerics, Facemasks, Organizers	pg. 103-111	
Bonding Supplies, Retractors, & Mirrors	pg. 113-137	
Instruments	pg. 139-155	
Interproximal Stripping	pg. 157-161	
Miscellaneous	pg. 163-177	
Laboratory Supplies	pg. 179-201	



*Actual Patient Photos

THE Norris SYSTEM

The Norris 20/26® System is a new dimension in treatment efficiency and by far the most advanced progression in passive self-ligation and arch form technology to date.

Conceived by Dr. Robert "Tito" Norris, it is the culmination of his years of experience in treating with leading passive self-ligating systems, along with his background in mechanical engineering. Together, he was able to identify both the physical attributes and clinical shortcomings of competitive appliances and determine which design elements would most benefit today's practicing orthodontist.

The result is a true twin, passive/active self-ligating appliance system with a reduced slot dimension of .020" x .026", combined with a series of extra broad arch form wires.

- Control Without Compromise
- Improved Workflow
- Clinical Efficiency
- Facial Aesthetics

Request Full Informational Brochure at www.dynaflex.com/norris2026



Dr. Tito Norris

Orthodontist and Creator of The Norris System

In conjunction with DynaFlex®, Dr. Robert "Tito" Norris has developed the Norris 20/26® Bracket System. His unique background in mechanical engineering provides him with a distinct advantage in mastering the forces, vectors, and movements inherent in performing orthodontic treatment.

To Learn More

www.dynaflex.com/norris2026

FEATURES *and* BENEFITS

Nickel-Free Cobalt-Chromium Alloy:

Cobalt chromium not only boasts superior frictional characteristics but is also completely nickel-free.

Integrated Hooks:

Strong integrated hooks accommodate all directions of elastic wear.

Universal Bicuspid Hooks:

Reduces inventory with multiple interchangeable brackets. One bracket serves all upper premolars.

Deep Tie Wing Undercuts:

Optimal tie wing depth for elastic chain, ties or steel ligatures.

.020" x .026" Slot:

Reduced slot dimension delivers unparalleled control. Clinically shown to be 26% more efficient than the leading PSL bracket system.

Rounded Leading Edge Of Door:

Leading edge of door which aids in arch wire seating.



**More About
Norris Brackets
On Page 24-25**



Scan The QR Code To View
The Norris System Products

Center Scribe Line:

Center scribe line aligns the long axis for accurate placement.

Unparalleled Bond Strength:

Engineered to conform to each tooth and create unmatched bond strength.

Straight Occlusal Edge:

The occlusal edge of the new gingivally offset premolar bracket base is straight so that it can more easily be used as a paralleling guide to the marginal ridges of a premolar.

Mesial Distal Span Of Door:

Width of reciprocal door provides additional rotational control.

Self-Ligating Molar Tube

Full 6-6 Self-Ligating System

Flawless. Self-Gliding
DOOR MECHANISM

Unfailing door with reciprocal mechanism and audible opening and closing "click", proven to last throughout treatment. Opening the bracket door has never been easier. Insert the Norris Exclusive "Triple Tool" horizontally into the door slot and rotate 90 degrees. The unique mechanism inside the door of the bracket allows the door to actually "glide open" and "glide closed" once the door travels 50% in either direction. This "assisted" opening and closing is the first and only one of its kind, and is another leap forward in PSL technology.

Norris **EXTRA BROAD** ARCHWIRE



Rounded Rectangular
*Shape Makes The Process
Smoother Than Ever!*

ROUNDED RECTANGULAR

Control Without Compromise

Makes insertion, clip closure, and seating smoother than ever. The sharp corners are rounded so torque control is not compromised.

As with the Norris 20/26® Brackets, the Norris Extra Broad wires are a break from convention and take what we know about expanded arches and aesthetic expression to a whole new level. Once again, Dr. Robert "Tito" Norris learned from observation and trial and error, then synthesized what he experienced from the use of existing broad arch forms into the extra broad arch form we have now developed. A non-coordinated arch makes it possible to treat both the maxilla and mandible with the same form. Thirty percent broader than the broadest arch on the market, this extra broad arch achieves a number of key efficiencies and effects: it affords maximum space as it expresses each tooth to its full outer- most potential; it gains maximum leveling and alignment as the teeth are afforded a greater range of motion; it influences the musculature of the surrounding soft tissue earlier in preparation for subsequent desired reprogramming; and it introduces a collaborative dynamic sooner between the bracket and the wire.

Throughout the later working and finishing stages of treatment, a "Rounded" Rectangular (19x25) arch wire is introduced (yet another DynaFlex® exclusive) that makes insertion, clip closure, and seating smoother than ever. Norris Extra Broad Wires are the perfect complement in how they fully express the torque and tip of the bracket over existing passive systems, yet without the binding of other higher frictional systems. Most importantly, however, is how they both fit to produce broader, more expressive smiles than anything else available today.

The Norris Extra Broad Archwires are 30% broader than the broadest arch on the market. This extra broad arch achieves a number of key efficiencies and effects:

- **Maximum Leveling & Alignment**
Teeth are afforded a greater range of motion.
- **Treating Posterior Cross Bite**
The broad shaped archwire can often be effective at correcting crossbites.
- **Produces A Beautiful Broad Smile**
Reduces The Dark Posterior Buccal Corridors and expresses each tooth to its full outer- most potential.
- **Pre-Stopped**
This helps control wire shifting archwire and can be tightened at any position along the arch in accordance with the doctor's preference.
- **19x25 "Rounded Rectangular"**
This "Rounded-Rectangular" NiTi, Beta and Stainless Steel archwire shape makes insertion, clip closure, and seating smoother than ever. Only the sharp corners are rounded so torque control is not compromised.

**More About
Norris Archwire
On Page 74-75**

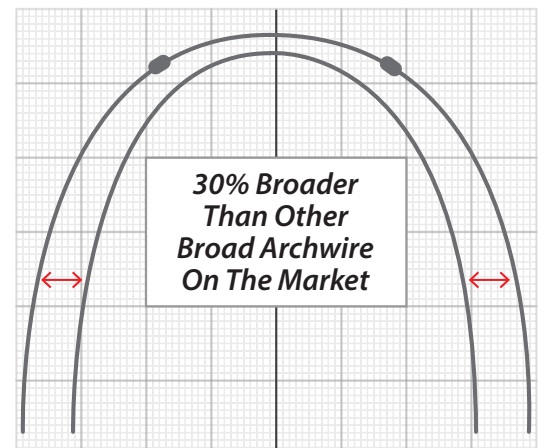

THE *Norris* SYSTEM

PATIENT CASE

- Initial: Class III with a antereolateral open bite, reverse smile arc, maxillary crowding and mandibular spacing.
- Appointment 1: Brackets were indirectly bonded at initial appointment. Norris Extra Broad, .014" NiTi.
- Appointment 3: Norris Extra Broad, .019 x .025" NiTi. Strong tongue pushed the mandibular anterior teeth into an anterior cross-bite. Mandibular lingual bite turbos & elastic chains were placed to assist in re-capturing positive overjet.
- Appointment 8: Total Treatment Time = 12 months



INITIAL RECORDS



APPOINTMENT 1



APPOINTMENT 3



APPOINTMENT 8



Want a great way to get started?

We offer carefully crafted kits with minimal inventory required. This makes the Norris System simple and easy for you and your staff to get started.

THE Norris Intro Kit



Intro Kits come with a "Risk Free Guarantee". If you are unhappy for any reason, we will accept returns of unopened product within 90 days of purchase, hassle-free.

Also, we offer 4 great options if you are interested in our Pro Kits.

All Norris System kits and individual components come with simple and straight forward pricing. Talk to your Local Territory Sales Manager for details and specific pricing information.



Scan the QR code to learn more about The Norris System kits.

5-5 INTRO KIT

10 Sets w/ Free Tools and Wire

W/ Offset Premolars: #216-01C5-INT | W/ Standard Premolars: #217-01C5-INT

SKU	QTY	ITEM	COST
#216-01C5	10	5-5 BRACKET SETS	Price You Pay
#09-216-200	2	.014 EXTRA BROAD NiTi	Included
#09-226-550	2	.018 x .018 EXTRA BROAD NiTi	Included
#09-426-700	2	.019 x .025 ROUNDED RECT. EXTRA BROAD NiTi	Included
#09-326-700	2	.019 x .025 EXTRA BROAD ROUNDED RECT. BETA	Included
#216-5005	1	TRIPLE TOOL - DOOR OPENER	Included
#216-5000	1	HIP TOOL - ARCHWIRE SEATER	Included

6-6 INTRO KIT

10 Sets w/ Free Tools and Wire

W/ Offset Premolars: #216-01C6-INT | W/ Standard Premolars: #217-01C6-INT

SKU	QTY	ITEM	COST
#216-01C6	10	6-6 BRACKET SETS	Price You Pay
#09-216-200	2	.014 EXTRA BROAD NiTi	Included
#09-226-550	2	.018 x .018 EXTRA BROAD NiTi	Included
#09-426-700	2	.019 x .025 ROUNDED RECT. EXTRA BROAD NiTi	Included
#09-326-700	2	.019 x .025 EXTRA BROAD ROUNDED RECT. BETA	Included
#216-5005	1	TRIPLE TOOL - DOOR OPENER	Included
#216-5000	1	HIP TOOL - ARCHWIRE SEATER	Included

5-5 PRO SET KIT

60 Sets w/ Free Sets, Tools & Typodont

W/ Offset Premolars: #216-01C5-PRO | W/ Standard Premolars: #217-01C5-PRO

SKU	QTY	ITEM	COST
#216-01C5	66	(60) 5-5 BRACKET SETS, (6) FREE 5-5 BRACKET SETS	Price You Pay
#216-5005	3	TRIPLE TOOL - DOOR OPENER	Included
#216-5000	3	HIP TOOL - ARCHWIRE SEATER	Included
#3824-NORRIS	1	NORRIS SYSTEM TYPODONT (5-5)	Included

6-6 PRO SET KIT

60 Sets w/ Free Sets, Tools & Typodont

W/ Offset Premolars: #216-01C6-PRO | W/ Standard Premolars: #217-01C6-PRO

SKU	QTY	ITEM	COST
#216-01C6	66	(60) 6-6 BRACKET SETS, (6) FREE 6-6 BRACKET SETS	Price You Pay
#216-5005	3	TRIPLE TOOL - DOOR OPENER	Included
#216-5000	3	HIP TOOL - ARCHWIRE SEATER	Included
#3824-NORRIS2	1	NORRIS SYSTEM TYPODONT (6-6)	Included

5-5 PRO WIRE KIT

60 Sets w/ Free Archwires, Tools & Typodont

W/ Offset Premolars: #216-01C5-PRO+ | W/ Standard Premolars: #217-01C5-PRO+

SKU	QTY	ITEM	COST
#216-01C5	60	5-5 BRACKET SETS	Price You Pay
#09-216-200	5	.014 EXTRA BROAD NiTi	Included
#09-226-550	5	.018 X .018 EXTRA BROAD NiTi	Included
#09-426-700	5	.019 x .025 EXTRA BROAD ROUNDED RECT. NiTi	Included
#09-326-700	5	.019 x .025 EXTRA BROAD ROUNDED RECT. BETA	Included
#216-5005	5	TRIPLE TOOL - DOOR OPENER	Included
#216-5000	5	HIP TOOL - ARCHWIRE SEATER	Included
#3824-NORRIS	1	NORRIS SYSTEM TYPODONT (5-5)	Included

6-6 PRO WIRE KIT

60 Sets w/ Free Archwires, Tools & Typodont

W/ Offset Premolars: #216-01C6-PRO+ | W/ Standard Premolars: #217-01C6-PRO+

SKU	QTY	ITEM	COST
#216-01C6	60	6-6 BRACKET SETS	Price You Pay
#09-216-200	5	.014 EXTRA BROAD NiTi	Included
#09-226-550	5	.018 X .018 EXTRA BROAD NiTi	Included
#09-426-700	5	.019 x .025 EXTRA BROAD ROUNDED RECT. NiTi	Included
#09-326-700	5	.019 x .025 EXTRA BROAD ROUNDED RECT. BETA	Included
#216-5005	5	TRIPLE TOOL - DOOR OPENER	Included
#216-5000	5	HIP TOOL - ARCHWIRE SEATER	Included
#3824-NORRIS2	1	NORRIS SYSTEM TYPODONT (6-6)	Included

★★★
**BEST
SELLER**

GLACIER®

Ultra Premium Thermoform Material

Glacier® is an Ultra Premium Thermoform Material that we built for durability, clarity and comfort during treatment. It provides excellent ductility that adapts to undercuts and gingival embrasures, while being flexible enough to allow comfortable insertion and removal. Glacier® offers a high range of activation and memory while applying biocompatible forces with superior aesthetic quality for precise tooth movements. Glacier® is a DynaFlex® proprietary material, manufactured to our specifications and high quality standards.

For Fabrication of Aligners and Retainers

- Durable
- Superior Clarity
- Grab-Force Technology
- Enhanced Tooth Movement
- Box of 100
- Made In The USA



SIZE	SHAPE	ITEM NUMBER
.030 x 125mm	Round	#0764-030
.035 x 125mm	Round	#0764-035
.040 x 125mm	Round	#0764-040
.030mm	Square (5"x 5")	#0765-030
.035mm	Square (5"x 5")	#0765-035
.040mm	Square (5"x 5")	#0765-040



**Bulk Purchases Of Glacier® Material Are Available.
Call Our Customer Care Team For Details!**

Scan The QR Code
To Learn More

SmileShare™

Clear Aligners

**CONTROL.
VERSATILITY.
SIMPLIFIED.**

Our Clear Aligners are now SmileShare Clear Aligners. This newly updated digital treatment software and case management platform allows you to have full control of your patient's treatment plan using a variety of impressive tools to evaluate and make direct adjustments. Best of all, this powerful piece of software is unbelievably easy to use and extremely comprehensive.

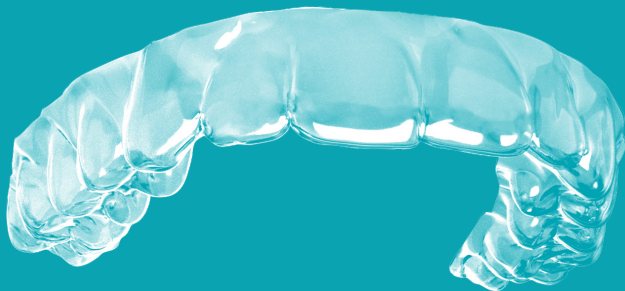

Scan The QR Code
To Learn More

Visit www.dynaflex.com/smileshare-about to learn more

MEDIT *i700*

Unleash Your Clinic's Potential



Scan The QR Code
To Learn More

The Medit i700 is the key to unleash your clinic's full potential, with a powerful hardware and intelligent software.

The Medit i700 makes the scanning experience a comfortable one for both dentist and patient.

#07-MEDI700

Medit i700 Features



245g
Featherweight



UV-C LED
Disinfection

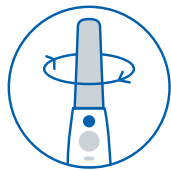

180°
Reversible Tips

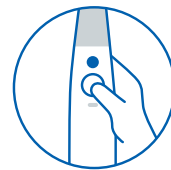

Remote Control
Button

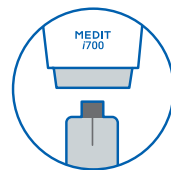

Detachable
Cable

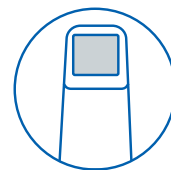

Wide Scan
Area



Contact your local territory manager
to schedule a **FREE** demo

Medit i700 Kit Includes

Calibration Tool
#07-1000



Tip Set (4)
#07-1002



Desktop Cradle
#07-1004



Wall Mount Holder
#07-1006



Power Hub
#07-1008



Handpiece Cover
#07-1010



Wrist Strap
#07-1012



Power Delivery Cable
#07-1014



USB 3.0 Cable
#07-1016



Medical Adapter & Power Cord
#07-1018



Practice Model
#07-1020



*One set of all accessories are included with the purchase of a handpiece

Medit i700 Specifications

Scanning technology	Scanning Frame	Up to 70 FPS
	Imaging Technology	3D-in-motion video technology / 3D full color streaming capture
	Light Source	LED
	Anti-goffing technology	Adaptive anti-fogging
Accuracy	Full-arch	10.9µm ± 0.98
Handpiece	Dimensions	248 x 44 x 47.4 mm
	Weight	245g
Tip	Tip Size	22.2 x 15.9 mm
	Mirror angle	45-degree angle
	Scan area	15 x 13 mm
	Autoclavable	Up to 100 times
	Reversible tip	Autoclave 121°C 30 mins / Autoclave 134°C 4 mins
Special Mode	Remote control mode	Yes
	UV-C disinfection	Yes
Cable	Length	2.0m / Handpiece Detachable
	Connectivity	USB 3.1 Gen1 (C Power Delivery)

Recommended High Performance System Requirements

	Laptop	Desktop
CPU	Intel Core i9 - 10980HK AMD Ryzen 9 4900H / 5900H	Intel Core i9 - 10900HK AMD Ryzen 9 5900X
RAM	32 GB	
Graphic Card	Nvidia GeForce RTX 2070 / 2080 / 3080 / 3090 Above 8GB (Not supporting Radeon)	
OS	Window 10 Pro 64-bit	

Recommended Baseline System Requirements

	Laptop	Desktop
CPU	Intel Core i7 - 10750HK AMD Ryzen 7 4800H / 5800H	Intel Core i7 - 10700HK AMD Ryzen 7 5800X
RAM	32 GB	
Graphic Card	Nvidia GeForce RTX 1660 / 2060 / 3060 Above 6GB (Not supporting Radeon)	
OS	Window 10 Pro 64-bit	

PRECISION Aligner Buttons®

The Only Bondable Buttons Designed Specifically For Clear Aligners.



Scan The QR Code
To Learn More

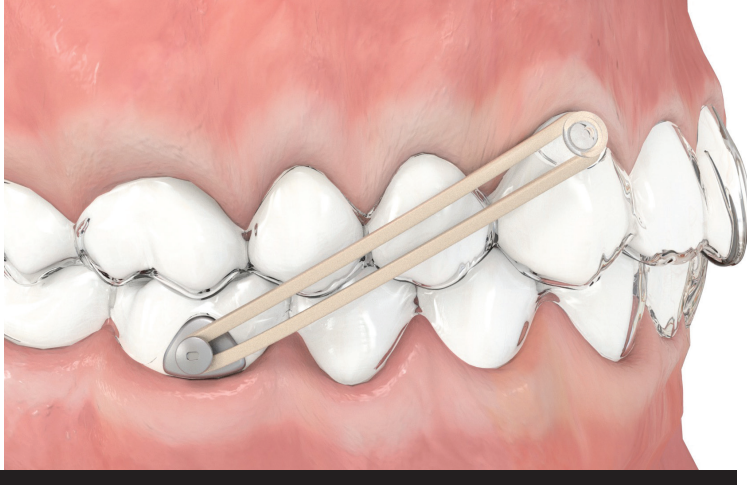

Clear

Precisely fits the cutout windows of upper and lower canines and premolars.



Metal

Created to fit the cutout windows of upper and lower molars.

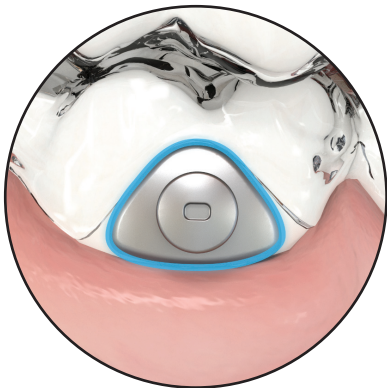

Precise Fit

The shape of the base pad is perfectly tailored to fit the aligner cutout windows.

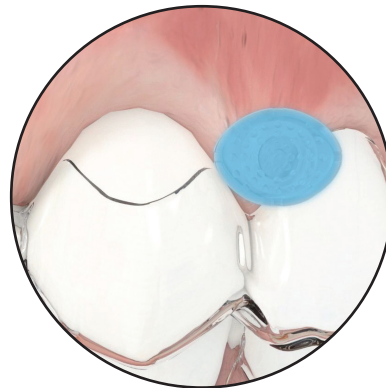

Reliable Bond Strength

The maximized surface area of the base pad prevents detachment.

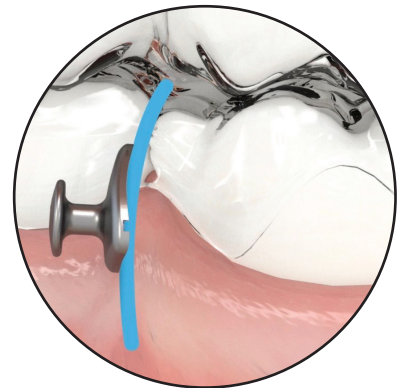

Developed for Gumline Placement

Instead of the center of the crown, our anatomically-contoured base pad matches the shape of the tooth at the gingival third

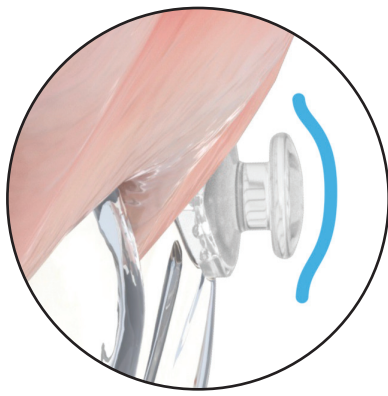

Engineered Button Head

Our enhanced button head makes it easy to attach elastics of different sizes, improving patient compliance and comfort.

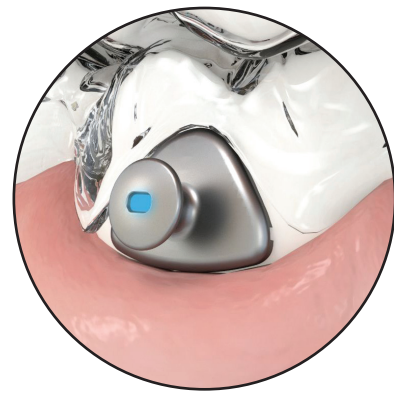

Perfect Placement

The dimple on the button face is intended for precise positioning using an explorer or scaler.



Precision Aligner Button® - Metal

The only bondable button designed for Aligner Therapy. Engineered to fit perfectly within the aligner cut-outs. Contoured to match the shape of the tooth at the gumline. Beveled edges allows base to slide slightly under tray and prevent gum irritation. For best results, program the cut-out in center of tooth. 25 Pack.

#10-PAB10204



Precision Aligner Button® - Clear

The only bondable button designed for Aligner Therapy. Engineered to fit perfectly within the aligner cut-outs. Contoured to match the shape of the tooth at the gumline. Beveled edges allows base to slide slightly under tray and prevent gum irritation. For best results, program the cut-out in center of tooth. 10 Pack.

#10-PABCLR

“Precision Aligner Buttons® are the only buttons we use when incorporating elastics with clear aligners. They give me the control and efficacy that I enjoy with elastic button cutouts, but without the emergency appointments.”



Dr. Neal Kravitz
South Riding, VA

“Precision Buttons® give me the peace of mind of a perfect fit every time on every patient lending to greater comfort and fewer failures. I never imagined they could make such a positive difference and impact but they have!”



Dr. Jonathan Nicozisis
Princeton, NJ



THE ULTIMATE CLASS II & CLASS III CORRECTOR

Simple, Effective, Proven

The all new DynaFlex® exclusive CS®5 System delivers non-compliance treatment for your toughest Class II & Class III cases. The Twist-Lock Pivot was skillfully designed as a one-piece component with no moving parts. This will guarantee a no-hassle installation and improved performance. The widely known CS® spring is made from an exclusive nickel titanium material with specially built key-hole ends that improve the strength and durability by 40%. This spring will load force instantly and remain extremely consistent throughout treatment with the confidence of longer usage. The benefit is a smoother, more constant force that performs better and lasts longer.

The CS® System creates instant and consistent force levels, providing a smoother, more constant force that performs better and lasts longer. This system is one of the most successful Class II and Class III chairside appliances used in the world due to its simplicity, effectiveness and value pricing as compared to other systems available today. Join the thousands of doctors worldwide that use the CS® System. This is a must have system for your orthodontic tool box.

The Hybrid Screws are coated with blue Nylok™ coating around the threading of the screw. This medical grade material is blue for easy identification and guarantees a more secure fit. Coating the screw threading offers resistance to loosening within the pivot and seals the threading of the screw into place.



CS®5 SPRING

Instant Loading
Constant Force

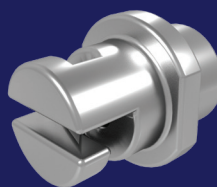

TWIST-LOCK PIVOT

Simplified Installation
One-Piece Design
Improved Performance



MAGNETIC ALLEN PENCIL

Safer Placement
Quick Installation



HYBRID SCREW WITH NYLOK™

Resistance To Loosening
More Secure Fit

RESULTS MATTER

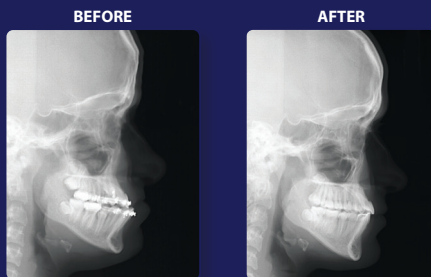

Class III X-Rays: Case photos compliments of Dr. Andy Hayes of St. Louis, MO

INSTANT LOADING AND MORE CONSISTENT FORCE LEVELS

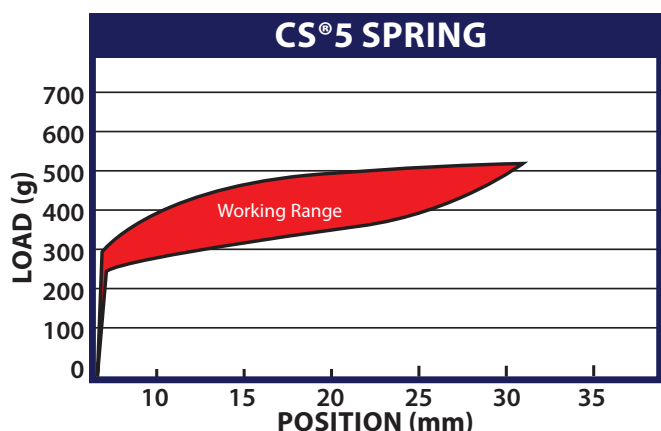
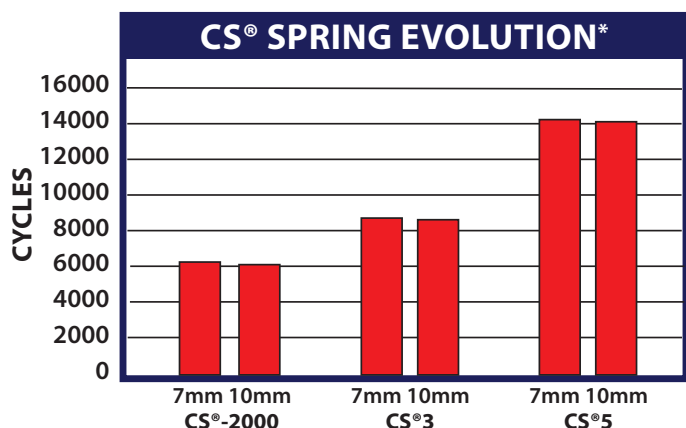

**Test results were recorded during extremely abusive conditions.

“DynaFlex® CS® is my appliance of choice for Class III correction. It’s easy to place and compatible with all bracket systems. It’s also easy on the patient. You get excellent, proven results in a short period of time. I am always amazed at how much Class III correction you can achieve in just a couple of visits.”

Dr. Katherine Friedman
Litchfield County Orthodontics



Scan QR Code For Twist-Lock Instructions



5 PATIENT KIT		
TRADITIONAL PIVOT	.018 PIVOT	.022 PIVOT
10mm Spring	#39-1810-5M	#39-2210-5M
7mm Spring	#39-1807-5M	#39-2207-5M
TWIST-LOCK PIVOT		
10mm Spring	#39-T10-5M	
7mm Spring	#39-T07-5M	
MASTER KIT	.018 PIVOT	.022 PIVOT
Complete	#39T-018M	#39T-022M
COMPONENTS	ITEM #	
CS®5 Niti Spring 10mm	#38094	
CS®5 Niti Spring 7mm	#38114	
Traditional Pivot .022 x .025	#3810-E	
Traditional Pivot .018 x .025	#3830-E	
SL Pivot	#3810-SL	
SL Tool	#3823-SL	
Twist-Lock Pivot	#3810-T	
Hybrid Screw With Nylok™	#3815-5MC	
Allen Pencil	#3823-EM	
Magnet	#3823-500	

WHAT'S INCLUDED:

5 Patient:

- 10 CS®5 NiTi Springs
- 20 Pivots (Twist-Lock or Traditional)
- 20 Hybrid Screws With Nylok™
- 1 Allen Pencil
- 1 Magnet

Master Kit:

- 20 10mm CS®5 Springs
- 20 7mm CS®5 Springs
- 20 Twist-Lock Pivots
- 20 Traditional Pivots
- 40 Hybrid Screws With Nylok™
- 1 Allen Pencil
- 1 Magnet

BRACKETS



Metal Bracket Lines

DynaFlex® is your total solution for high quality precision direct bonding brackets. Using state of the art materials during the manufacturing process provides controlled tolerance of the slot, low profile materials, and tie wings that are rounded for smooth patient comfort. DynaFlex® uses the best materials and the highest quality systems available, you know the products you are using will exceed your expectations.



Norris 20/26® Brackets are the flagship Self-ligating System by DynaFlex®.

The bracket provides more control with a unique .020 x .026 slot dimension, while incorporating the best-in class features such as four true tie-wings with undercuts that can accommodate ligature ties and elastic chain; Cobalt- Chromium composition for nickel-free use by allergy-sensitive patients; a flawless door mechanism with "glided" opening and closing; universal bicuspid hooks for reduced inventory; and a mechanical base for trouble-free bonding.

See pages 24-25.



See pages 30-31

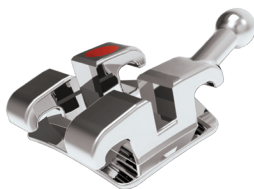

The **Atlas Mini** is our most popular twin metal bracket system. Depending on the system of choice, the Atlas bracket line provides specific torque, angulation and rotation; with precise tooth movement and outstanding treatment results.

See pages 26-29.



See pages 32-33



The **Atlas Standard** has the same great features as our Atlas Mini Bracket but 30% larger. Wider tie wing positioning allows for excellent rotational control and the larger base enhances bond strength.

See pages 34-35.

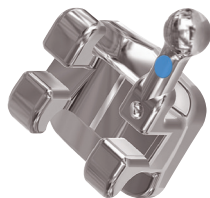

MTX™ Brackets create the perfect smile with unlimited features such as one-piece MIM construction, rounded slot entry, perfectly contoured for great fit, and ultra-smooth slot. Previously known as Artista (Ortho-Direct) & Futura (MAO).

See pages 36-37.

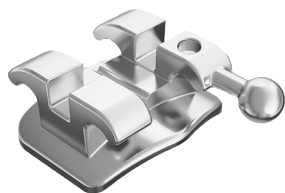

Gemini™ Stainless Steel Bracket offer ultimate full rotational control with their state-of-the-art base design that incorporates torque. Every bracket's compound-contoured base is anatomically designed for an accurate fit. Simplified bracket placement and improved bond strength help make your job easier.

See pages 38-39.

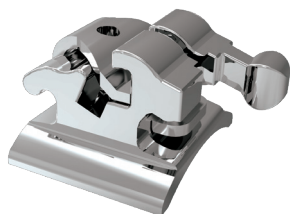

Endurance® Self-Ligating Bracket is a fully interactive self-ligating bracket with a Nickel Titanium spring clip. Clip allows for an exceptional memory characteristic, delivering continuous and consistent forces without deformation.

See pages 40-41.

Aesthetic Bracket Lines

With any of our bracket systems you have the ability to choose a wide range of treatment options that best suits the needs of your practice and treatment protocols. Whether your preference is a stainless steel or aesthetically pleasing brackets, DynaFlex® offers a wide selection for your product needs.



ClearViz+™ Mini is a highly aesthetic bracket made of revolutionary Monocrystalline Sapphire material. With superior strength and durability, the possibilities are endless for those patients looking for cosmetic options.

See pages 42-43.



ClearViz+™ is the same as our ClearViz+™ Mini with a slightly larger mesial distal direction. A clear bracket your patients will love. Previously known as ClearTek (Ortho-Direct).

See pages 44-45.



ClearTek™ Mini Brackets are the ultimate aesthetic bracket. Brackets are crystal clear monocrystalline sapphire, stain resistant, have high bond strength, easy debonding and have a low bracket profile.

See pages 46-47.



The Krystal™ SL is precisely manufactured using a combination of copolymers and ceramics to create a translucent, glass-like appearance for superior cosmetics. This innovative bracket has a super smooth surface that will not stain, break or flex during treatment. Superior aesthetics in a completely clear self-ligating bracket makes this the ideal choice for superior treatment!

See pages 48-49.



Krystal™ Brackets are the choice for a true ceramic bracket! Manufactured from 99.9% pure alumina oxide, these polycrystalline brackets are non-staining and do not discolor. Krystal Brackets are a true twin design offering outstanding bond, high strength, precise tip and torque and are very easy to ligate. Your patients will be pleased with the comfort and aesthetic look! Previously known as Natralyke (Ortho-Direct) and Spectra (MAO).

See pages 50-51.

MAXILLARY

Complete Bracket Reference Chart

Bracket Lines	CENTRAL		LATERAL		CUSPID			1ST BICUSPID			2ND BICUSPID		
	TRQ	ANG	TRQ	ANG	TRQ	ANG	ROT	TRQ	ANG	ROT	TRQ	ANG	ROT
Norris 20/26®	+12	+5	+8	+9	0	+5	0	-5	0	0	-5	0	0
Atlas Mini - Roth*	+12	+5	+8	+9	-2	+11	0	-7	0	0	-7	0	0
Atlas Mini - MBT*	+17	+4	+10	+8	-7	+8	0	-7	0	0	-7	0	0
Atlas Standard Edgewise	0	0	0	0	0	0	0	0	0	0	0	0	0
Atlas Vertical Slot - Roth*	+12	+5	+8	+9	-2	+11	0	-7	0	0	-7	0	0
Atlas Light & Bright Gold- Roth	+12	+5	+8	+9	-2	+11	0	-7	0	0	-7	0	0
Atlas Light & Bright Gold - MBT	+17	+4	+10	+8	-7	+8	0	-7	0	0	-7	0	0
Atlas Standard - Roth*	+12	+5	+8	+9	-2	+11	0	-7	0	0	-7	0	0
Atlas Standard - MBT*	+17	+4	+10	+8	-7	+8	0	-7	0	0	-7	0	0
MTX™ - Roth*	+12	+5	+8	+9	-2	+13	+4	-7	0	0	-7	0	0
MTX™ - MBT*	+17	+4	+10	+8	-7	+8	0	-7	0	0	-7	0	0
Gemini™ - Roth*	+12	+5	+8	+9	0	+11	0	+7	0	0	-7	0	0
Gemini™ - MBT*	+17	+4	+8	+8	-7	+8	0	-7	0	0	-7	0	0
Endurance® SL - Roth*	+12	+5	+8	+9	-2	+11	0	-7	0	0	-7	0	0
Endurance® SL - MBT*	+17	+4	+10	+8	-7	+8	0	-7	0	0	-7	0	0
Kystal™ SL - Roth*	+12	+5	+8	+9	-2	+8	0	-7	0	0	-7	0	0
Krystal™ SL - MBT*	+17	+5	+10	+8	0	+8	0	-7	0	0	0	0	0
Krystal™ - Roth*	+12	+5	+8	+9	0	+11	0	-7	0	0	-7	0	0
Krystal™ - MBT*	+17	+4	+10	+8	0	+8	0	-7	0	0	-7	0	0
ClearViz+™ Mini - Roth*	+12	+5	+8	+9	-2	+11	0	-7	0	0	-7	0	0
ClearViz+™ Mini MBT*	+17	+4	+10	+8	-7	+8	0	-7	0	0	-7	0	0
ClearViz+™ Roth*	+12	+5	+8	+9	-2	+11	0	-7	0	0	-7	0	0
ClearViz+™ MBT*	+17	+4	+10	+8	-7	+8	0	-7	0	0	-7	0	0
ClearTek™ - Roth*	+12	+5	+8	+9	0	+11	0	-7	0	0	-7	0	0
ClearTek™ - MBT*	+17	+4	+10	+8	-7	+8	0	-7	0	0	-7	0	0

MANDIBULAR

Complete Bracket Reference Chart

Bracket Lines	LOWER ANTERIORS		CUSPID			1ST BICUSPID			2ND BICUSPID		
	TRQ	ANG	TRQ	ANG	ROT	TRQ	ANG	ROT	TRQ	ANG	ROT
Norris 20/26®	-5	0	0	+5	0	-12	0	0	-12	0	0
Atlas Mini - Roth*	0	0	-11	+5	0	-17	0	0	-22	0	0
Atlas Mini - MBT*	-6	0	-6	+3	0	-12	+2	0	-17	+2	0
Atlas Standard Edgewise	0	0	0	0	0	0	0	0	0	0	0
Atlas Vertical Slot - Roth*	0	0	-11	+5	0	-17	0	0	-22	0	0
Atlas Light & Bright Gold - Roth	0	0	-11	+5	0	-17	0	0	-22	0	0
Atlas Light & Bright Gold - MBT	-6	0	-6	+3	0	-12	+2	0	-17	+2	0
Atlas Standard - Roth*	-1	+2	-11	+5	0	-17	0	0	-22	0	0
Atlas Standard - MBT*	-6	0	-6	+3	0	-12	+2	0	-17	+2	0
MTX™ - Roth*	-6	0	-11	+7	+2	-17	0	0	-22	0	0
MTX™ - MBT*	0	0	-6	+3	0	-12	+2	0	-17	+2	0
Gemini™ - Roth*	0	0	-11	+5	0	-17	0	0	-22	0	0
Gemini™ - MBT*	-6	0	-6	+3	0	-12	0	0	-17	0	0
Endurance® SL - Roth*	0	0	-11	+7	0	-17	0	0	-22	0	0
Endurance® SL - MBT*	-6	0	6	+3	0	-12	+2	0	-17	+2	0
Krystal™ SL - Roth*	0	0	-11	+5	2	-17	0	0	-22	0	0
Krystal™ SL - MBT*	-6	0	0	+3	2	-12	+2	0	-17	+2	0
Krystal™ - Roth*	0	0	-11	+5	0	-17	0	0	-22	0	0
Krystal™ - MBT*	-6	0	0	3	0	-12	+2	0	-17	+2	0
ClearViz+™ Mini Roth*	-1	0	-11	+7	0	-17	0	0	-22	0	0
ClearViz+™ Mini MBT*	-6	0	0	+3	0	-12	+2	0	-17	+2	0
ClearViz+™ Roth*	0	0	-11	+5	0	-17	0	0	-22	0	0
ClearViz+™ MBT*	-6	0	-6	+3	0	-12	+2	0	-17	+2	0
ClearTek™ - Roth*	0	0	-11	+5	0	-17	0	0	-22	0	0
ClearTek™ - MBT*	-6	0	-6	+3	0	-12	+2	0	-17	+2	0

Norris 20/26[®]

BRACKET SYSTEM

FEATURES *and* BENEFITS

Nickel-Free Cobalt-Chromium Alloy:

Cobalt-chromium not only boasts superior frictional characteristics but is also completely nickel-free.

Integrated Hooks:

Strong integrated hooks accommodate all directions of elastic wear.

Universal Bicuspid Hooks:

Reduces inventory with multiple interchangeable brackets. One bracket serves all upper premolars.

Deep Tie Wing Undercuts:

Optimal tie wing depth for elastic chain, ties or steel ligatures.

.020" x .026" Slot:

Reduced slot dimension delivers unparalleled control. Clinically shown to be 26% more efficient than the leading PSL bracket system.

Rounded Leading Edge Of Door:

Leading edge of door which aids in arch wire seating.



Scan The
QR Code To View
The Norris System
Products



Center Scribe Line:

Center scribe line aligns the long axis for accurate placement.

Unparalleled Bond Strength:

Engineered to conform to each tooth and create unmatched bond strength.

Straight Occlusal Edge:

The occlusal edge of the new gingivally offset premolar bracket base is straight so that it can more easily be used as a paralleling guide to the marginal ridges of a premolar.

Mesial Distal Span Of Door:

Width of reciprocal door provides additional rotational control.

Self-Ligating Molar Tube

Full 6-6 Self-Ligating System

Flawless, Self-Gliding DOOR MECHANISM

Unfailing door with reciprocal mechanism and audible opening and closing “click”, proven to last throughout treatment. Opening the bracket door has never been easier. Insert the Norris Exclusive “Triple Tool” horizontally into the door slot and rotate 90 degrees. The unique mechanism inside the door of the bracket allows the door to actually “glide open” and “glide closed” once the door travels 50% in either direction. This “assisted” opening and closing is the first and only one of its kind, and is another leap forward in PSL technology.

Rounded
Leading
Edge

Audible
Click
When
Opened
or Closed

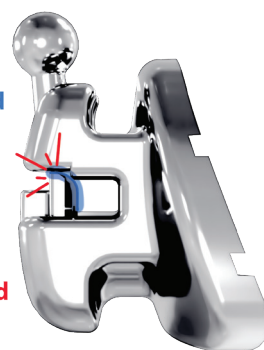

brackets

Bracket Prescription Reference Chart

		Univ HKS	Univ HKS	Distal HKS					Distal HKS	Univ HKS	Univ HKS				
UPPER	UR7	UR6	UR5	UR4	UR3	UR2	UR1		UL1	UL2	UL3	UL4	UL5	UL6	UL7
Torque	-20	-15	-5	-5	0	8	12		12	8	0	-5	-5	-15	-20
Tip	0	0	0	0	5	9	5		5	9	5	0	0	0	0
Rotation	0	10	0	0	0	0	0		0	0	0	0	0	10	0
In/out	-	-	0.69	0.69	0.69	0.89	0.89		0.89	0.89	0.69	0.69	0.69	-	-
LOWER	LR7	LR6	LR5	LR4	LR3	LR2	LR1		LL1	LL2	LL3	LL4	LL5	LL6	LL7
Torque	-20	-20	-12	-12	0	-5	-5		-5	-5	0	-12	-12	-20	-20
Tip	0	0	0	0	5	0	0		0	0	5	0	0	0	0
Rotation	0	0	0	0	0	0	0		0	0	0	0	0	0	0
In/out	-	0.69	0.69	0.69	0.69	1.0	1.0		1.0	1.0	0.69	0.69	0.69	-	-

ITEM #	BRACKET SETS
#216-01C5	Norris 20/26° Brackets Full Set, U / L 5 - 5, W/ Offset Premolars
#216-01C6	Norris 20/26° Brackets Full Set, U / L 6 - 6, W/ Offset Premolars
#217-01C5	Norris 20/26° Brackets Full Set, U / L 5 - 5, W/ Standard Premolars
#217-01C6	Norris 20/26° Brackets Full Set, U / L 6 - 6, W/ Standard Premolars
ITEM #	BRACKET 10 PACKS
#216-1011	Norris 20/26° Brackets, Maxillary Right, Central
#216-1012	Norris 20/26° Brackets, Maxillary Right, Lateral
#216-1013	Norris 20/26° Brackets, Maxillary Right, Cuspid W/ Hk
#216-1014	Norris 20/26° Brackets, Maxillary Universal, Bicuspid W/ Hk, W/ Offset Premolars
#216-1014N	Norris 20/26° Brackets, Maxillary Universal, Bicuspid W/ Hk, W/ Standard Premolars
#216-2021	Norris 20/26° Brackets, Maxillary Left, Central
#216-2022	Norris 20/26° Brackets, Maxillary Left, Lateral
#216-2023	Norris 20/26° Brackets, Maxillary Left, Cuspid W/ Hk
#216-3031	Norris 20/26° Brackets, Mandibular, Lower Anteriors
#216-3033	Norris 20/26° Brackets, Mandibular Right, Cuspid W/ Hk
#216-3034	Norris 20/26° Brackets, Mandibular Universal, Bicuspid W/ Hk, W/ Offset Premolars
#216-3034N	Norris 20/26° Brackets, Mandibular Universal, Bicuspid W/ Hk, W/ Standard Premolars
#216-4043	Norris 20/26° Brackets, Mandibular Left, Cuspid W/ Hk

Atlas Mini Bracket System

A truly exceptional bracket that is perfect in all aspects. Simply put, the Atlas Mini is a bracket you and your staff can rely on. The superior strength and tremendous durability of the Atlas Mini is due to the combined manufacturing of extremely strong stainless steel and the precise brazing technique to add an 80 gauge foil mesh pad. The impressive features of Atlas include: 17-4 stainless steel, 80 gauge foil mesh pad, silky smooth slot and low profile design gives you the confidence to accomplish treatment in the most difficult malocclusions only dreamed of with other brackets. This is the bracket that will make you, your staff and your patients smile brighter!

Available in .018 and .022. Roth, Roth with Offset Base, MBT, MBT with Offset Base and Edgewise Rx.



Atlas Mini Bracket System – Roth Rx

MAXILLARY	REF	HK	TRQ	ANG	M/D	IN/OUT	.018 RIGHT	.018 LEFT	.022 RIGHT	.022 LEFT		
Central	UR ● UL ●	-	+12	+5	3.4	0.61mm	#201-R8-11	#201-R8-21	#201-R2-11	#201-R2-21		
Lateral	UR ● UL ●	-	+8	+9	2.8	0.80mm	#201-R8-12	#201-R8-22	#201-R2-12	#201-R2-22		
Cuspid	UR ● UL ●	-	-2	+11	3.0	0.58mm	#201-R8-13	#201-R8-23	#201-R2-13	#201-R2-23		
Cuspid w/ Hook	UR ● UL ●	D	-2	+11	3.0	0.58mm	#201-R8-131	#201-R8-231	#201-R2-131	#201-R2-231		
1st Bicuspid	UR ● UL ●	-	-7	0	2.8	0.59mm	#201-R8-14	#201-R8-24	#201-R2-14	#201-R2-24		
1st Bicuspid w/ Hook	UR ● UL ●	M	-7	0	2.8	0.59mm	#201-R8-141	#201-R8-241	#201-R2-141	#201-R2-241		
1st Bicuspid w/ DG Hk	UR ● UL ●	D	-7	0	2.8	0.59mm	#201-R8-141D	#201-R8-241D	#201-R2-141D	#201-R2-241D		
2nd Bicuspid	UR ● UL ●	-	-7	0	2.8	0.59mm	#201-R8-15	#201-R8-25	#201-R2-15	#201-R2-25		
2nd Bicuspid w/ Hook	UR ● UL ●	M	-7	0	2.8	0.59mm	#201-R8-151	#201-R8-251	#201-R2-151	#201-R2-251		
2nd Bicuspid w/ DG Hk	UR ● UL ●	D	-7	0	2.8	0.59mm	#201-R8-151D	#201-R8-251D	#201-R2-151D	#201-R2-251D		
MANDIBULAR	REF	HK	TRQ	ANG	M/D	IN/OUT	.018 RIGHT	.018 LEFT	.022 RIGHT	.022 LEFT		
Lower Anteriors	LR ● LL ●	-	0	0	2.3	0.78mm	#201-R8-31	Universal	#201-R2-31	Universal		
Cuspid	LR ● LL ●	-	-11	+5	2.8	0.61mm	#201-R8-33	#201-R8-43	#201-R2-33	#201-R2-43		
Cuspid w/ Hook	LR ● LL ●	D	-11	+5	2.8	0.61mm	#201-R8-331	#201-R8-431	#201-R2-331	#201-R2-431		
1st Bicuspid	LR ● LL ●	-	-17	0	2.8	0.64mm	#201-R8-34	#201-R8-44	#201-R2-34	#201-R2-44		
1st Bicuspid w/ Hook	LR ● LL ●	M	-17	0	2.8	0.64mm	#201-R8-341	#201-R8-441	#201-R2-341	#201-R2-441		
1st Bicuspid w/ DG Hk	LR ● LL ●	D	-17	0	2.8	0.64mm	#201-R8-341D	#201-R8-441D	#201-R2-341D	#201-R2-441D		
2nd Bicuspid	LR ● LL ●	-	-22	0	2.8	0.69mm	#201-R8-35	#201-R8-45	#201-R2-35	#201-R2-45		
2nd Bicuspid w/ Hk	LR ● LL ●	M	-22	0	2.8	0.69mm	#201-R8-351	#201-R8-451	#201-R2-351	#201-R2-451		
2nd Bicuspid w/ DG Hk	LR ● LL ●	D	-22	0	2.8	0.69mm	#201-R8-351D	#201-R8-451D	#201-R2-351D	#201-R2-451D		
FULL SETS							.018 SLOT					.022 SLOT
Upper/Lower 5x5 No Hks							#201-R8-NHK					#201-R2-NHK
Upper/Lower 5x5 Hks on 3's							#201-R8-3					#201-R2-3
Upper/Lower 5x5 Hks on 3,4,5's							#201-R8-345					#201-R2-345
Upper/Lower 5x5 Hks on 3,4,5's Distal Gingival Bicuspid							#201-R8-345DG					#201-R2-345DG

Strength & Durability



Scan The QR Code To Learn More

Color Enhanced ID For Easy Identification

17-4 Stainless Steel

Generous Tie Wing Space For Easy Ligation

Ultra Low Profile For Enhanced Patient Comfort

Smooth Slot Edges For Superior Sliding And Less Friction

Torque In Base

Permanent Laser Etched Marking



80-Gauge Mesh Pad

Palmer Notation On The Pad For Easy Identification











































Superior Bond Strength



Atlas Mini Bracket System with Offset Base - Roth Rx

MAXILLARY	REF	HK	TRQ	ANG	M/D	IN/OUT	.018 RIGHT	.018 LEFT	.022 RIGHT	.022 LEFT
1st Bicuspid	UR ● UL ●	-	-7	0	2.8	0.59mm	#201-R8-140-2	#201-R8-240-2	#201-R2-140-2	#201-R2-240-2
1st Bicuspid w/ Hk	UR ● UL ●	D	-7	0	2.8	0.59mm	#201-R8-1410-2	#201-R8-2410-2	#201-R2-1410-2	#201-R2-2410-2
2nd Bicuspid	UR ● UL ●	-	-7	0	2.8	0.59mm	#201-R8-150-2	#201-R8-250-2	#201-R2-150-2	#201-R2-250-2
2nd Bicuspid w/ Hk	UR ● UL ●	D	-7	0	2.8	0.59mm	#201-R8-1510-2	#201-R8-2510-2	#201-R2-1510-2	#201-R2-2510-2
MANDIBULAR	REF	HK	TRQ	ANG	M/D	IN/OUT	.018 RIGHT	.018 LEFT	.022 RIGHT	.022 LEFT
1st Bicuspid	LR ● LL ●	-	-17	0	2.8	0.64mm	#201-R8-340-2	#201-R8-440-2	#201-R2-340-2	#201-R2-440-2
1st Bicuspid w/ Hk	LR ● LL ●	D	-17	0	2.8	0.64mm	#201-R8-3410-2	#201-R8-4410-2	#201-R2-3410-2	#201-R2-4410-2
2nd Bicuspid	LR ● LL ●	-	-22	0	2.8	0.69mm	#201-R8-350-2	#201-R8-450-2	#201-R2-350-2	#201-R2-450-2
2nd Bicuspid w/ Hk	LR ● LL ●	D	-22	0	2.8	0.69mm	#201-R8-3510-2	#201-R8-4510-2	#201-R2-3510-2	#201-R2-4510-2

Atlas Mini Bracket System – MBT™ Rx

MAXILLARY	REF	HK	TRQ	ANG	M/D	IN/OUT	.018 RIGHT	.018 LEFT	.022 RIGHT	.022 LEFT		
Central	UR  UL 	-	+17	+4	3.1	0.4mm	#201-M8-11	#201-M8-21	#201-M2-11	#201-M2-21		
Lateral	UR  UL 	-	+10	+8	2.8	0.78mm	#201-M8-12	#201-M8-22	#201-M2-12	#201-M2-22		
Cuspid	UR  UL 	-	-7	+8	2.8	0.4mm	#201-M8-13	#201-M8-23	#201-M2-13	#201-M2-23		
Cuspid	UR  UL 	-	0	+8	2.8	0.4mm	#201-M8-13C	#201-M8-23C	#201-M2-13C	#201-M2-23C		
Cuspid w/ Hk	UR  UL 	D	-7	+8	2.8	0.4mm	#201-M8-131	#201-M8-231	#201-M2-131	#201-M2-231		
Cuspid w/ Hk	UR  UL 	D	0	+8	2.8	0.4mm	#201-M8-131C	#201-M8-231C	#201-M2-131C	#201-M2-231C		
1st Bicuspid	UR  UL 	-	-7	0	2.8	0.4mm	#201-M8-14	#201-M8-24	#201-M2-14	#201-M2-24		
1st Bicuspid w/ Hk	UR  UL 	M	-7	0	2.8	0.4mm	#201-M8-141	#201-M8-241	#201-M2-141	#201-M2-241		
1st Bicuspid DG Hk	UR  UL 	D	-7	0	2.8	0.4mm	#201-M8-141D	#201-M8-241D	#201-M2-141D	#201-M2-241D		
2nd Bicuspid	UR  UL 	-	-7	0	2.8	0.4mm	#201-M8-15	#201-M8-25	#201-M2-15	#201-M2-25		
2nd Bicuspid w/ Hk	UR  UL 	M	-7	0	2.8	0.4mm	#201-M8-151	#201-M8-251	#201-M2-151	#201-M2-251		
2nd Bicuspid DG Hk	UR  UL 	D	-7	0	2.8	0.4mm	#201-M8-151D	#201-M8-251D	#201-M2-151D	#201-M2-251D		
MANDIBULAR	REF	HK	TRQ	ANG	M/D	IN/OUT	.018 RIGHT	.018 LEFT	.022 RIGHT	.022 LEFT		
Lower Anteriors	LR  LL 	-	-6	0	2.2	0.76mm	#201-M8-31	Universal	#201-M2-31	Universal		
Cuspid	LR  LL 	-	-6	+3	2.8	0.4mm	#201-M8-33	#201-M8-43	#201-M2-33	#201-M2-43		
Cuspid w/ Hook	LR  LL 	D	-6	+3	2.8	0.4mm	#201-M8-331	#201-M8-431	#201-M2-331	#201-M2-431		
1st Bicuspid	LR  LL 	-	-12	+2	2.8	0.4mm	#201-M8-34	#201-M8-44	#201-M2-34	#201-M2-44		
1st Bicuspid w/ Hk	LR  LL 	M	-12	+2	2.8	0.4mm	#201-M8-341	#201-M8-441	#201-M2-341	#201-M2-441		
1st Bicuspid DG Hk	LR  LL 	D	-12	+2	2.8	0.4mm	#201-M8-341D	#201-M8-441D	#201-M2-341D	#201-M2-441D		
2nd Bicuspid	LR  LL 	-	-17	+2	2.8	0.4mm	#201-M8-35	#201-M8-45	#201-M2-35	#201-M2-45		
2nd Bicuspid w/ Hk	LR  LL 	M	-17	+2	2.8	0.4mm	#201-M8-351	#201-M8-451	#201-M2-351	#201-M2-451		
2nd Bicuspid DG Hk	LR  LL 	D	-17	+2	2.8	0.4mm	#201-M8-351D	#201-M8-451D	#201-M2-351D	#201-M2-451D		
FULL SETS							.018 SLOT					.022 SLOT
Upper/Lower 5x5 No Hks							#201-M8-NHK					#201-M2-NHK
Upper/Lower 5x5 Hks on 3's							#201-M8-3					#201-M2-3
Upper/Lower 5x5 Hks on 3,4,5's							#201-M8-345					#201-M2-345
Upper/Lower 5x5 Hks on 3,4,5's Distal Gingival Bicuspid							#201-M8-345DG					#201-M2-345DG

*DynaFlex® does not imply any endorsements from Drs. McLaughlin, Bennett and Trevisi and does not claim to be an exact duplicate of the MBT™ system. MBT™ is a registered trademark of 3M/Unitek Corporation. © Copyright 2021

Atlas Mini Bracket System with Offset Base - MBT™ Rx

MAXILLARY	REF	HK	TRQ	ANG	M/D	IN/OUT	.018 RIGHT	.018 LEFT	.022 RIGHT	.022 LEFT
1st Bicuspid	UR ● UL ●	-	-7	0	2.8	0.4mm	#201-M8-140-2	#201-M8-240-2	#201-M2-140-2	#201-M2-240-2
1st Bicuspid w/ Hook	UR ● UL ●	D	-7	0	2.8	0.4mm	#201-M8-1410-2	#201-M8-2410-2	#201-M2-1410-2	#201-M2-2410-2
2nd Bicuspid	UR ● UL ●	-	-7	0	2.8	0.4mm	#201-M8-150-2	#201-M8-250-2	#201-M2-150-2	#201-M2-250-2
2nd Bicuspid w/ Hook	UR ● UL ●	D	-7	0	2.8	0.4mm	#201-M8-1510-2	#201-M8-2510-2	#201-M2-1510-2	#201-M2-2510-2
MANDIBULAR	REF	HK	TRQ	ANG	M/D	IN/OUT	.018 RIGHT	.018 LEFT	.022 RIGHT	.022 LEFT
1st Bicuspid	LR ● LL ●	-	-12	+2	2.8	0.4mm	#201-M8-340-2	#201-M8-440-2	#201-M2-340-2	#201-M2-440-2
1st Bicuspid w/ Hook	LR ● LL ●	D	-12	+2	2.8	0.4mm	#201-M8-3410-2	#201-M8-4410-2	#201-M2-3410-2	#201-M2-4410-2
2nd Bicuspid	LR ● LL ●	-	-17	+2	2.8	0.4mm	#201-M8-350-2	#201-M8-450-2	#201-M2-350-2	#201-M2-450-2
2nd Bicuspid w/ Hook	LR ● LL ●	D	-17	+2	2.8	0.4mm	#201-M8-3510-2	#201-M8-4510-2	#201-M2-3510-2	#201-M2-4510-2

Atlas Mini Bracket System – Edgewise Rx

MAXILLARY	REF	HK	TRQ	ANG	M/D	.018 RIGHT	.018 LEFT	.022 RIGHT	.022 LEFT	
Central	UR ● UL ●	-	0	0	3.3	#201-S8-11	#201-S8-21	#201-S2-11	#201-S2-21	
Lateral	UR ● UL ●	-	0	0	3.0	#201-S8-12	#201-S8-22	#201-S2-12	#201-S2-22	
Cuspid	UR ● UL ●	-	0	0	3.3	#201-S8-13	#201-S8-23	#201-S2-13	#201-S2-23	
Cuspid w/ Hook	UR ● UL ●	D	0	0	3.3	#201-S8-131	#201-S8-231	#201-S2-131	#201-S2-231	
1st Bicuspid	UR ● UL ●	-	0	0	3.0	#201-S8-14	#201-S8-24	#201-S2-14	#201-S2-24	
1st Bicuspid w/ Hook	UR ● UL ●	M	0	0	3.0	#201-S8-141	#201-S8-241	#201-S2-141	#201-S2-241	
2nd Bicuspid	UR ● UL ●	-	0	0	3.0	#201-S8-15	#201-S8-25	#201-S2-15	#201-S2-25	
2nd Bicuspid w/ Hook	UR ● UL ●	M	0	0	3.0	#201-S8-151	#201-S8-251	#201-S2-151	#201-S2-251	
MANDIBULAR	REF	HK	TRQ	ANG	M/D	.018 RIGHT	.018 LEFT	.022 RIGHT	.022 LEFT	
Lower Anteriors	LR ● LL ●	-	0	0	2.5	#201-S8-31	Universal	#201-S2-31	Universal	
Cuspid	LR ● LL ●	-	0	0	3.3	#201-S8-33	#201-S8-43	#201-S2-33	#201-S2-43	
Cuspid w/ Hook	LR ● LL ●	D	0	0	3.3	#201-S8-331	#201-S8-431	#201-S2-331	#201-S2-431	
1st Bicuspid	LR ● LL ●	-	0	0	3.0	#201-S8-34	#201-S8-44	#201-S2-34	#201-S2-44	
1st Bicuspid w/ Hook	LR ● LL ●	M	0	0	3.0	#201-S8-341	#201-S8-441	#201-S2-341	#201-S2-441	
2nd Bicuspid	LR ● LL ●	-	0	0	3.0	#201-S8-35	#201-S8-45	#201-S2-35	#201-S2-45	
2nd Bicuspid w/ Hook	LR ● LL ●	M	0	0	3.0	#201-S8-351	#201-S8-451	#201-S2-351	#201-S2-451	
FULL SETS			.018 SLOT				.022 SLOT			
Upper/Lower 5x5 Hooks on 3,4,5's			#201-S8-345				#201-S2-345			

Atlas Mini *Light Gold* Bracket System

Our Atlas Mini Light Gold brackets are refreshingly beautiful as well as extremely functional. With all the same great features of our Atlas Mini bracket along with the aesthetic appeal of Light Gold, your options have no limits with DynaFlex® bracket systems. The Light Gold bracket retains all the strength and durability of the Atlas Mini as well as the ultra-smooth slot that improves sliding mechanics and enhances patient treatment time. Our exclusive coating process leaves a brilliant, smooth finish without the risk of abrasion or peeling off.

Available in .018 and .022 – Roth or MBT.



Atlas Mini Light Gold Bracket System - Roth

MAXILLARY	HK	TRQ	ANG	M/D	IN/OUT	.018 RIGHT	.018 LEFT	.022 RIGHT	.022 LEFT	
Central	-	+12	+5	3.4	0.61mm	#200-1811	#200-1821	#204-2211	#204-2221	
Lateral	-	+8	+9	2.8	0.80mm	#200-1812	#200-1822	#204-2212	#204-2222	
Cuspid w/ Hk	D	-2	+11	3	0.58mm	#200-18131	#200-18231	#204-22131	#204-22231	
1st/2nd Bi w/ DG Hk	D	-7	0	2.8	0.59mm	#200-18141D	#200-18241D	#204-22141D	#204-22241D	
MANDIBULAR	HK	TRQ	ANG	M/D	IN/OUT	.018 RIGHT	.018 LEFT	.022 RIGHT	.022 LEFT	
Lower Anteriors	-	0	0	2.3	0.78mm	#200-1831	Universal	#204-2231	Universal	
Cuspid w/ Hk	D	-11	+5	2.8	0.61mm	#200-18331	#200-18431	#204-22331	#204-22431	
1st/2nd Bi w/ DGI Hk	D	-17	0	2.8	0.64mm	#200-18341D	#200-18441D	#204-22341D	#204-22441D	
FULL SETS						.018 SLOT				
Upper/Lower 5x5 Hks on 3,4,5's						#200-R8-345				
						.022 SLOT				
						#204-R2-345				

the perfect combination of beauty and strength...

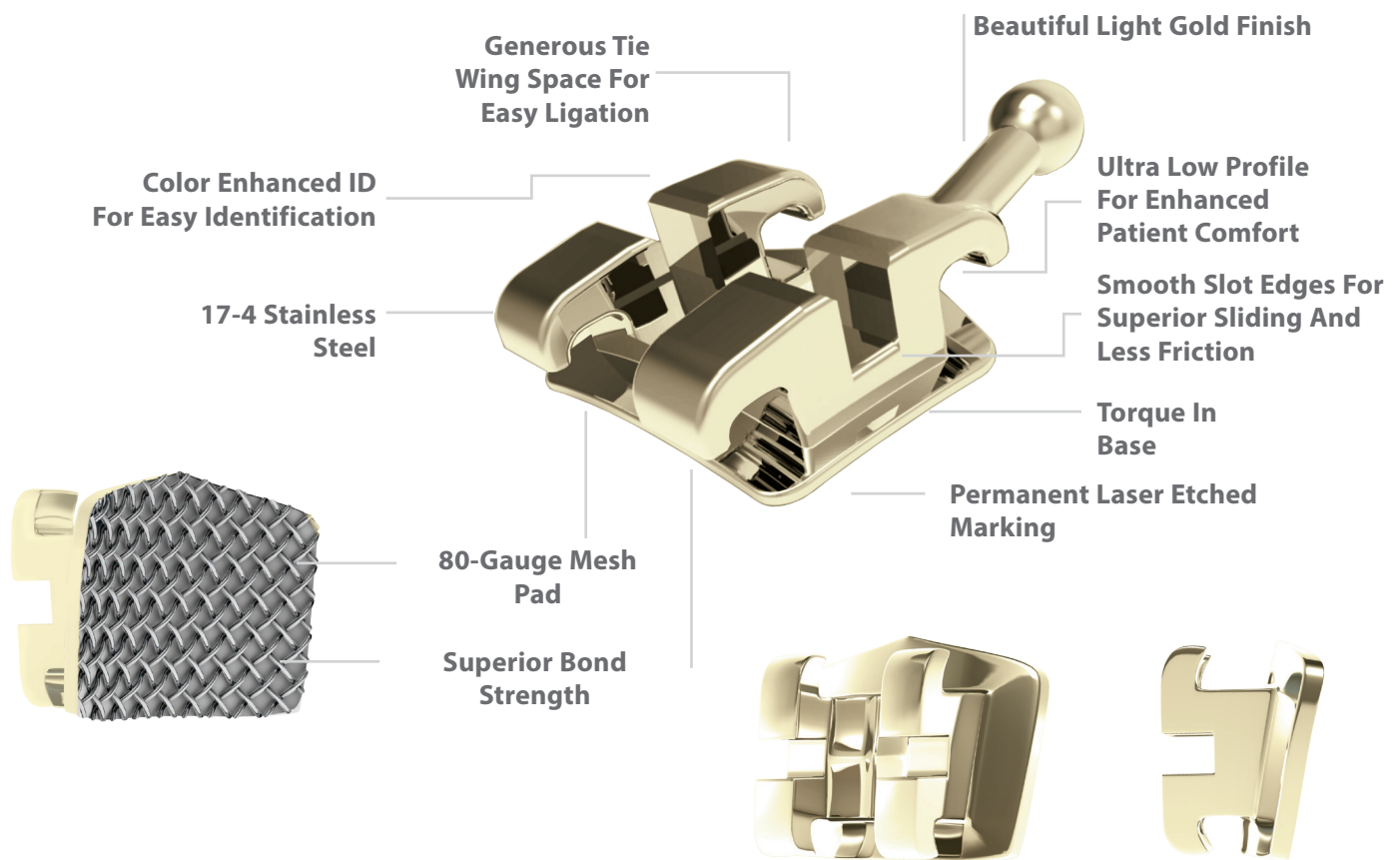

Atlas Mini Light Gold Bracket System - MBT

MAXILLARY	HK	TRQ	ANG	M/D	IN/OUT	.018 RIGHT	.018 LEFT	.022 RIGHT	.022 LEFT	
Central	-	+17	+4	3.1	0.4mm	#210-1811	#210-1821	#214-2211	#214-2221	
Lateral	-	+10	+8	2.8	0.78mm	#210-1812	#210-1822	#214-2212	#214-2222	
Cuspid w/ Hook	D	-7	+8	2.8	0.4mm	#210-18131	#210-18231	#214-22131	#214-22231	
1st/2nd Bi w/ DG Hk	D	-7	0	2.8	0.4mm	#210-18141D	#210-18241D	#214-22141D	#214-22241D	
MANDIBULAR	HK	TRQ	ANG	M/D	IN/OUT	.018 RIGHT	.018 LEFT	.022 RIGHT	.022 LEFT	
Lower Anteriors	-	-6	0	2.2	0.76mm	#210-1831	Universal	#214-2231	Universal	
Cuspid w/ Hk	D	-6	+3	2.8	0.4mm	#210-18331	#210-18431	#214-22331	#214-22431	
1st/2nd Bi w/ DG Hk	D	-12	+2	2.8	0.4mm	#210-18341D	#210-18441D	#214-22341D	#214-22441D	
FULL SETS						.018 SLOT		.022 SLOT		
Upper/Lower 5x5 Hks on 3,4,5's						#210-M8-345		#214-M2-345		

*DynaFlex® does not imply any endorsements from Drs. McLaughlin, Bennett and Trevisi and does not claim to be an exact duplicate of the MBT® system. MBT® is a registered trademark of 3M/Unitek Corporation. © Copyright 2021

Atlas Mini *Bright Gold* Bracket System

For a bolder look, try our Atlas Mini Bright Gold Brackets! With all the same great features of our Atlas Mini bracket along with the aesthetic and bold appeal of Bright Gold, your options have no limits with DynaFlex® bracket systems. The Bright Gold bracket retains all the strength and durability of the Atlas Mini as well as the ultra-smooth slot that improves sliding mechanics and enhances patient treatment time. Our exclusive coating process leaves a brilliant, smooth finish without the risk of abrasion or peeling off. Patients love these!

Available in .018 and .022 – Roth or MBT.



Atlas Mini Bright Gold Bracket System - Roth

MAXILLARY	HK	TRQ	ANG	M/D	IN/OUT	.018 RIGHT	.018 LEFT	.022 RIGHT	.022 LEFT		
Central	-	+12	+5	3.4	0.61mm	#2194G-11	#2194G-21	#2195G-11	#2195G-21		
Lateral	-	+8	+9	2.8	0.80mm	#2194G-12	#2194G-22	#2195G-12	#2195G-22		
Cuspid w/ Hk	D	-2	+11	3	0.58mm	#2194G-131	#2194G-231	#2195G-131	#2195G-231		
1st/2nd Bi w/ DG Hk	D	-7	0	2.8	0.59mm	#2194G-141D	#2194G-241D	#2195G-141	#2195G-241		
MANDIBULAR	HK	TRQ	ANG	M/D	IN/OUT	.018 RIGHT	.018 LEFT	.022 RIGHT	.022 LEFT		
Lower Anteriors	-	0	0	2.3	0.78mm	#2194G-31	Universal	#2195G-31	Universal		
Cuspid w/ Hook	D	-11	+5	2.8	0.61mm	#2194G-331	#2194G-431	#2195G-331	#2195G-431		
1st/2nd Bi w/ DG Hk	D	-17	0	2.8	0.64mm	#2194G-341D	#2194G-441D	#2195G-341	#2195G-441		
FULL SETS						.018 SLOT					.022 SLOT
Upper/Lower 5x5 Hks on 3,4,5's						#2194G-345					#2195G-345

Be Bold With Bright Gold

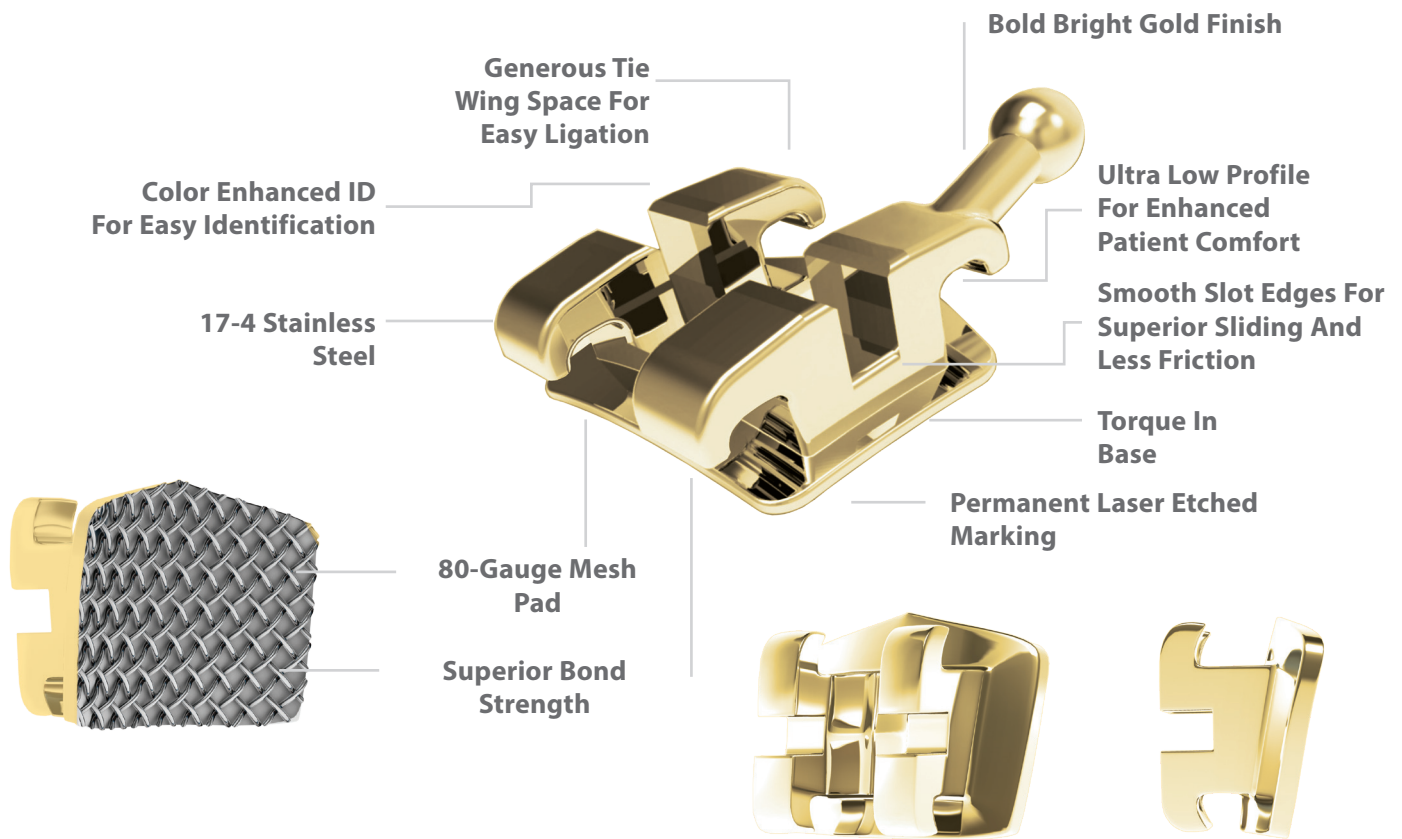

Atlas Mini Bright Gold Bracket System - MBT

MAXILLARY	HK	TRQ	ANG	M/D	IN/OUT	.018 RIGHT	.018 LEFT	.022 RIGHT	.022 LEFT		
Central	-	+12	+5	3.4	0.61mm	#2197G-11	#2197G-21	#2198G-11	#2198G-21		
Lateral	-	+8	+9	2.8	0.80mm	#2197G-12	#2197G-22	#2198G-12	#2198G-22		
Cuspid w/ Hook	D	-2	+11	3	0.58mm	#2197G-131	#2197G-231	#2198G-131	#2198G-231		
1st/2nd Bi w/ DG Hk	D	-7	0	2.8	0.59mm	#2197G-141D	#2197G-241D	#2198G-141	#2198G-241		
MANDIBULAR	HK	TRQ	ANG	M/D	IN/OUT	.018 RIGHT	.018 LEFT	.022 RIGHT	.022 LEFT		
Lower Anteriors	-	0	0	2.3	0.78mm	#2197G-31	Universal	#2198G-31	Universal		
Cuspid w/ Hook	D	-11	+5	2.8	0.61mm	#2197G-331	#2197G-431	#2198G-331	#2198G-431		
1st/2nd Bi w/ DG Hk	D	-17	0	2.8	0.64mm	#2197G-341D	#2197G-441D	#2198G-341	#2198G-441		
FULL SETS						.018 SLOT					.022 SLOT
Upper/Lower 5x5 Hks on 3,4,5's						#2197G-345					#2198G-345

*DynaFlex® does not imply any endorsements from Drs. McLaughlin, Bennett and Trevisi and does not claim to be an exact duplicate of the MBT® system. MBT® is a registered trademark of 3M/Unitek Corporation. © Copyright 2021

Atlas Standard

Bracket System

The Atlas Standard Profile bracket system offers the same features and benefits that our Atlas Mini provides. These standard profile brackets provide excellent bond strength and outstanding control and function. By offering a slightly larger base and with the mesial distal being similar to other larger brackets in the market, we can guarantee greater rotational control.

Available in .018 and .022 – Roth or MBT.



Atlas Standard



Atlas Mini



Size
Comparison



Atlas Standard Bracket System - Roth

MAXILLARY	REF	HK	TRQ	ANG	M/D	IN/OUT	.018 RIGHT	.018 LEFT	.022 RIGHT	.022 LEFT			
Central	UR ● UL ●	-	+12	+5	3.4	0.7mm	#202-R8-11	#202-R8-21	#202-R2-11	#202-R2-21			
Lateral	UR ● UL ●	-	+8	+9	2.9	1.08mm	#202-R8-12	#202-R8-22	#202-R2-12	#202-R2-22			
Cuspid	UR ● UL ●	-	-2	+11	3.0	0.7mm	#202-R8-13	#202-R8-23	#202-R2-13	#202-R2-23			
Cuspid w/ Hk	UR ● UL ●	D	-2	+11	3.0	0.7mm	#202-R8-131	#202-R8-231	#202-R2-131	#202-R2-231			
1st Bicuspid	UR ● UL ●	-	-7	0	2.9	0.7mm	#202-R8-14	#202-R8-24	#202-R2-14	#202-R2-24			
1st Bicuspid w/ Hk	UR ● UL ●	M	-7	0	2.9	0.7mm	#202-R8-141	#202-R8-241	#202-R2-141	#202-R2-241			
2nd Bicuspid	UR ● UL ●	-	-7	0	2.9	0.7mm	#202-R8-15	#202-R8-25	#202-R2-15	#202-R2-25			
2nd Bicuspid w/ Hk	UR ● UL ●	M	-7	0	2.9	0.7mm	#202-R8-151	#202-R8-251	#202-R2-151	#202-R2-251			
MANDIBULAR	REF	HK	TRQ	ANG	M/D	IN/OUT	.018 RIGHT	.018 LEFT	.022 RIGHT	.022 LEFT			
Central	LR ● LL ●	-	-1	+2	2.5	1.08mm	#202-R8-31	Universal	#202-R2-31	Universal			
Lateral	LR ● LL ●	-	-1	+2	2.5	1.08mm	#202-R8-32	#202-R8-42	#202-R2-32	#202-R2-42			
Cuspid	LR ● LL ●	-	-11	+5	2.9	0.7mm	#202-R8-33	#202-R8-43	#202-R2-33	#202-R2-43			
Cuspid w/ Hk	LR ● LL ●	D	-11	+5	2.9	0.7mm	#202-R8-331	#202-R8-431	#202-R2-331	#202-R2-431			
1st Bicuspid	LR ● LL ●	-	-17	0	2.9	0.7mm	#202-R8-34	#202-R8-44	#202-R2-34	#202-R2-44			
1st Bicuspid w/ Hk	LR ● LL ●	M	-17	0	2.9	0.7mm	#202-R8-341	#202-R8-441	#202-R2-341	#202-R2-441			
2nd Bicuspid	LR ● LL ●	-	-22	0	2.9	0.7mm	#202-R8-35	#202-R8-45	#202-R2-35	#202-R2-45			
2nd Bicuspid w/ Hk	LR ● LL ●	M	-22	0	2.9	0.7mm	#202-R8-351	#202-R8-451	#202-R2-351	#202-R2-451			
FULL SETS							.018 SLOT						
Upper/Lower 5x5 Hks on 3,4,5's							#202-R8-345						
											.022 RIGHT		
											#202-R2-345		

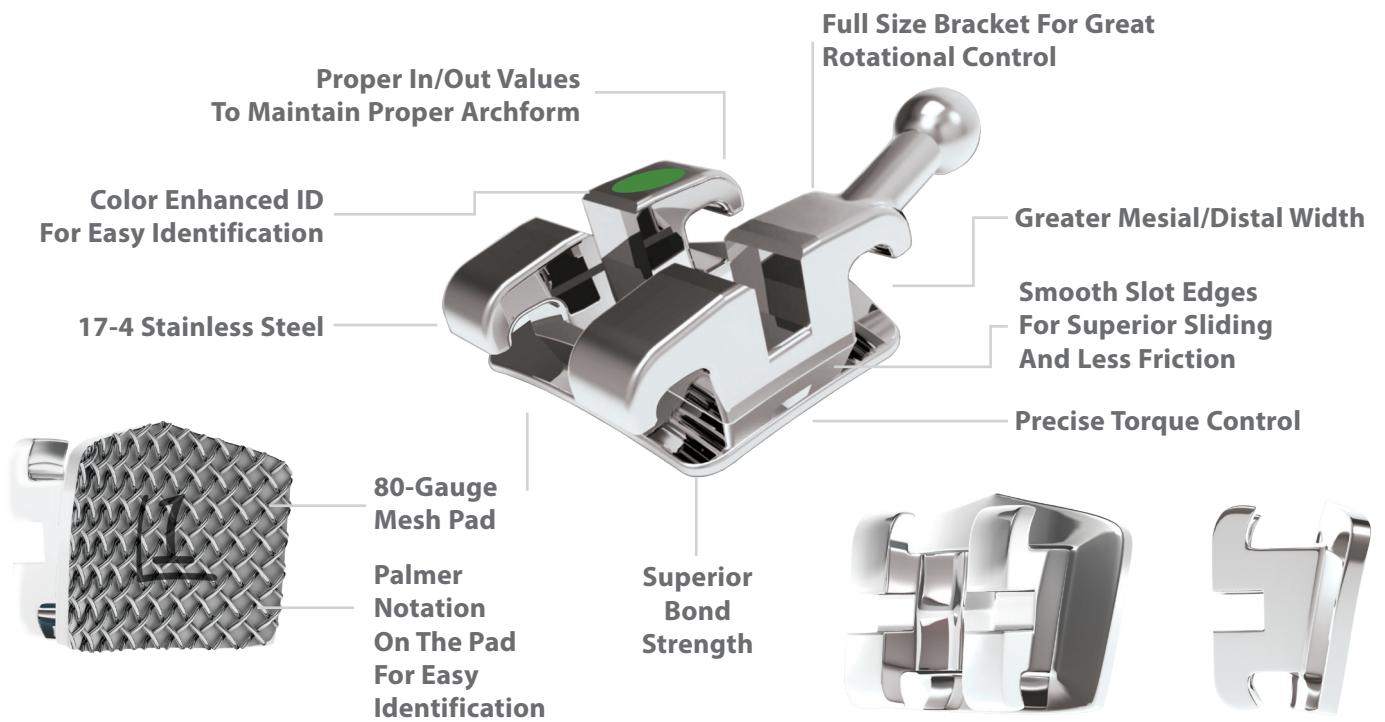

Atlas Standard Bracket System - MBT

MAXILLARY	REF	HK	TRQ	ANG	M/D	IN/OUT	.018 RIGHT	.018 LEFT	.022 RIGHT	.022 LEFT	
Central	UR ● UL ●	-	+17	+4	3.6	0.4mm	#202-M8-11	#202-M8-21	#202-M2-11	#202-M2-21	
Lateral	UR ● UL ●	-	+10	+8	2.8	0.78mm	#202-M8-12	#202-M8-22	#202-M2-12	#202-M2-22	
Cuspid	UR ● UL ●	-	-7	+8	3	0.4mm	#202-M8-13	#202-M8-23	#202-M2-13	#202-M2-23	
Cuspid w/ Hk	UR ● UL ●	D	-7	+8	3	0.4mm	#202-M8-131	#202-M8-231	#202-M2-131	#202-M2-231	
1st Bicuspid	UR ● UL ●	-	-7	0	3	0.4mm	#202-M8-14	#202-M8-24	#202-M2-14	#202-M2-24	
1st Bicuspid w/ Hk	UR ● UL ●	M	-7	0	3	0.4mm	#202-M8-141	#202-M8-241	#202-M2-141	#202-M2-241	
2nd Bicuspid	UR ● UL ●	-	-7	0	3	0.6mm	#202-M8-15	#202-M8-25	#202-M2-15	#202-M2-25	
2nd Bicuspid w/ Hk	UR ● UL ●	M	-7	0	3	0.6mm	#202-M8-151	#202-M8-251	#202-M2-151	#202-M2-251	
MANDIBULAR	REF	HK	TRQ	ANG	M/D	IN/OUT	.018 RIGHT	.018 LEFT	.022 RIGHT	.022 LEFT	
Central	LR ● LL ●	-	-6	0	2.7	0.78mm	#202-M8-31	Universal	#202-M2-31	Universal	
Lateral	LR ● LL ●	-	-6	0	2.7	0.78mm	#202-M8-32	#202-M8-42	#202-M2-32	#202-M2-42	
Cuspid	LR ● LL ●	-	-6	+3	3	0.4mm	#202-M8-33	#202-M8-43	#202-M2-33	#202-M2-43	
Cuspid w/ Hk	LR ● LL ●	D	-6	+3	3	0.4mm	#202-M8-331	#202-M8-431	#202-M2-331	#202-M2-431	
1st Bicuspid	LR ● LL ●	-	-12	+2	3	0.4mm	#202-M8-34	#202-M8-44	#202-M2-34	#202-M2-44	
1st Bicuspid w/ Hk	LR ● LL ●	M	-12	+2	3	0.4mm	#202-M8-341	#202-M8-441	#202-M2-341	#202-M2-441	
2nd Bicuspid	LR ● LL ●	-	-17	+2	3	0.4mm	#202-M8-35	#202-M8-45	#202-M2-35	#202-M2-45	
2nd Bicuspid w/ Hk	LR ● LL ●	M	-17	+2	3	0.4mm	#202-M8-351	#202-M8-451	#202-M2-351	#202-M2-451	
FULL SETS							.018 SLOT				
Upper/Lower 5x5 Hks on 3,4,5's							#202-M8-345				
							.022 SLOT				
							#202-M2-345				

*DynaFlex® does not imply any endorsements from Drs. McLaughlin, Bennett and Trevisi and does not claim to be an exact duplicate of the MBT® system. MBT® is a registered trademark of 3M/Unitek Corporation. © Copyright 2021

MTX™

MINI-TWIN EXTREME

Bracket System

Ensuring full control, torque is built into the base of each bracket and anatomically contoured (mesial-distal/occlusal-gingival) for accurate placement on each tooth. Brackets are engineered with precise angulation, placing the long axis of the root distal to the occlusal portion of the crown, allowing all the roots to align parallel. The anatomical contoured design allows precise bracket placement with all slots aligning at the end of the treatment. The upper centrals and laterals incline in a "plus" torque reading encouraging ideal contact point line-up and enhanced occlusion stability. Each bracket has optimum control to allow teeth to be free of rotations.

Available in .018 and .022 – Roth or MBT.



MTX™ Bracket System - Roth

MAXILLARY	REF	HK	TRQ	ANG	M/D	.018 RIGHT	.018 LEFT	.022 RIGHT	.022 LEFT		
Central	UR ● UL ●	-	+12	+5	3.5mm	#2501-11	#2501-21	#2500-11	#2500-21		
Lateral	UR ● UL ●	-	+8	+9	2.92mm	#2501-12	#2501-22	#2500-12	#2500-22		
Cuspid	UR ● UL ●	-	-2	+13	3.2mm	#2501-13	#2501-23	#2500-13	#2500-23		
Cuspid w/ Hk	UR ● UL ●	D	-2	+13	3.04mm	#2501-131	#2501-231	#2500-131	#2500-231		
1st/2nd Bicuspid	UR ● UL ●	-	-7	0	3mm	#2501-14	Universal	#2500-14	Universal		
1st/2nd Bicuspid w/ Hk	UR ● UL ●	M	-7	0	3mm	#2501-141	#2501-241	#2500-141	#2500-241		
MANDIBULAR	REF	HK	TRQ	ANG	M/D	.018 RIGHT	.018 LEFT	.022 RIGHT	.022 LEFT		
Anteriors	LR ● LL ●	-	-6	0	2.66mm	#2501-31	Universal	#2500-31	Universal		
Cuspid	LR ● LL ●	-	-6	+3	3.2mm	#2501-33	#2501-43	#2500-33	#2500-43		
Cuspid w/ Hk	LR ● LL ●	D	-6	+3	3.2mm	#2501-331	#2501-431	#2500-331	#2500-431		
1st Bicuspid	LR ○ LL ○	-	-12	+2	2.99mm	#2501-34	Universal	#2500-34	Universal		
1st Bicuspid w/ Hk	LR ○ LL ○	D	-12	+2	2.99mm	#2501-341	#2501-441	#2500-341	#2500-441		
2nd Bicuspid	LR ● LL ●	-	-17	+2	2.99mm	#2501-35	Universal	#2500-35	Universal		
2nd Bicuspid w/ Hk	LR ● LL ●	D	-17	+2	2.99mm	#2501-351	#2501-451	#2500-351	#2500-451		
FULL SETS						.018 SLOT					.022 SLOT
Upper/Lower 5x5 No Hks						#2501-NHK					#2500-NHK
Upper/Lower 5x5 Hks on 3's						#2501-3HK					#2500-3HK
Upper/Lower 5x5 Hks on 3,4,5's						#2501-345HK					#2500-345HK

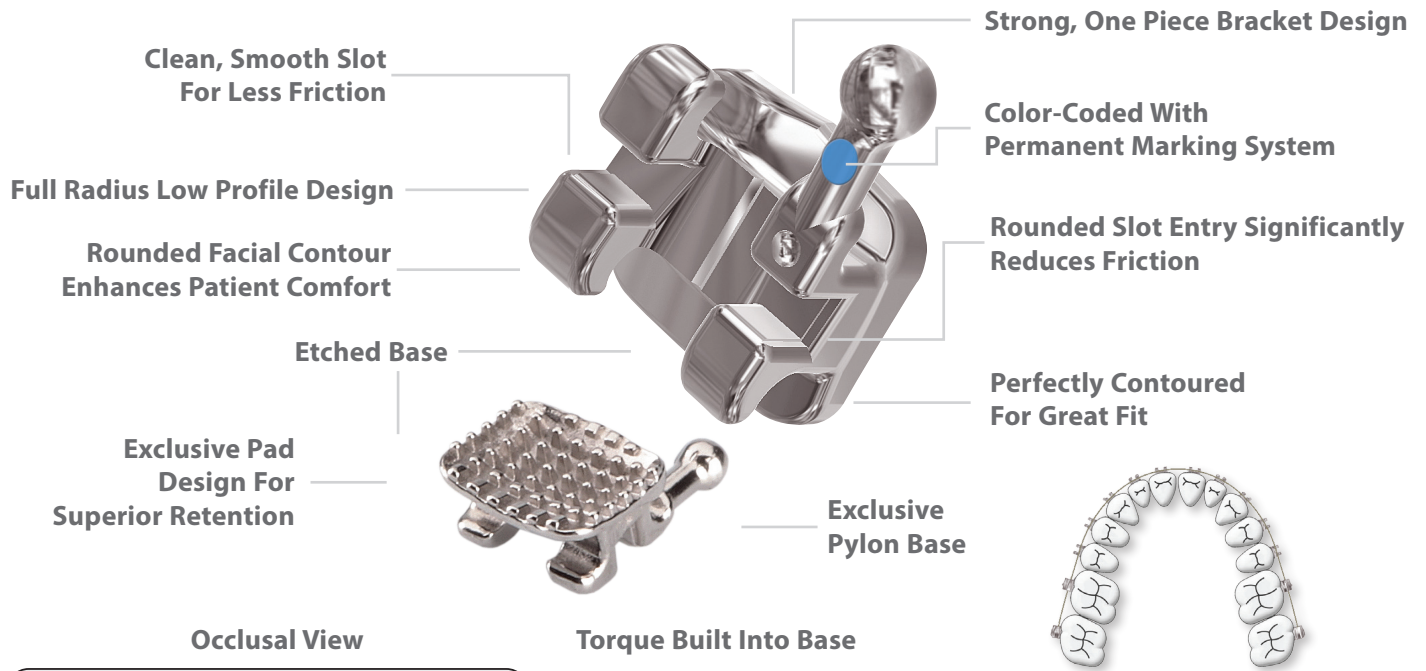

Combined Effort

Individual bracket thicknesses are built into each bracket and buccal tube (labial-lingual), reducing the need for first order in-out wire bends. The combination of these features easily allows for a flat curve of spee.

MTX™ Bracket System - MBT

MAXILLARY	REF	HK	TRQ	ANG	M/D	.018 RIGHT	.018 LEFT	.022 RIGHT	.022 LEFT
Central	UR ● UL ●	-	+12	+5	3.5mm	#2401-11	#2401-21	#2400-11	#2400-21
Lateral	UR ● UL ●	-	+8	+9	2.92mm	#2401-12	#2401-22	#2400-12	#2400-22
Cuspid	UR ● UL ●	-	-2	+13	3.2mm	#2401-13	#2401-23	#2400-13	#2400-23
Cuspid w/ Hook	UR ● UL ●	D	-2	+13	3.04mm	#2401-131	#2401-231	#2400-131	#2400-231
1st/2nd Bicuspid	UR ● UL ●	-	-7	0	3mm	#2401-14	Universal	#2400-14	Universal
1st/2nd Bicuspid w/ Hook	UR ● UL ●	M	-7	0	3mm	#2401-141	#2401-241	#2400-141	#2400-241
MANDIBULAR	REF	HK	TRQ	ANG	M/D	.018 RIGHT	.018 LEFT	.022 RIGHT	.022 LEFT
Anteriors	LR ● LL ●	-	0	0	2.66mm	#2401-31	Universal	#2400-31	Universal
Cuspid	LR ● LL ●	-	-11	+7	3.2mm	#2401-33	#2401-43	#2400-33	#2400-43
Cuspid w/ Hook	LR ● LL ●	D	-11	+7	3.2mm	#2401-331	#2401-431	#2400-331	#2400-431
1st Bicuspid	LR ● LL ●	-	-17	0	2.99mm	#2401-34	Universal	#2400-34	Universal
1st Bicuspid w/ Hook	LR ● LL ●	D	-17	0	2.99mm	#2401-341	#2401-441	#2400-341	#2400-441
2nd Bicuspid	LR ○ LL ○	-	-22	0	2.99mm	#2401-35	Universal	#2400-35	Universal
2nd Bicuspid w/ Hook	LR ○ LL ○	D	-22	0	2.99mm	#2401-351	#2401-451	#2400-351	#2400-451

*DynaFlex® does not imply any endorsements from Drs. McLaughlin, Bennett and Trevisi and does not claim to be an exact duplicate of the MBT® system. MBT® is a registered trademark of 3M/Unitek Corporation. © Copyright 2021

GEMINI™

Gemini™ Brackets are made from biocompatible 17-4 Grade Stainless Steel that yields a strong, durable bracket for long term treatment. Gemini™ Brackets offer the ultimate in full rotational control with their state-of-the-art base design that improves bracket placement and bond strength. Gemini™ Brackets have a compound-contoured base that is anatomically designed for an accurate fit. Available in standard and mini sizes.



Gemini™ Bracket System - Roth Standard

MAXILLARY	REF	HK	TRQ	ANG	.018 RIGHT	.018 LEFT	.022 RIGHT	.022 LEFT
Central	UR ● UL ●		+12	+5	#M-G8001	#M-G8002	#M-G2001	#M-G2002
Lateral	UR ● UL ●		+8	+9	#M-G8003	#M-G8004	#M-G2003	#M-G2004
Cuspid w/ Hk	UR ● UL ●	D	-2	+11	#M-G8007	#M-G8008	#M-G2007	#M-G2008
Upper Bi's	UR ● UL ●		-7	0	#M-G8010	#M-G8011	#M-G2010	#M-G2011
Upper Bicuspid w/ Hook	UR ● UL ●	M	-7	0	#M-G8013	#M-G8014	#M-G2013	#M-G2014
MANDIBULAR	REF	HK	TRQ	ANG	.018 RIGHT	.018 LEFT	.022 RIGHT	.022 LEFT
Lower Anteriors	LR ⊙ LL ⊙		-1	0	#M-G8020	Universal	#M-G2020	Universal
Cuspid w/ Hook	LR ● LL ●	D	-6	0	#M-G8023	#M-G8024	#M-G2023	#M-G2024
1st Bicuspid	LR ● LL ●		-17	0	#M-G8026	#M-G8027	#M-G2026	#M-G2027
1st Bicuspid w/ Hook	LR ● LL ●	M	-17	0	#M-G8028	#M-G8029	#M-G2028	#M-G2029
2nd Bicuspid	LR ● LL ●		-22	0	#M-G8031	#M-G8032	#M-G2031	#M-G2032
2nd Bicuspid w/ Hook	LR ● LL ●	M	-22	0	#M-G8033	#M-G8034	#M-G2033	#M-G2034

Gemini™ Bracket System - Roth Mini

MAXILLARY	REF	HK	TRQ	ANG	.018 RIGHT	.018 LEFT	.022 RIGHT	.022 LEFT
Central	UR ● UL ●		+12	+5	#M-GM8001	#M-GM8002	#M-G2M001	#M-G2M002
Lateral	UR ● UL ●		+8	+9	#M-GM8003	#M-GM8004	#M-G2M003	#M-G2M004
Cuspid w/ Hk	UR ● UL ●	D	-2	+11	#M-GM8007	#M-GM8008	#M-G2M007	#M-G2M008
Upper Bi's	UR ● UL ●		-7	0	#M-GM8010	#M-GM8011	#M-G2M010	#M-G2M011
Upper Bicuspid w/ Hook	UR ● UL ●	M	-7	0	#M-GM8013	#M-GM8014	#M-G2M013	#M-G2M014
MANDIBULAR	REF	HK	TRQ	ANG	.018 RIGHT	.018 LEFT	.022 RIGHT	.022 LEFT
Lower Anteriors	LR ⊙ LL ⊙		-1	0	#M-GM8020	Universal	#M-G2M020	Universal
Cuspid w/ Hook	LR ● LL ●	D	-6	0	#M-GM8023	#M-GM8024	#M-G2M023	#M-G2M024
1st Bicuspid	LR ● LL ●		-17	0	#M-GM8026	#M-GM8027	#M-G2M026	#M-G2M027
1st Bicuspid w/ Hook	LR ● LL ●	M	-17	0	#M-GM8028	#M-GM8029	#M-G2M028	#M-G2M029
2nd Bicuspid	LR ● LL ●		-22	0	#M-GM8031	#M-GM8032	#M-G2M031	#M-G2M032
2nd Bicuspid w/ Hook	LR ● LL ●	M	-22	0	#M-GM8033	#M-GM8034	#M-G2M033	#M-G2M034

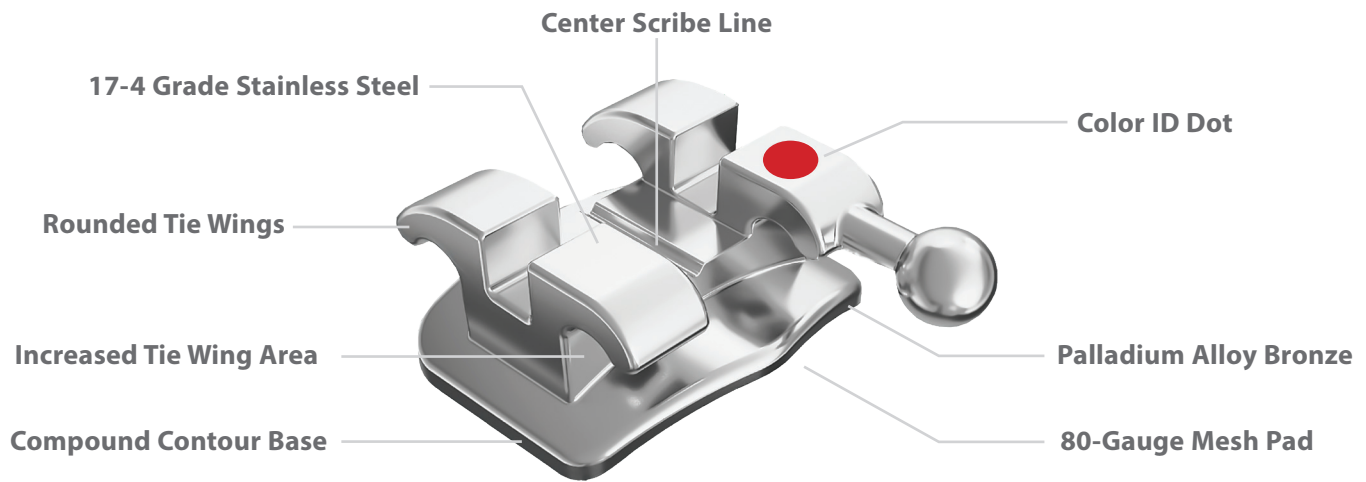

Gemini™ Bracket System - MBT Standard

MAXILLARY	REF	HK	TRQ	ANG	.018 RIGHT	.018 LEFT	.022 RIGHT	.022 LEFT
Central	UR ● UL ●		+17	5	#M-G8101	#M-G8102	#M-G2101	#M-G2102
Lateral	UR ● UL ●		+10	+8	#M-G8103	#M-G8104	#M-G2103	#M-G2104
Cuspid w/ Hk	UR ● UL ●	D	-7	0	#M-G8107	#M-G8108	#M-G2107	#M-G2108
Upper Bi's	UR ● UL ●		-7	0	#M-G8110	#M-G8111	#M-G2110	#M-G2111
Upper Bicuspid w/ Hook	UR ● UL ●	M	-7	0	#M-G8113	#M-G8114	#M-G2113	#M-G2114
MANDIBULAR	REF	HK	TRQ	ANG	.018 RIGHT	.018 LEFT	.022 RIGHT	.022 LEFT
Lower Anteriors	LR ○ LL ○		-6	0	#M-G8120	Universal	#M-G2120	Universal
Cuspid w/ Hook	LR ● LL ●	D	-6	+2	#M-G8123	#M-G8124	#M-G2123	#M-G2124
1st Bicuspid	LR ● LL ●		-12	+2	#M-G8126	#M-G8127	#M-G2126	#M-G2127
1st Bicuspid w/ Hook	LR ● LL ●	M	-12	+2	#M-G8128	#M-G8129	#M-G2128	#M-G2129
2nd Bicuspid	LR ● LL ●		-17	+2	#M-G8131	#M-G8132	#M-G2131	#M-G2132
2nd Bicuspid w/ Hook	LR ● LL ●	M	-17	+2	#M-G8133	#M-G8134	#M-G2133	#M-G2134

Gemini™ Bracket System - MBT Mini

MAXILLARY	REF	HK	TRQ	ANG	.018 RIGHT	.018 LEFT	.022 RIGHT	.022 LEFT
Central	UR ● UL ●		+17	5	#M-G8M101	#M-G8M1002	#M-G2M101	#M-G2M102
Lateral	UR ● UL ●		+10	+8	#M-G8M103	#M-G8M104	#M-G2M103	#M-G2M104
Cuspid w/ Hk	UR ● UL ●	D	-7	0	#M-G8M107	#M-G8M108	#M-G2M107	#M-G2M108
Upper Bi's	UR ● UL ●		-7	0	#M-G8M110	#M-G8M111	#M-G2M110	#M-G2M111
Upper Bicuspid w/ Hook	UR ● UL ●	M	-7	0	#M-G8M113	#M-G8M114	#M-G2M113	#M-G2M114
MANDIBULAR	REF	HK	TRQ	ANG	.018 RIGHT	.018 LEFT	.022 RIGHT	.022 LEFT
Lower Anteriors	LR ○ LL ○		-6	0	#M-G8M120	Universal	#M-G2M120	Universal
Cuspid w/ Hook	LR ● LL ●	D	-6	+2	#M-G8M123	#M-G8M124	#M-G2M123	#M-G2M124
1st Bicuspid	LR ● LL ●		-12	+2	#M-G8M126	#M-G8M127	#M-G2M126	#M-G2M127
1st Bicuspid w/ Hook	LR ● LL ●	M	-12	+2	#M-G8M128	#M-G8M129	#M-G2M128	#M-G2M129
2nd Bicuspid	LR ● LL ●		-17	+2	#M-G8M131	#M-G8M132	#M-G2M131	#M-G2M132
2nd Bicuspid w/ Hook	LR ● LL ●	M	-17	+2	#M-G8M133	#M-G8M134	#M-G2M133	#M-G2M134

Endurance®

SELF-LIGATING BRACKET SYSTEM

The all new Endurance® Self-Ligating Bracket System provides similar features to our traditional twin brackets with an integrated Nickel Titanium clip. The exceptional memory characteristic of NiTi ensures reliable operation without the risk of deformation throughout the entire length of treatment. The flexible clip will provide greater leveling and alignment during the early stages of treatment. Once the archwire is increased the bracket becomes active providing greater rotational control. With greater rotational and full archwire engagement, the friction or active part of the bracket will provide greater individual tooth control. The Endurance® Self-Ligating Bracket System delivers all the performance and control you would expect in a self-ligating appliance.

Available in Roth .018 and .022, or MBT .022.



Self-Ligating Instrument
#1444

*We recommend our Self-Ligating Instrument
for easy opening and closing of the bracket door.*

Endurance® Bracket System - Roth

MAXILLARY	REF	HK	TRQ	ANG	M/D	.018 RIGHT	.018 LEFT	.022 RIGHT	.022 LEFT	
Central	UR UL	-	+12	+5	.43mm	#605-1811	#605-1821	#610-2211	#610-2221	
Lateral	UR UL	-	+8	+9	.56mm	#605-1812	#605-1822	#610-2212	#610-2222	
Cuspid w/ Hk	UR UL	D	-2	+11	.41mm	#605-18131	#605-18231	#610-22131	#610-22231	
1st Bicuspid	UR UL	-	-7	0	.41mm	#605-1814	Universal	#610-2214	Universal	
1st Bicuspid w/ Hk	UR UL	D	-7	0	.41mm	#605-18141	#605-18241	#610-22141	#610-22241	
2nd Bicuspid	UR UL	-	-7	0	.41mm	#605-1815	Universal	#610-2215	Universal	
2nd Bicuspid w/ Hk	UR UL	D	-7	0	.41mm	#605-18151	#605-18251	#610-22151	#610-22251	
MANDIBULAR	REF	HK	TRQ	ANG	M/D	.018 RIGHT	.018 LEFT	.022 RIGHT	.022 LEFT	
Lower Anteriors	LR LL	-	0	0	.56mm	#605-1831	Universal	#610-2231	Universal	
Cuspid w/ Hk	LR LL	D	-11	+7	.41mm	#605-18331	#605-18431	#610-22331	#610-22431	
1st Bicuspid	LR LL	-	-17	0	.39mm	#605-1834	Universal	#610-2234	Universal	
1st Bicuspid w/ Hk	LR LL	D	-17	0	.39mm	#605-18341	#605-18441	#610-22341	#610-22441	
2nd Bicuspid	LR LL	-	-22	0	.39mm	#605-1835	Universal	#610-2235	Universal	
2nd Bicuspid w/ Hk	LR LL	D	-22	0	.39mm	#605-18351	#605-18451	#610-22351	#610-22451	
FULL SETS						.018 SLOT	.022 SLOT			
Upper/Lower 5x5 Hks on 3,4,5's						#605-R8-345	#610-R2-345			

Spring Tension Design
and exceptional memory properties of superelastic Ni-Ti ensure reliable operation without the risk of deformation

Full Slot Width
optimal rotational control

Smooth, Polished Finish
for greater patient comfort

Easy Operation
no special tool needed

Contour Base
for greater control and a precise fit

Tie Wing
ample undercuts for chains or ties

Mechanical Base
Laser technology for superior bonding with reliable and predictable debonding

Palmer Notation
Each bracket base is laser etched with a Palmer Notation to denote the quadrant

Interactive Control

The dynamic interaction between the ligating mechanism and the archwire enables the precise degree of control needed for each phase of treatment.

PASSIVE PHASE

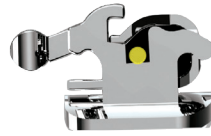

Small, round wires slide freely, minimizing archwire engagement and reducing friction facilitating efficient leveling and alignment.

INTERACTIVE PHASE

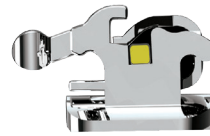

Small square or rectangular archwires fill the slot but do not reach the ligating mechanism. This adds control during the working phase for space closure and rotation control and arch form expression.

ACTIVE PHASE

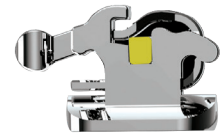

Larger rectangular archwires extend beyond the slot to fully engage the clip, facilitating active control for finishing and detailing.

Endurance® Bracket System - MBT

MAXILLARY	REF	HK	TRQ	ANG	M/D	.022 RIGHT	.022 LEFT	
Central	UR	-	+17	+4	.43mm	#700-2211	#700-2221	
	UL	-	+10	+8	.56mm	#700-2212	#700-2222	
Lateral	UR	D	-7	+8	.41mm	#700-22131	#700-22231	
	UL	-	-7	0	.41mm	#700-2214	Universal	
1st Bicuspid	UR	D	-7	0	.41mm	#700-22141	#700-22241	
1st Bicuspid w/ Hook	UR	-	-7	0	.41mm	#700-2215	#700-2225	
	UL	D	-7	0	.41mm	#700-22151	#700-22251	
2nd Bicuspid	UR	-	-7	0	.41mm	#700-22151	#700-22251	
2nd Bicuspid w/ Hook	UR	D	-7	0	.41mm	#700-22151	#700-22251	
	UL	-	-7	0	.41mm	#700-22151	#700-22251	
MANDIBULAR	REF	HK	TRQ	ANG	M/D	.022 RIGHT	.022 LEFT	
Lower Anteriors	LR	-	-6	0	.56mm	#700-2231	Universal	
	LL	-	-6	0	.56mm	#700-2231	Universal	
Cuspid w/ Hook	LR	D	-6	+3	.41mm	#700-22331	#700-22431	
	LL	-	-6	+3	.41mm	#700-22331	#700-22431	
1st Bicuspid	LR	-	-12	+2	.39mm	#700-2234	Universal	
	LL	-	-12	+2	.39mm	#700-2234	Universal	
1st Bicuspid w/ Hook	LR	D	-12	+2	.39mm	#700-22341	#700-22441	
	LL	-	-12	+2	.39mm	#700-22341	#700-22441	
2nd Bicuspid	LR	-	-17	+2	.39mm	#700-2235	Universal	
	LL	-	-17	+2	.39mm	#700-2235	Universal	
2nd Bicuspid w/ Hook	LR	D	-17	+2	.39mm	#700-22351	#700-22451	
	LL	-	-17	+2	.39mm	#700-22351	#700-22451	
FULL SETS				.022 RIGHT				.022 LEFT
Upper/Lower 5x5 Hooks on 3,4,5's				#700-M2-345				

*DynaFlex® does not imply any endorsements from Drs. McLaughlin, Bennett and Trevisi and does not claim to be an exact duplicate of the MBT® system. MBT® is a registered trademark of 3M/Unitek Corporation. © Copyright 2021

ClearViz+™ Mini Bracket System

This revolutionary Monocrystalline Sapphire bracket will forever change the way you look and think about clear brackets. The beauty of the ClearViz+™ Mini is that will you give up nothing in treatment and gain the patient satisfaction of using a crystal clear bracket. The endless features of ClearViz+™ Mini include; the superior strength and clarity of Monocrystalline Sapphire, Plasma silica coating for superior sliding mechanics and slot strength, 30% smaller size with perfectly rounded edges for uncompromising patient comfort, infinite bond strength throughout treatment, and the perfection of minimal fracture during debonding. As you can see, there is no equal to the ClearViz+™ Mini in aesthetic orthodontic treatment.



Available in .018 and .022 – Roth or MBT.

Debonding Tip:

Using a dull Pin & Ligature Cutter or Straight Bracket Removing plier. Grip bracket as close to the bracket pad as possible. Then gently rock back and forth to break adhesive bond.

Silicone Placement Guides
simplify bracket placement!

ClearViz+™ Mini Bracket System - Roth

MAXILLARY	REF	HK	TRQ	ANG	.018 RIGHT	.018 LEFT	.022 RIGHT	.022 LEFT		
Central	UR ● UL ●	-	+12	+5	#300-R8-11	#300-R8-21	#300-R2-11	#300-R2-21		
Lateral	UR ● UL ●	-	+8	+9	#300-R8-12	#300-R8-22	#300-R2-12	#300-R2-22		
Cuspid w/ Hk	UR ● UL ●	D	-2	+11	#300-R8-131	#300-R8-231	#300-R2-131	#300-R2-231		
1st Bicuspid	UR ● UL ●	-	-7	0	#300-R8-14	#300-R8-24	#300-R2-14	#300-R2-24		
1st Bicuspid w/ Hk	UR ● UL ●	D	-7	0	#300-R8-141	#300-R8-241	#300-R2-141	#300-R2-241		
2nd Bicuspid	UR ● UL ●	-	-7	0	#300-R8-15	#300-R8-25	#300-R2-15	#300-R2-25		
2nd Bicuspid w/ Hk	UR ● UL ●	D	-7	0	#300-R8-151	#300-R8-251	#300-R2-151	#300-R2-251		
MANDIBULAR	REF	HK	TRQ	ANG	.018 RIGHT	.018 LEFT	.022 RIGHT	.022 LEFT		
Lower Anteriors	LR ⊙ LL ⊙	-	-1	0	#300-R8-31	Universal	#300-R2-31	Universal		
Cuspid w/ Hk	LR ● LL ●	-	-11	+7	#300-R8-331	#300-R8-431	#300-R2-331	#300-R2-431		
1st Bicuspid	LR ● LL ●	-	-17	0	#300-R8-34	#300-R8-44	#300-R2-34	#300-R2-44		
1st Bicuspid w/ Hk	LR ● LL ●	D	-17	0	#300-R8-341	#300-R8-441	#300-R2-341	#300-R2-441		
2nd Bicuspid	LR ● LL ●	-	-22	0	#300-R8-35	#300-R8-45	#300-R2-35	#300-R2-45		
2nd Bicuspid w/ Hk	LR ● LL ●	D	-22	0	#300-R8-351	#300-R8-451	#300-R2-351	#300-R2-451		
FULL SETS					.018 SLOT					.022 SLOT
Upper/Lower 5x5 Hks on 3's					#300-R8-3					#300-R2-3
Upper/Lower 5x5 Hks on 3,4,5's					#300-R8-345					#300-R2-345

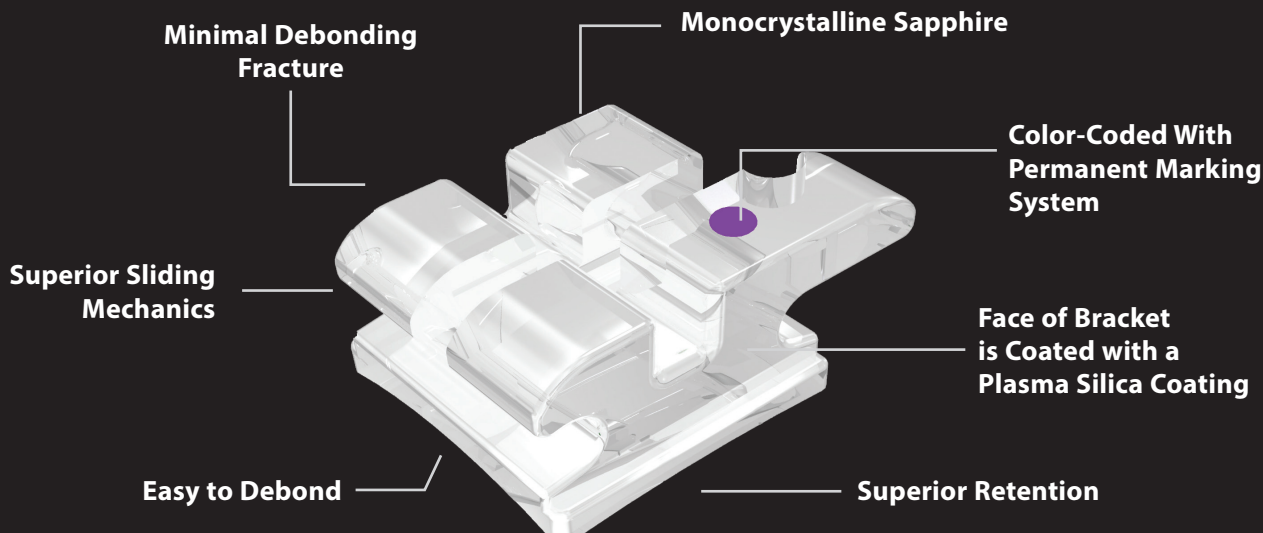

Super Clear, Substantially Smaller!

30% Smaller than the original ClearViz+

ClearViz+™ Mini Bracket System - MBT

MAXILLARY	REF	HK	TRQ	ANG	.018 RIGHT	.018 LEFT	.022 RIGHT	.022 LEFT
Central	UR ●	-	+17	+4	#300-M8-11	#300-M8-21	#300-M2-11	#300-M2-21
	UL ●							
Lateral	UR ●	-	+10	+8	#300-M8-12	#300-M8-22	#300-M2-12	#300-M2-22
	UL ●							
Cuspid w/ Hk	UR ●	D	-7	+8	#300-M8-131	#300-M8-231	#300-M2-131	#300-M2-231
	UL ●							
1st Bicuspid	UR ●	-	-7	0	#300-M8-14	#300-M8-24	#300-M2-14	#300-M2-24
	UL ●							
1st Bicuspid w/ Hk	UR ●	D	-7	0	#300-M8-141	#300-M8-241	#300-M2-141	#300-M2-241
	UL ●							
2nd Bicuspid	UR ●	-	-7	0	#300-M8-15	#300-M8-25	#300-M2-15	#300-M2-25
	UL ●							
2nd Bicuspid w/ Hk	UR ●	D	-7	0	#300-M8-151	#300-M8-251	#300-M2-151	#300-M2-251
	UL ●							
MANDIBULAR	REF	HK	TRQ	ANG	.018 RIGHT	.018 LEFT	.022 RIGHT	.022 LEFT
Lower Anteriors	LR ●	-	-6	0	#300-M8-31	Universal	#300-M2-31	Universal
	LL ●							
Cuspid w/ Hk	LR ●	-	0	+3	#300-M8-331	#300-M8-431	#300-M2-331	#300-M2-431
	LL ●							
1st Bicuspid	LR ●	-	-12	+2	#300-M8-34	#300-M8-44	#300-M2-34	#300-M2-44
	LL ●							
1st Bicuspid w/ Hk	LR ●	D	-12	+2	#300-M8-341	#300-M8-441	#300-M2-341	#300-M2-441
	LL ●							
2nd Bicuspid	LR ●	-	-17	+2	#300-M8-35	#300-M8-45	#300-M2-35	#300-M2-45
	LL ●							
2nd Bicuspid w/ Hk	LR ●	D	-17	+2	#300-M8-351	#300-M8-451	#300-M2-351	#300-M2-451
	LL ●							
FULL SETS					.018 SLOT		.022 SLOT	
Upper/Lower 5x5 Hks on 3's					#300-M8-3		#300-M2-3	
Upper/Lower 5x5 Hks on 3,4,5's					#300-M8-345		#300-M2-345	

*DynaFlex® does not imply any endorsements from Drs. McLaughlin, Bennett and Trevisi and does not claim to be an exact duplicate of the MBT® system. MBT® is a registered trademark of 3M/Unitek Corporation. © Copyright 2021

ClearViz+™

Bracket System

Manufactured of monocrystalline sapphire, these brackets are crystal clear! ClearViz+™ brackets are a low profile bracket with a high bond strength and are stain resistant.

Available in .018 and .022 – Roth or MBT.

Debonding Tip:

Using a dull Pin & Ligature Cutter or Straight Bracket Removing plier. Grip bracket as close to the bracket pad as possible. Then gently rock back and forth to break adhesive bond.



Crystal Clear...Stain Resistant!

ClearViz+™ Bracket System - Roth

MAXILLARY	REF	HK	TRQ	ANG	.018 RIGHT	.018 LEFT	.022 RIGHT	.022 LEFT
Central	UR ● UL ●	-	+12	+5	#2188-11	#2188-21	#2189-11	#2189-21
Lateral	UR ● UL ●	-	+8	+9	#2188-12	#2188-22	#2189-12	#2189-22
Cuspid	UR ● UL ●	-	-2	+11	#2188-13	#2188-23	#2189-13	#2189-23
Cuspid w/ Hk	UR ● UL ●	D	-2	+11	#2188-131	#2188-231	#2189-131	#2189-231
1st Bicuspid	UR ● UL ●	-	-7	0	#2188-14	Universal	#2189-14	Universal
1st Bicuspid w/ Hk	UR ● UL ●	D	-7	0	#2188-141	#2188-241	#2189-141	#2189-241
2nd Bicuspid	UR ● UL ●	-	-7	0	#2188-15	Universal	#2189-15	Universal
2nd Bicuspid w/ Hk	UR ● UL ●	D	-7	0	#2188-151	#2188-251	#2189-151	#2189-251
MANDIBULAR	REF	HK	TRQ	ANG	.018 RIGHT	.018 LEFT	.022 RIGHT	.022 LEFT
Lower Anteriors	LR ● LL ●	-	0	0	#2188-31	Universal	#2189-31	Universal
Cuspid	LR ● LL ●	-	-11	+5	#2188-33	#2188-43	#2189-33	#2189-43
Cuspid w/ Hk	LR ● LL ●	D	-11	+5	#2188-331	#2188-431	#2189-331	#2189-431
1st Bicuspid	LR ● LL ●	-	-17	0	#2188-34	Universal	#2189-34	Universal
1st Bicuspid w/ Hk	LR ● LL ●	D	-17	0	#2188-341	#2188-441	#2189-341	#2189-441
2nd Bicuspid	LR ● LL ●	-	-22	0	#2188-35	Universal	#2189-35	Universal
1st Bicuspid w/ Hk	LR ● LL ●	D	-22	0	#2188-351	#2188-451	#2189-351	#2189-451
FULL SETS			.018 SLOT		.022 SLOT			
Upper/Lower 5x5 No Hks			#2188-NHK		#2189-NHK			
Upper/Lower 5x5 Hks on 3's			#2188-3HK		#2189-3HK			
Upper/Lower 5x5 Hks on 3,4,5's			#2188-345HK		#2189-345HK			

aesthetic

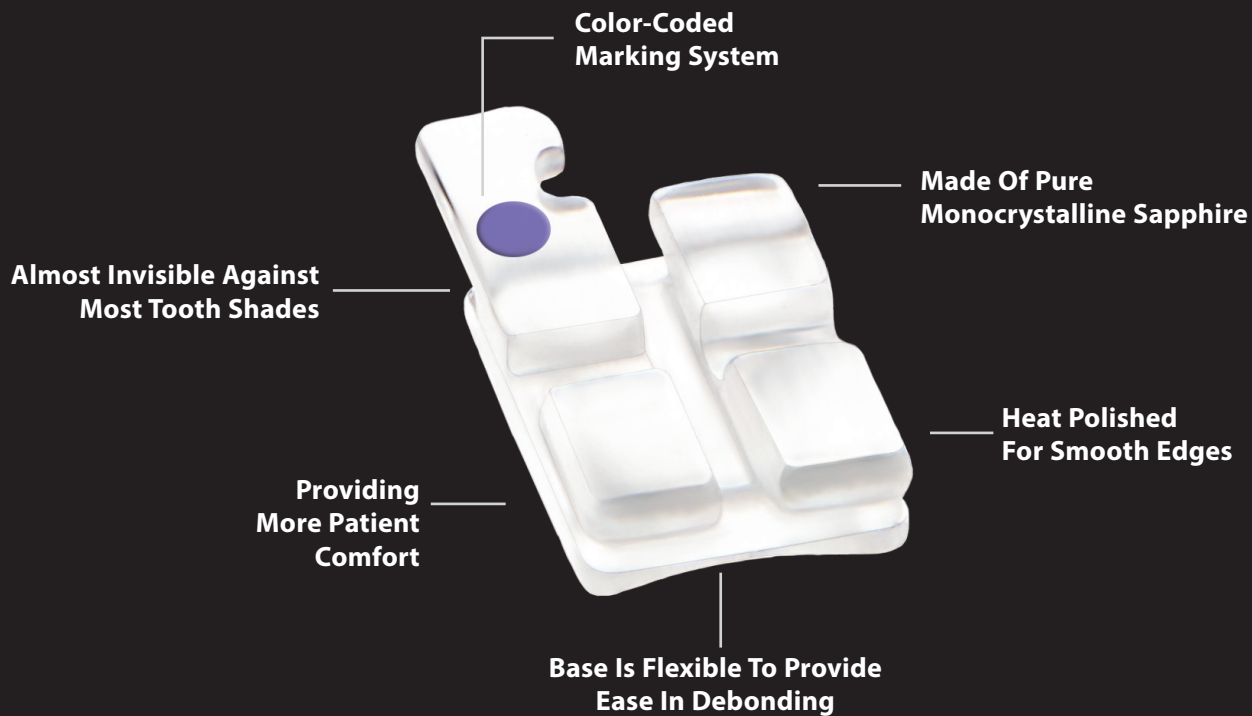

aesthetic

ClearViz+™ Bracket System - MBT

MAXILLARY	REF	HK	TRQ	ANG	.018 RIGHT	.018 LEFT	.022 RIGHT	.022 LEFT	
Central	UR ● UL ●	-	+17	+4	#2190-11	#2190-21	#2191-11	#2191-21	
Lateral	UR ● UL ●	-	+10	+8	#2190-12	#2190-22	#2191-12	#2191-22	
Cuspid	UR ● UL ●	-	-7	+8	#2190-13	#2190-23	#2191-13	#2191-23	
Cuspid w/ Hook	UR ● UL ●	D	-7	+8	#2190-131	#2190-231	#2191-131	#2191-231	
1st Bicuspid	UR ● UL ●	-	-7	0	#2190-14	Universal	#2191-14	Universal	
1st Bicuspid w/ Hook	UR ● UL ●	D	-7	0	#2190-141	#2190-241	#2191-141	#2191-241	
2nd Bicuspid	UR ● UL ●	-	-7	0	#2190-15	Universal	#2191-15	Universal	
2nd Bicuspid w/ Hook	UR ● UL ●	D	-7	0	#2190-151	#2190-251	#2191-151	#2191-251	
MANDIBULAR	REF	HK	TRQ	ANG	.018 RIGHT	.018 LEFT	.022 RIGHT	.022 LEFT	
Lower Anteriors	LR ● LL ●	-	-6	0	#2190-31	#Universal	#2191-31	Universal	
Cuspid	LR ● LL ●	-	-6	+3	#2190-33	#2190-43	#2191-33	#2191-43	
Cuspid w/ Hook	LR ● LL ●	D	-6	+3	#2190-331	#2190-431	#2191-331	#2191-431	
1st Bicuspid	LR ● LL ●	-	-12	+2	#2190-34	Universal	#2191-34	Universal	
1st Bicuspid w/ Hook	LR ● LL ●	D	-12	+2	#2190-341	#2190-441	#2191-341	#2191-441	
2nd Bicuspid	LR ● LL ●	-	-17	+2	#2190-35	Universal	#2191-35	Universal	
2nd Bicuspid w/ Hook	LR ● LL ●	D	-17	+2	#2190-351	#2190-451	#2191-351	#2191-451	
FULL SETS					.018 SLOT				.022 SLOT
Upper/Lower 5x5 No Hks					#2190-NHK				#2191-NHK
Upper/Lower 5x5 Hks on 3's					#2190-3HK				#2191-3HK
Upper/Lower 5x5 Hks on 3,4,5's					#2190-345HK				#2191-345HK

*DynaFlex® does not imply any endorsements from Drs. McLaughlin, Bennett and Trevisi and does not claim to be an exact duplicate of the MBT® system. MBT® is a registered trademark of 3M/Unitek Corporation. © Copyright 2021

ClearTek™ Mini

ClearTek™ Mini Brackets are manufactured using high quality Monocrystalline sapphire material. This material is ideal for bonding but also ideal for when removing brackets post treatment. The design of the slot reduces friction, even with the use of larger wires. Low profile with rounded edges provides excellent patient comfort with the results doctor's strive for. ClearTek™ Mini Brackets provide outstanding clarity and naturally blends with any tooth shade.

- Crystal clear monocrystalline sapphire
- Stain resistant
- High bond strength
- Easy debonding
- Low bracket profile



aesthetic

ClearTek™ Mini Bracket System - Roth

MAXILLARY	REF	HK	TRQ	ANG	.018 RIGHT	.018 LEFT	.022 RIGHT	.022 LEFT
Central	UR UL	-	+12	+5	#O-624-2000	#O-624-2002	#O-624-2100	#O-624-2102
Lateral	UR UL	-	+12	+5	#O-624-2004	#O-624-2006	#O-624-2104	#O-624-2106
Cuspid	UR UL	-	+8	+9	#O-624-2008	#O-624-2012	#O-624-2108	#O-624-2112
Cuspid w/ Hk	UR UL	D	+8	+9	#O-624-2010	#O-624-2014	#O-624-2110	#O-624-2114
1st Bicuspid	UR UL	-	0	+11	#O-624-2016	#O-624-2020	#O-624-2116	#O-624-2120
1st Bicuspid w/ Hk	UR UL	D	0	+11	#O-624-2018	#O-624-2022	#O-624-2118	#O-624-2122
2nd Bicuspid	UR UL	-	0	+11	#O-624-2024	#O-624-2028	#O-624-2124	#O-624-2128
2nd Bicuspid w/ Hk	UR UL	D	0	+11	#O-624-2026	#O-624-2029	#O-624-2126	#O-624-2129
MANDIBULAR	REF	HK	TRQ	ANG	.018 RIGHT	.018 LEFT	.022 RIGHT	.022 LEFT
Lower Anteriors	LR LL		0	0	#O-624-1030	Universal	#O-624-1130	Universal
Cuspid	LR LL		-11	+5	#O-624-1032	#O-624-1036	#O-624-1132	#O-624-1136
Cuspid w/ Hk	LR LL	D	-11	+5	#O-624-1034	#O-624-1038	#O-624-1134	#O-624-1138
1st Bicuspid	LR LL		-11	+5	#O-624-1040	#O-624-1044	#O-624-1140	#O-624-1144
1st Bicuspid w/ Hk	LR LL	D	-11	+5	#O-624-1042	#O-624-1046	#O-624-1142	#O-624-1146
2nd Bicuspid	LR LL		-17	0	#O-624-1048	#O-624-1052	#O-624-1148	#O-624-1152
2nd Bicuspid w/ Hk	LR LL	D	-17	0	#O-624-1050	#O-624-1054	#O-624-1150	#O-624-1154
FULL SETS			.018 SLOT		.022 SLOT			
5 x 5 U/L No Hks			#O-624-2030		#O-624-2130			
5 x 5 U/L Hks on 3 only			#O-624-2032		#O-624-2132			
5 x 5 U/L Hks on 3, 4, and 5			#O-624-2034		#O-624-2134			

Contoured Shape
For increased patient comfort

Mechanical Base System
Excellent bond strength
with coated base system

**Low Friction
Slot Design**

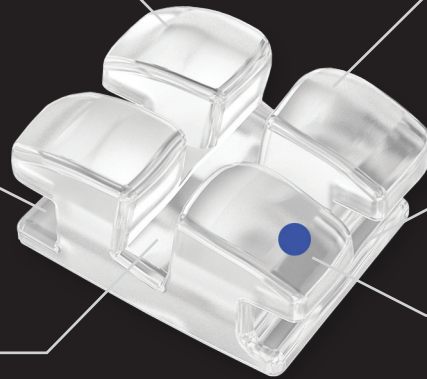































Super Clear Sapphire
99.998% Purity
Stain Free
Completely Transparent

Anatomical Base Shape
For accurate placement

**Color-Coded
Marking System**

aesthetic

ClearTek™ Mini Bracket System - MBT

MAXILLARY	REF	HK	TRQ	ANG	.018 RIGHT	.018 LEFT	.022 RIGHT	.022 LEFT
Central	UR  UL 		+17	+4	#O-626-2000	#O-626-2002	#O-626-2100	#O-626-2102
Lateral	UR  UL 		+17	+4	#O-626-2004	#O-626-2006	#O-626-2104	#O-626-2106
Cuspid	UR  UL 		+10	+8	#O-626-2008	#O-626-2012	#O-626-2108	#O-626-2112
Cuspid w/ Hk	UR  UL 	D	+10	+8	#O-626-2010	#O-626-2014	#O-626-2110	#O-626-2114
1st Bicuspid	UR  UL 		-7	0	#O-626-2016	#O-626-2020	#O-626-2116	#O-626-2120
1st Bicuspid w/ Hk	UR  UL 	D	-7	0	#O-626-2018	#O-626-2022	#O-626-2118	#O-626-2122
2nd Bicuspid	UR  UL 		-7	0	#O-626-2024	#O-626-2028	#O-626-2124	#O-626-2128
2nd Bicuspid w/ Hk	UR  UL 		-7	0	#O-626-2026	#O-626-2029	#O-626-2126	#O-626-2129
MANDIBULAR	REF	HK	TRQ	ANG	.018 RIGHT	.018 LEFT	.022 RIGHT	.022 LEFT
Lower Anteriors	LR  LL 		-6	0	#O-626-1030	Universal	#O-626-1130	Universal
Cuspid	LR  LL 		-6	+3	#O-626-1032	#O-626-1036	#O-626-1132	#O-626-1036
Cuspid w/ Hk	LR  LL 		-6	+3	#O-626-1034	#O-626-1038	#O-626-1134	#O-626-1038
1st Bicuspid	LR  LL 		-12	+2	#O-626-1040	#O-626-1044	#O-626-1140	#O-626-1044
1st Bicuspid w/ Hk	LR  LL 	D	-12	+2	#O-626-1042	#O-626-1046	#O-626-1142	#O-626-1046
2nd Bicuspid	LR  LL 		-17	+2	#O-626-1048	#O-626-1052	#O-626-1148	#O-626-1052
2nd Bicuspid w/ Hk	LR  LL 	D	-14	+2	#O-626-1050	#O-626-1054	#O-626-1150	#O-626-1054
FULL SETS					.018 SLOT		.022 SLOT	
5 x 5 U/L No Hks					#O-626-2030		#O-626-2130	
5 x 5 U/L Hks on 3 only					#O-626-2032		#O-626-2132	
5 x 5 U/L Hks on 3, 4, and 5					#O-626-2034		#O-626-2134	

*DynaFlex® does not imply any endorsements from Drs. McLaughlin, Bennett and Trevisi and does not claim to be an exact duplicate of the MBT® system. MBT® is a registered trademark of 3M/Unitek Corporation. © Copyright 2021

Krystal™ SL

Self-Ligating Bracket System

Introducing the new Krystal™ SL Bracket System! The Krystal™ SL is manufactured using a combination of copolymers and ceramics which create a translucent glass-like material for superior cosmetics and smooth finish for comfort. With torque in the base for excellent control, the clear clip provides enhanced aesthetics. Mechanical locking base with grooves allows for adhesive to be distributed easily along the bracket base. Bracket base is formulated to minimize breakage during debonding. This new innovative bracket has a super smooth surface which will not stain, break or flex during treatment. Easy to open and close for treatment, dependable, clear and comfortable, making the Krystal™ SL the perfect choice for both practices and patients!

Available in .018 and .022 – Roth or MBT.

Debonding Tip:

Using a dull Pin & Ligature Cutter or Straight Bracket Removing plier. Grip bracket as close to the bracket pad as possible. Then gently rock back and forth to break adhesive bond.



We recommend our Self-Ligating Instrument for easy opening and closing of the bracket door.



Self-Ligating Instrument
#1444

Krystal™ SL Bracket System - Roth

MAXILLARY	REF	HK	TRQ	ANG	ROTATION	.018 RIGHT	.018 LEFT	.022 RIGHT	.022 LEFT		
Central	UR UL	-	+12	+5	0	#400-8011	#400-8021	#400-2011	#400-2021		
Lateral	UR UL	-	+8	+9	0	#400-8012	#400-8022	#400-2012	#400-2022		
Cuspid	UR UL	-	-2	+8	+4	#400-8013	#400-8023	#400-2013	#400-2023		
Cuspid w/ Hk	UR UL	D	-2	+8	+4	#400-80131	#400-80231	#400-20131	#400-20231		
Bicuspid	UR UL	-	-7	0	0	#400-8014	Universal	#400-2014	Universal		
Bicuspid w/ Hk	UR UL	D	-7	0	0	#400-80141	#400-80241	#400-20141	#400-20241		
MANDIBULAR	REF	HK	TRQ	ANG	ROTATION	.018 RIGHT	.018 LEFT	.022 RIGHT	.022 LEFT		
Lower Anteriors	LR LL	-	0	0	0	#400-1831	Universal	#400-2031	Universal		
Cuspid	LR LL	-	-11	+5	+2	#400-1833	#400-1843	#400-2033	#400-2043		
Cuspid w/ Hk	LR LL	D	-11	+5	+2	#400-18331	#400-18431	#400-20331	#400-20431		
1st Bicuspid	LR LL	-	-17	0	0	#400-1834	#400-1844	#400-2034	#400-2044		
1st Bicuspid w/ Hk	LR LL	D	-17	0	0	#400-18341	#400-18441	#400-20341	#400-20441		
2nd Bicuspid	LR LL	-	-22	0	0	#400-1835	#400-1845	#400-2035	#400-2045		
2nd Bicuspid w/ Hk	LR LL	D	-22	0	0	#400-18351	#400-18451	#400-20351	#400-20451		
FULL SETS						.018 SLOT					.022 SLOT
Upper/Lower 5x5 Hks on 3's						#400-R8-3HK					#400-R2-3HK
Upper/Lower 5x5 Hks on 3,4,5's						#400-R8-345HK					#400-R2-345HK



Easy to use!

Place a tweezer or explorer onto the bracket, making sure the tool fits exactly in the door slot, pull the tool smoothly from the gingival to the occlusal and the door will open. Close the door using tweezers, tool or your fingers. Door is completely closed when you hear a "click".

Translucent Glass Appearance

Easy To Open Door

Round Door Slot

Mechanical Locking Base

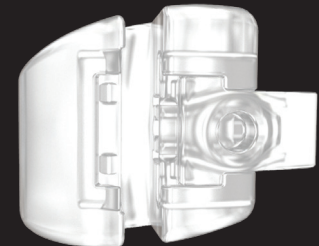
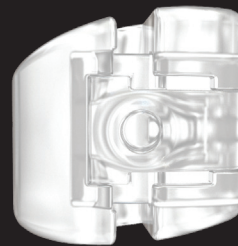
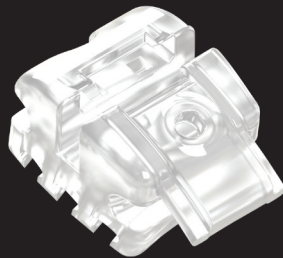
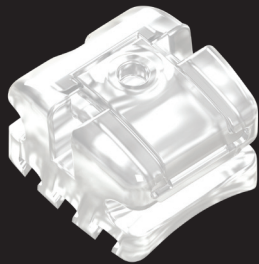
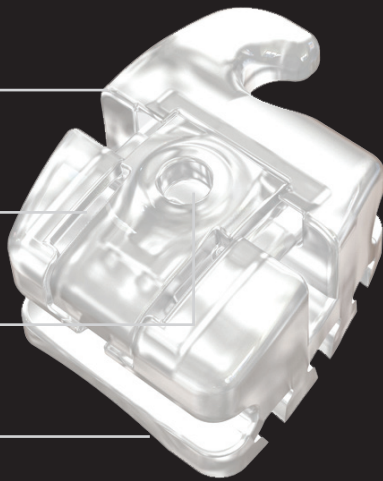

aesthetic

Krystal™ SL Bracket System - MBT

MAXILLARY	REF	HK	TRQ	ANG	ROTATION	.018 RIGHT	.018 LEFT	.022 RIGHT	.022 LEFT	
Central	UR ● UL ●	-	+17	+5	0	#500-1811	#500-1821	#500-2211	#500-2221	
Lateral	UR ● UL ●	-	+10	+8	0	#500-1812	#500-1822	#500-2212	#500-2222	
Cuspid	UR ● UL ●	-	0	+8	+4	#500-1813	#500-1823	#500-2213	#500-2223	
Cuspid w/ Hk	UR ● UL ●	D	0	+8	+4	#500-18131	#500-18231	#500-22131	#500-22231	
Bicuspid	UR ● UL ●	-	-7	0	0	#500-1814	Universal	#500-2214	Universal	
Bicuspid w/ Hk	UR ● UL ●	D	-7	0	0	#500-18141	#500-18241	#500-22141	#500-22241	
MANDIBULAR	REF	HK	TRQ	ANG	ROTATION	.018 RIGHT	.018 LEFT	.022 RIGHT	.022 LEFT	
Lower Anteriors	LR ● LL ●	-	-6	0	0	#500-1831	Universal	#500-2231	Universal	
Cuspid	LR ● LL ●	-	0	+3	+2	#500-1833	#500-1843	#500-2233	#500-2243	
Cuspid w/ Hk	LR ● LL ●	D	0	+3	+2	#500-18331	#500-18431	#500-22331	#500-22431	
1st Bicuspid	LR ● LL ●	-	-12	+2	0	#500-1834	#500-1844	#500-2234	#500-2244	
1st Bicuspid w/ Hk	LR ● LL ●	D	-12	+2	0	#500-18341	#500-18441	#500-22341	#500-22441	
2nd Bicuspid	LR ● LL ●	-	-17	+2	0	#500-1835	#500-1845	#500-2235	#500-2245	
2nd Bicuspid w/ Hk	LR ● LL ●	D	-17	+2	0	#500-18351	#500-18451	#500-22351	#500-22451	
FULL SETS						.018 SLOT				
Upper/Lower 5x5 Hks on 3's						#500-M8-3HK	#500-M2-3HK			
Upper/Lower 5x5 Hks on 3,4,5's						#500-M8-345HK	#500-M2-345HK			

*DynaFlex® does not imply any endorsements from Drs. McLaughlin, Bennett and Trevisi and does not claim to be an exact duplicate of the MBT® system. MBT® is a registered trademark of 3M/Unitek Corporation. © Copyright 2021

Krystal™

Ceramic Bracket System

Krystal™ Brackets are the choice for a true ceramic bracket! Manufactured from 99.9% pure alumina oxide, these polycrystalline brackets are non-staining and do not discolor. Krystal™ Brackets are a true twin design offering outstanding bond, high strength, precise tip and torque and are very easy to ligate. Your patients will be pleased with the comfort and aesthetic look!

Available in .018 and .022 – Roth or MBT.

Debonding Tip:

Using a dull Pin & Ligature Cutter or Straight Bracket Removing plier. Grip bracket as close to the bracket pad as possible. Then gently rock back and forth to break adhesive bond.



aesthetic

Krystal™ Bracket System - Roth

MAXILLARY	REF	HK	TRQ	ANG	.018 RIGHT	.018 LEFT	.022 RIGHT	.022 LEFT
Central	UR ● UL ●	-	+12	+5	#2180-11	#2180-21	#2181-11	#2181-21
Lateral	UR ● UL ●	-	+8	+9	#2180-12	#2180-22	#2181-12	#2181-22
Cuspid	UR ● UL ●	-	0	+11	#2180-13	#2180-23	#2181-13	#2181-23
Cuspid w/ Hk	UR ● UL ●	D	0	+11	#2180-131	#2180-231	#2181-131	#2181-231
1st/2nd Bicuspid	UR ● UL ●	-	-7	0	#2180-14	Universal	#2181-14	Universal
1st/2nd Bicuspid w/ Hk	UR ● UL ●	Univ.	-7	0	#2180-141	Universal	#2181-141	Universal
MANDIBULAR	REF	HK	TRQ	ANG	.018 RIGHT	.018 LEFT	.022 RIGHT	.022 LEFT
Lower Anteriors	LR ● LL ●	-	0	0	#2180-31	Universal	#2181-31	Universal
Cuspid	LR ● LL ●	-	-11	+5	#2180-33	#2180-43	#2181-33	#2181-43
Cuspid w/ Hk	LR ● LL ●	D	-11	+5	#2180-331	#2180-431	#2181-331	#2181-431
1st Bicuspid	LR ● LL ●	-	-17	0	#2180-34	Universal	#2181-34	Universal
1st Bicuspid w/ Hk	LR ● LL ●	Univ.	-17	0	#2180-341	Universal	#2181-341	Universal
2nd Bicuspid	LR ● LL ●	-	-22	0	#2180-35	Universal	#2181-35	Universal
2nd Bicuspid w/ Hk	LR ● LL ●	Univ.	-22	0	#2180-351	Universal	#2181-351	Universal
FULL SETS			.018 SLOT			.022 SLOT		
Upper/Lower 5x5 No Hks			#2180-NHK			#2181-NHK		
Upper/Lower 5x5 Hks on 3's			#2180-3HK			#2181-3HK		
Upper/Lower 5x5 Hks on 3,4,5's			#2180-345HK			#2181-345HK		

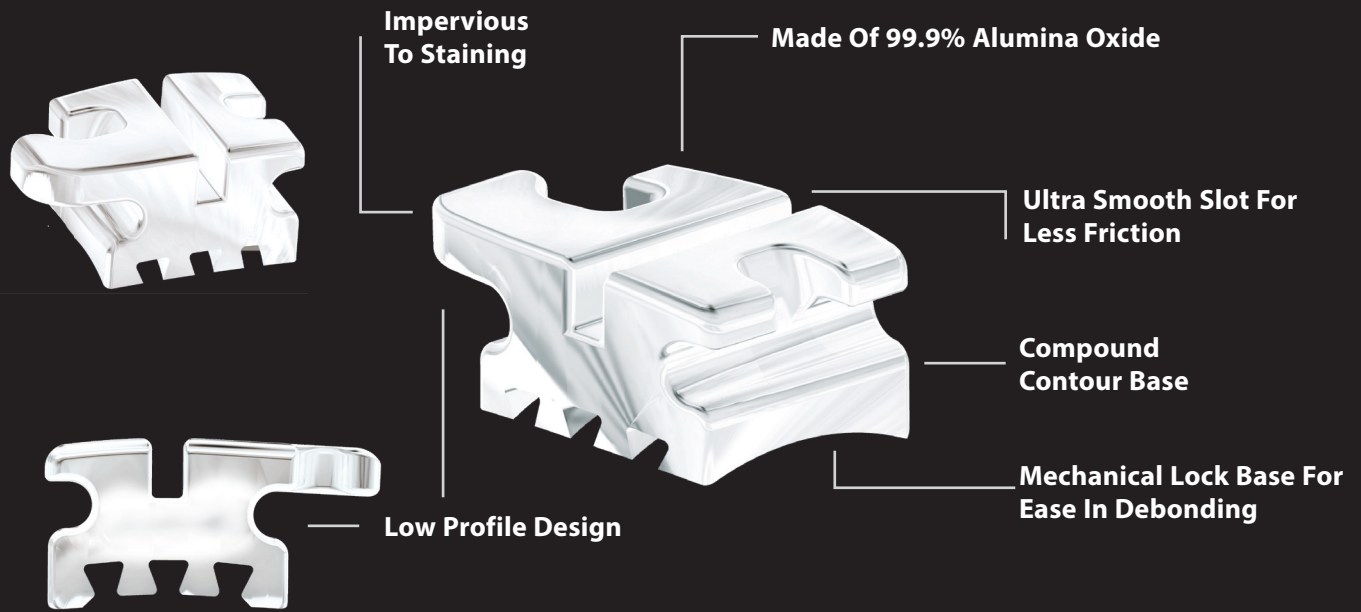

aesthetic

Krystal™ Bracket System - MBT

MAXILLARY	REF	HK	TRQ	ANG	.018 RIGHT	.018 LEFT	.022 RIGHT	.022 LEFT	
Central	UR ● UL ●	-	+17	+4	#2084-11	#2084-21	#2086-11	#2086-21	
Lateral	UR ● UL ●	-	+10	+8	#2084-12	#2084-22	#2086-12	#2086-22	
Cuspid	UR ● UL ●	-	0	+8	#2084-13	#2084-23	#2086-13	#2086-23	
Cuspid w/ Hk	UR ● UL ●	D	0	+8	#2084-131	#2084-231	#2086-131	#2086-231	
1st/2nd Bicuspid	UR ● UL ●	-	-7	0	#2084-14	Universal	#2086-14	Universal	
1st/2nd Bicuspid w/ Hk	UR ● UL ●	Univ.	-7	0	#2084-141	Universal	#2086-141	Universal	
MANDIBULAR	REF	HK	TRQ	ANG	.018 RIGHT	.018 LEFT	.022 RIGHT	.022 LEFT	
Lower Anteriors	LR ● LL ●	-	-6	0	#2084-31	#Universal	#2086-31	Universal	
Cuspid	LR ● LL ●	-	0	+3	#2084-33	#2084-43	#2086-33	#2086-43	
Cuspid w/ Hk	LR ● LL ●	D	0	+3	#2084-331	#2084-431	#2086-331	#2086-431	
1st Bicuspid	LR ● LL ●	-	-12	+2	#2084-34	Universal	#2086-34	Universal	
1st Bicuspid w/ Hk	LR ● LL ●	Univ.	-12	+3	#2084-341	Universal	#2086-341	Universal	
2nd Bicuspid	LR ● LL ●	-	-17	+2	#2084-35	Universal	#2086-35	Universal	
2nd Bicuspid w/ Hk	LR ● LL ●	Univ.	-17	+2	#2084-351	Universal	#2086-351	Universal	
FULL SETS					.018 SLOT				.022 SLOT
Upper/Lower 5x5 No Hks					#2084-NHK				#2086-NHK
Upper/Lower 5x5 Hks on 3's					#2084-3HK				#2086-3HK
Upper/Lower 5x5 Hks on 3,4,5's					#2084-345HK				#2086-345HK

*DynaFlex® does not imply any endorsements from Drs. McLaughlin, Bennett and Trevisi and does not claim to be an exact duplicate of the MBT™ system. MBT™ is a registered trademark of 3M/Unitek Corporation. © Copyright 2021

BANDS & ATTACHMENTS



Atlas 1st Molar Bands

The new Atlas Molar Bands have been designed for maximum retention and superior fit. The interproximal dimensions have been reduced for less tissue impingement and each band provides outstanding contour to both occlusal and gingival which reduces wash out. The occlusal edge of the band has been designed for increased strength in the seating process and the interior has been micro-etched for better retention. Half sizes are now available for proper fit and function.

** Band In Photo Shown With Tube As Example Only. Bands Are Sold Without Tubes, Tubes Sold Separately.*

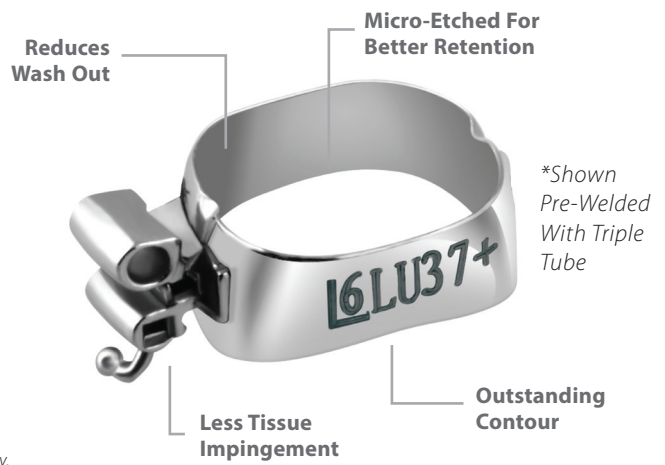

bands & attachments

SIZE	UR	UL	LR	LL	INTRO KIT	PRO KIT	MASTER KIT
29	#280-1290	#280-2290	#280-3290	#280-4290	2	4	8
29.5	#280-1295	#280-2295	#280-3295	#280-4295	2	4	8
30	#280-1300	#280-2300	#280-3300	#280-4300	2	4	8
30.5	#280-1305	#280-2305	#280-3305	#280-4305	2	4	8
31	#280-1310	#280-2310	#280-3310	#280-4310	2	4	8
31.5	#280-1315	#280-2315	#280-3315	#280-4315	2	4	8
32	#280-1320	#280-2320	#280-3320	#280-4320	4	8	16
32.5	#280-1325	#280-2325	#280-3325	#280-4325	4	8	16
33	#280-1330	#280-2330	#280-3330	#280-4330	6	12	24
33.5	#280-1335	#280-2335	#280-3335	#280-4335	8	16	32
34	#280-1340	#280-2340	#280-3340	#280-4340	8	16	32
34.5	#280-1345	#280-2345	#280-3345	#280-4345	10	20	40
35	#280-1350	#280-2350	#280-3350	#280-4350	10	20	40
35.5	#280-1355	#280-2355	#280-3355	#280-4355	10	20	40
36	#280-1360	#280-2360	#280-3360	#280-4360	12	24	48
36.5	#280-1365	#280-2365	#280-3365	#280-4365	10	20	40
37	#280-1370	#280-2370	#280-3370	#280-4370	10	20	40
37.5	#280-1375	#280-2375	#280-3375	#280-4375	8	16	32
38	#280-1380	#280-2380	#280-3380	#280-4380	6	12	24
38.5	#280-1385	#280-2385	#280-3385	#280-4385	4	8	16
39	#280-1390	#280-2390	#280-3390	#280-4390	4	8	16
39.5	#280-1395	#280-2395	#280-3395	#280-4395	4	8	16
40	#280-1400	#280-2400	#280-3400	#280-4400	2	4	8
40.5	#280-1405	#280-2405	#280-3405	#280-4405	2	4	8
41	#280-1410	#280-2410	#280-3410	#280-4410	2	4	8
41.5	#280-1415	#280-2415	#280-3415	#280-4415	2	4	8
42	#280-1420	#280-2420	#280-3420	#280-4420	2	4	8
42.5	#280-1425	#280-2425	#280-3425	#280-4425	2	4	8
43	#280-1430	#280-2430	#280-3430	#280-4430	2	4	8
43.5	#280-1435	#280-2435	#280-3435	#280-4435	2	4	8
44	#280-1440	#280-2440	#280-3440	#280-4440	2	4	8
44.5	#280-1445	#280-2445	#280-3445	#280-4445	2	4	8
					150 Bands	300 Bands	600 Bands
					75 RIGHTS 75 LEFTS	150 RIGHTS 150 LEFTS	300 RIGHTS 300 LEFTS

Ultra-Fit™ 1st Molar Bands

Ultra Fit™ Molar bands were designed with proper molar anatomy and form in mind. The DynaFlex® molar band has been manufactured to the highest standards of consistency and quality. The gingival rolled edges will reduce band wash-out. The reduced interproximal area ensures precise fit and maximum retention during cementation.

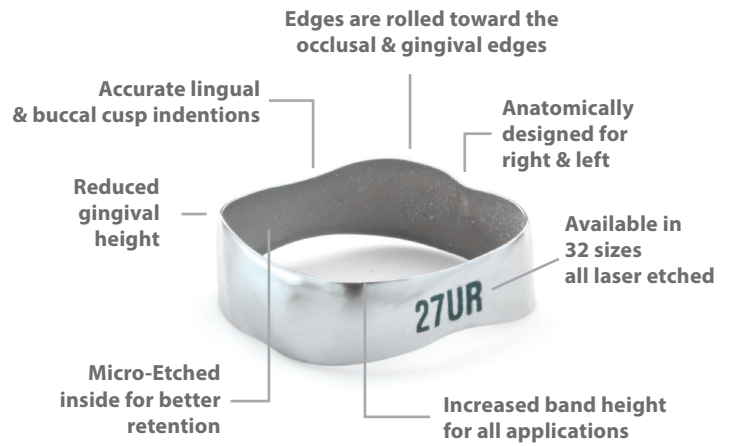

SIZE/ITEM #	UR	UL	LR	LL	INTRO KIT	PRO KIT	MASTER KIT
1	#301-0001	#302-0001	#303-0001	#304-0001	2	4	8
2	#301-0002	#302-0002	#303-0002	#304-0002	2	4	8
3	#301-0003	#302-0003	#303-0003	#304-0003	2	4	8
4	#301-0004	#302-0004	#303-0004	#304-0004	2	4	8
5	#301-0005	#302-0005	#303-0005	#304-0005	2	4	8
6	#301-0006	#302-0006	#303-0006	#304-0006	2	4	8
7	#301-0007	#302-0007	#303-0007	#304-0007	4	8	16
8	#301-0008	#302-0008	#303-0008	#304-0008	4	8	16
9	#301-0009	#302-0009	#303-0009	#304-0009	6	12	24
10	#301-0010	#302-0010	#303-0010	#304-0010	8	16	32
11	#301-0011	#302-0011	#303-0011	#304-0011	8	16	32
12	#301-0012	#302-0012	#303-0012	#304-0012	10	20	40
13	#301-0013	#302-0013	#303-0013	#304-0013	10	20	40
14	#301-0014	#302-0014	#303-0014	#304-0014	10	20	40
15	#301-0015	#302-0015	#303-0015	#304-0015	12	24	48
16	#301-0016	#302-0016	#303-0016	#304-0016	10	20	40
17	#301-0017	#302-0017	#303-0017	#304-0017	10	20	40
18	#301-0018	#302-0018	#303-0018	#304-0018	8	16	32
19	#301-0019	#302-0019	#303-0019	#304-0019	6	12	24
20	#301-0020	#302-0020	#303-0020	#304-0020	4	8	16
21	#301-0021	#302-0021	#303-0021	#304-0021	4	8	16
22	#301-0022	#302-0022	#303-0022	#304-0022	4	8	16
23	#301-0023	#302-0023	#303-0023	#304-0023	2	4	8
24	#301-0024	#302-0024	#303-0024	#304-0014	2	4	8
25	#301-0025	#302-0025	#303-0025	#304-0025	2	4	8
26	#301-0026	#302-0026	#303-0026	#304-0026	2	4	8
27	#301-0027	#302-0027	#303-0027	#304-0027	2	4	8
28	#301-0028	#302-0028	#303-0028	#304-0028	2	4	8
29	#301-0029	#302-0029	#303-0029	#304-0029	2	4	8
30	#301-0030	#302-0030	#303-0030	#304-0030	2	4	8
31	#301-0031	#302-0031	#303-0031	#304-0031	2	4	8
32	#301-0032	#302-0032	#303-0032	#304-0032	2	4	8
					150 Bands	300 Bands	600 Bands
					75 RIGHTS 75 LEFTS	150 RIGHTS 150 LEFTS	300 RIGHTS 300 LEFTS

Ultra-Fit™ 2nd Molar Bands

Ultra-Fit™ 2nd Molar Bands provide accurate adaptation and tooth anatomy. Buccal and lingual grooves provide excellent retention during trial fitting. Available in 34 sizes.

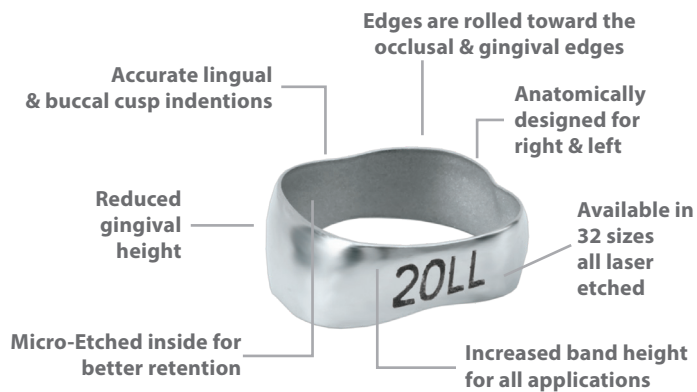

bands & attachments

SIZE	UR7	UL7	LR7	LL7	INTRO KIT	PRO KIT	MASTER KIT
3	#401-0003	#402-0003	#403-0003	#404-0003	2	2	4
4	#401-0004	#402-0004	#403-0004	#404-0004	2	2	4
5	#401-0005	#402-0005	#403-0005	#404-0005	2	2	4
6	#401-0006	#402-0006	#403-0006	#404-0006	2	2	4
7	#401-0007	#402-0007	#403-0007	#404-0007	2	2	4
8	#401-0008	#402-0008	#403-0008	#404-0008	2	2	6
9	#401-0009	#402-0009	#403-0009	#404-0009	2	4	6
10	#401-0010	#402-0010	#403-0010	#404-0010	2	4	8
11	#401-0011	#402-0011	#403-0011	#404-0011	2	4	8
12	#401-0012	#402-0012	#403-0012	#404-0012	4	6	8
13	#401-0013	#402-0013	#403-0013	#404-0013	4	6	14
14	#401-0014	#402-0014	#403-0014	#404-0014	4	6	14
15	#401-0015	#402-0015	#403-0015	#404-0015	4	6	14
16	#401-0016	#402-0016	#403-0016	#404-0016	4	6	14
17	#401-0017	#402-0017	#403-0017	#404-0017	4	8	14
18	#401-0018	#402-0018	#403-0018	#404-0018	4	8	14
19	#401-0019	#402-0019	#403-0019	#404-0019	4	8	14
20	#401-0020	#402-0020	#403-0020	#404-0020	4	8	14
21	#401-0021	#402-0021	#403-0021	#404-0021	4	8	14
22	#401-0022	#402-0022	#403-0022	#404-0022	4	6	14
23	#401-0023	#402-0023	#403-0023	#404-0023	4	6	14
24	#401-0024	#402-0024	#403-0024	#404-0024	4	6	14
25	#401-0025	#402-0025	#403-0025	#404-0025	4	6	14
26	#401-0026	#402-0026	#403-0026	#404-0026	4	6	8
27	#401-0027	#402-0027	#403-0027	#404-0027	4	4	8
28	#401-0028	#402-0028	#403-0028	#404-0028	2	4	8
29	#401-0029	#402-0029	#403-0029	#404-0029	2	4	6
30	#401-0030	#402-0030	#403-0030	#404-0030	2	2	6
31	#401-0031	#402-0031	#403-0031	#404-0031	2	2	6
32	#401-0032	#402-0032	#403-0032	#404-0032	2	2	4
33	#401-0033	#402-0033	#403-0033	#404-0033	2	2	4
34	#401-0034	#402-0034	#403-0034	#404-0034	2	2	4
35	#401-0035	#402-0035	#403-0035	#404-0035	2	2	4
36	#401-0036	#402-0036	#403-0036	#404-0036	2	2	4
					150 BANDS	300 BANDS	600 BANDS
					75 R 75 L	150 R 150 L	300 R 300 L

DynaFlex® Weldable Lingual Attachments

Lingual attachments to suit your every need!



Lug 3.8m
#2000

Lingual Cleat
#2001 5.3mm : #2001-05 8.1mm

Lingual Button
#2002

Wilson 3D
#2003

Sheath
#2004

Placement

Buccal Tube to Upper Molar

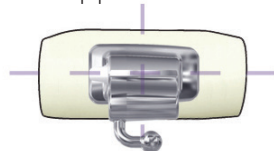

Upper Molar: Entrance to buccal tube will bisect the mesial/buccal cusp.

Buccal Tube to Lower Molar

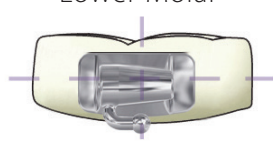

Lower Molar: Entrance to buccal tube will bisect the mesial/buccal cusp.

Lingual Attachments

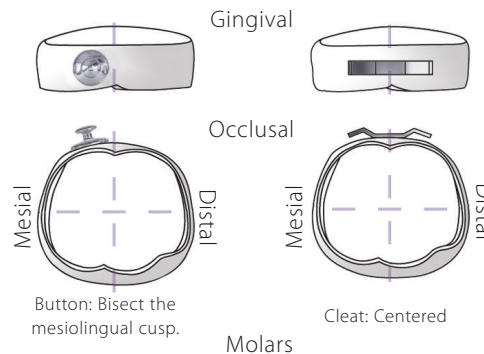

Please specify if you prefer a different position.

DynaFlex® Pedodontic Molar Bands

General purpose bands in pedodontic sizes. Completely festooned for easy and accurate fit every time. Narrow and seamless to accommodate both second primary and permanent molars. Bands are universal left to right and are available individually or in pre-packaged kits. Attachments available at additional charge.

Pre-Packaged Kits:

#230-001 Upper Pedo Molar Band Kit (60 bands; 10 each size)

#230-002 Lower Pedo Molar Band Kit (60 bands; 10 each size)

Individual Bands

SIZE	UPPER	LOWER
25	#230-125	#230-325
26	#230-126	#230-326
27	#230-127	#230-327
28	#230-128	#230-328
28.5	#230-128.5	#230-328.5
29	#230-129	#230-329



Purchase Individual Bands Or Kits

Ultra-Fit™ Bicuspid Bands

Ultra-Fit™ Upper & Lower Bicuspid Bands

Ultra-Fit™ Molar bands were designed with proper molar anatomy and form in mind. The DynaFlex® molar band has been manufactured to the highest standards of consistency and quality. The gingival rolled edges will reduce band wash-out. The reduced interproximal area ensures precise fit and maximum retention during cementation. Anatomically contoured to ensure a precise fit and maximum adaptation during cementation. Band size is permanently laser etched for easy identification, even after sterilization. Available individually or in pre-packaged kits, plain or pre-welded.

- **Ultra-Fit™ bicuspid band provides sufficient hardness to avoid collapsing when seated.**
- **DynaFlex® offers in-house custom welding on all bicuspid & molar bands with buccal attachments as well as lingual attachments. We use high-speed factory grade welders and skilled technicians to ensure optimum placement on all your custom welding. Custom welded orders are non-returnable.**
- **Universally shaped with true fit and accurate function. With distinctive shape and sizes, all bands are laser marked and have a full-size range for maximum retention.**

* Allow 14 business days for welding service.



**Upper Right
1st & 2nd Bicuspid
ITEM #501-00xx**

**Upper Left
1st & 2nd Bicuspid
ITEM #502-00xx**



**Lower Right
1st Bicuspid
ITEM #503-00xx**

**Lower Left
1st Bicuspid
ITEM #504-00xx**



**Lower Right
2nd Bicuspid
ITEM #505-00xx**

**Lower Left
2nd Bicuspid
ITEM #506-00xx**

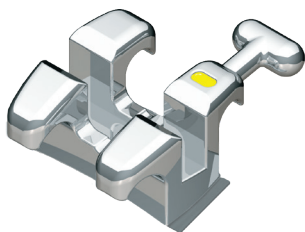

DynaFlex® Weldable Bicuspid Brackets - Roth Rx

Built to exact tolerances and finished with perfection guarantees outstanding performance in a weldable design.

MAXILLARY	WITH HOOK
Torque	-7
Angulation	0
Rotation	2
.018 Right	#741-0503
.018 Left	#740-0503
.022 Right	#741-0501
.022 Left	#740-0501

MANDIBULAR 1ST BI	WITH HOOK
Torque	-17
Angulation	0
Rotation	4
.018 Right	#741-1503
.018 Left	#740-1503
.022 Right	#741-1501
.022 Left	#740-1501

MANDIBULAR 2ND BI	WITH HOOK
Torque	-22
Angulation	0
Rotation	4
.018 Right	#741-1603
.018 Left	#740-1603
.022 Right	#741-1601
.022 Left	#740-1601

Ultra-Fit™ Bicuspid Bands

Purchase Individual Bands Or Kits

To Order Individual Bands:

Use the item numbers listed on opposite page to order individual bands, replace "xx" with desired size.



Laser Etched



Contoured Edges

SIZE	UPPER RIGHT 1ST & 2ND BI	UPPER LEFT 1ST & 2ND BI	LOWER RIGHT 1ST BI	LOWER LEFT 1ST BI	LOWER RIGHT 2ND BI	LOWER LEFT 2ND BI	INTRO KIT	PRO KIT	MASTER KIT
1	#501-0001	#502-0001	#503-0001	#504-0001	#505-0001	#506-0001	2	4	8
2	#501-0002	#502-0002	#503-0002	#504-0002	#505-0002	#506-0002	2	4	8
3	#501-0003	#502-0003	#503-0003	#504-0003	#505-0003	#506-0003	4	8	16
4	#501-0004	#502-0004	#503-0004	#504-0004	#505-0004	#506-0004	4	8	16
5	#501-0005	#502-0005	#503-0005	#504-0005	#505-0005	#506-0005	4	8	16
6	#501-0006	#502-0006	#503-0006	#504-0006	#505-0006	#506-0006	6	12	24
7	#501-0007	#502-0007	#503-0007	#504-0007	#505-0007	#506-0007	6	12	24
8	#501-0008	#502-0008	#503-0008	#504-0008	#505-0008	#506-0008	8	16	32
9	#501-0009	#502-0009	#503-0009	#504-0009	#505-0009	#506-0009	10	20	40
10	#501-0010	#502-0010	#503-0010	#504-0010	#505-0010	#506-0010	10	20	40
11	#501-0011	#502-0011	#503-0011	#504-0011	#505-0011	#506-0011	12	24	48
12	#501-0012	#502-0012	#503-0012	#504-0012	#505-0012	#506-0012	12	24	48
13	#501-0013	#502-0013	#503-0013	#504-0013	#505-0013	#506-0013	12	24	48
14	#501-0014	#502-0014	#503-0014	#504-0014	#505-0014	#506-0014	10	20	40
15	#501-0015	#502-0015	#503-0015	#504-0015	#505-0015	#506-0015	10	20	40
16	#501-0016	#502-0016	#503-0016	#504-0016	#505-0016	#506-0016	8	16	32
17	#501-0017	#502-0017	#503-0017	#504-0017	#505-0017	#506-0017	6	12	24
18	#501-0018	#502-0018	#503-0018	#504-0018	#505-0018	#506-0018	6	12	24
19	#501-0019	#502-0019	#503-0019	#504-0019	#505-0019	#506-0019	4	8	16
20	#501-0020	#502-0020	#503-0020	#504-0020	#505-0020	#506-0020	4	8	16
21	#501-0021	#502-0021	#503-0021	#504-0021	#505-0021	#506-0021	4	8	16
22	#501-0022	#502-0022	#503-0022	#504-0022	#505-0022	#506-0022	2	4	8
23	#501-0023	#502-0023	#503-0023	#504-0023	#505-0023	#506-0023	2	4	8
24	#501-0024	#502-0024	#503-0024	#504-0024	#505-0024	#506-0024	2	4	8
							150 Bands	300 Bands	600 Bands
							75 R 75 L	150 R 150 L	300 R 300 L

BUCCAL TUBES



Stability LP™

Low Profile Buccal Tubes - Bondable

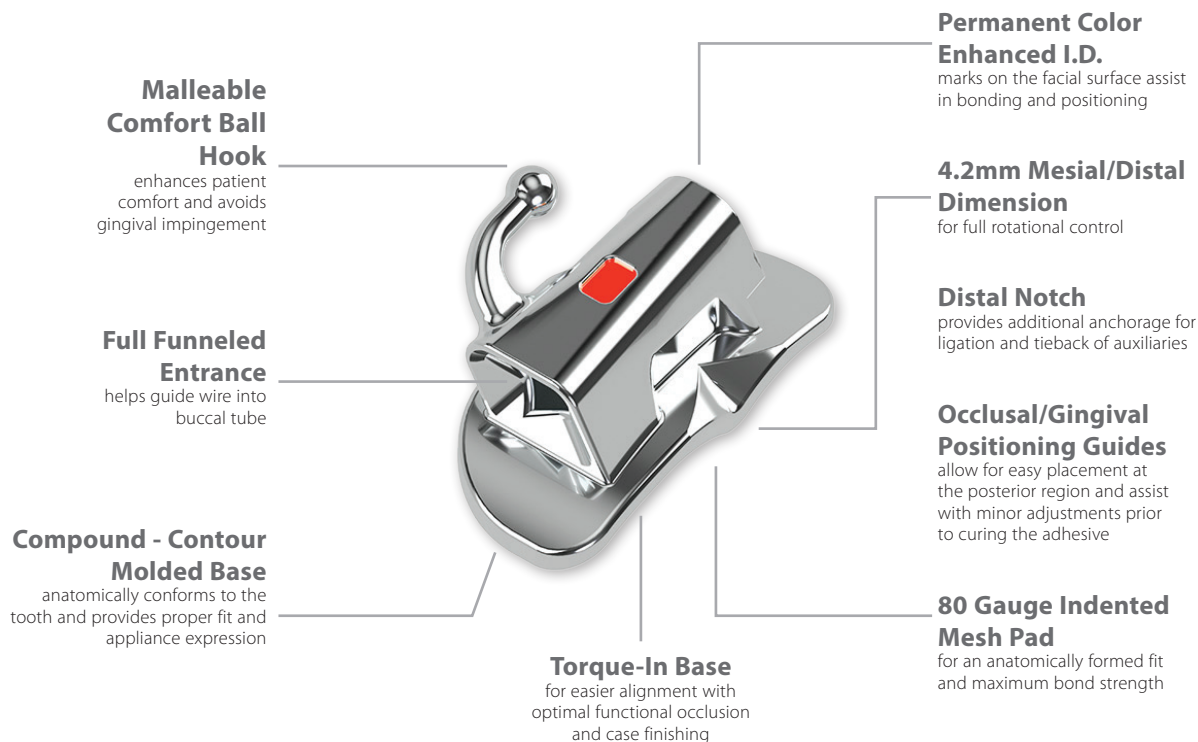

**Stability LP™
Bondable
Non-Convertible
Tubes**

MAXILLARY	TRQ	ROT	M/D	R/L	.018	.022
Standard	0	0	4.2mm	UR6,7	#701-0821E	#701-221E
Standard	0	0	4.2mm	UL6,7	#701-0822E	#701-222E
MBT	-14	10	4.2mm	UR6,7	#701-833E	#701-233E
MBT	-14	10	4.2mm	UL6,7	#701-834E	#701-234E
Roth	-10	8	4.2mm	UR6,7	#701-825E	#701-225E
Roth	-10	8	4.2mm	UL6,7	#701-826E	#701-226E
MANDIBULAR	TRQ	ROT	M/D	R/L	.018	.022
Standard	0	0	4.2mm	LR6,7	#701-0822E	#701-222E
Standard	0	0	4.2mm	LL6,7	#701-0821E	#701-221E
MBT	-20	0	4.2mm	LR6,7	#701-809E	#701-209E
MBT	-20	0	4.2mm	LL6,7	#701-810E	#701-210E
Roth	-25	5	4.2mm	LR6,7	#701-827E	#701-227E
Roth	-25	5	4.2mm	LL6,7	#701-828E	#701-228E

Stability™

Buccal Tubes

Comfort Is In The Design

Advanced casting technology allows for not only increased strength, but also the freedom of design to produce smaller precision tubes to increase clinical efficiency and patient comfort. Both occlusal interference and gingival impingement are reduced, and hygiene is improved. All convertible tubes incorporate a true "twin" bracket tie wing design to aid in ligation. Our combination tubes also incorporate a distinctive tie wing design for secure ligation following archwire slot conversion, and are offset from the gingival to avoid tissue impingement.

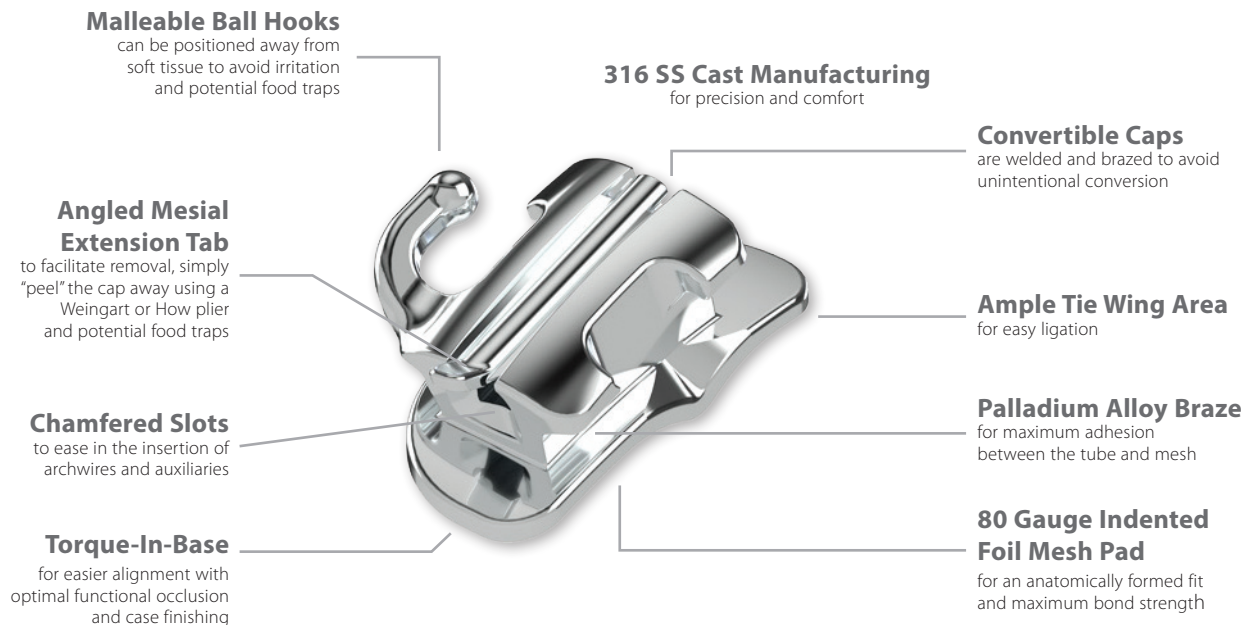

Our Stability™ Buccal Tube line offers miniaturized cast buccal tubes with rounded surfaces for exceptional patient comfort and acceptance.

Available in Bondable or Weldable

All Stability Buccal Tubes are available in a Weldable or Bondable base. Weld your own buccal tubes in your office or allow us to weld for you. complimentary welding service is no extra charge. Please allow 14 business days for welding services. Pre-welded band assemblies are custom and are non-returnable.

See Pages 64-65 For Further Information

Stability™ Maxillary Buccal Tubes - Bondable

All of our buccal tubes are made to exacting standards, sacrificing nothing to give you the best product available. You will find Stability™ to be a quality product beyond compare. There are many variations to consider, please call and let us help you find the perfect prescription for your office.

MAXILLARY		RX	TRQ	ROT	M/D	R/L	.018	.022
	Single Convertible Buccal Tube	Roth	-10	+8	3.5mm	UR6	#601-007	#601-107
		Roth	-10	+8	3.5mm	UL6	#601-008	#601-108
		–	-10	0	3.5mm	UR6	#701-007	#701-107
		–	-10	0	3.5mm	UL6	#701-008	#701-108
	1st/2nd Molar Non-Convertible Buccal Tube	Roth	-10	+8	3.5mm	UR6/7	#601-013	#601-113
		Roth	-10	+8	3.5mm	UL6/7	#601-014	#601-114
		Standard	0	0	3.5mm	UR6/7	#701-013	#701-113
		Standard	0	0	3.5mm	UL6/7	#701-014	#701-114
		MBT	-14	+10	3.5mm	UR6/7	#801-013	#801-113
		MBT	-14	+10	3.5mm	UL6/7	#801-014	#801-114
	Single Non-Convertible Buccal Tube Small Pad	Roth	-10	+8	3.5mm	UR6/7	#601-013B	#601-113B
		Roth	-10	+8	3.5mm	UL6/7	#601-014B	#601-114B
		MBT	-14	+10	3.5mm	UR6/7	#801-013B	#801-113B
		MBT	-14	+10	3.5mm	UL6/7	#801-014B	#801-114B
		Standard	0	0	3.5mm	UR6/7	#701-013B	#701-113B
		Standard	0	0	3.5mm	UL6/7	#701-014B	#701-114B

Mini Single Buccal Tubes - 10 Pack

- Comfort hook, for optimal patient comfort compound contoured.
- Torque in base trumpeted shape.
- Archwire slot for easy insertion metal injection molded.
- Non-convertible cap means no cap failure.
- Rounded edges, for patient comfort.
- Superior base, for stronger bonds.
- Mesial/distal dimensions: 2.41mm.

UPPER	.018	.022	TRQ	ROT	IN/OUT
UR or LL	#O-600-1500	#O-600-1550	0	0	.023mm
UL or LR	#O-600-1502	#O-600-1552	0	0	.023mm
Right	#O-600-1504	#O-600-1554	-10	0	.023mm
Left	#O-600-1506	#O-600-1556	-10	0	.023mm
UR or LL	#O-600-1510	#O-600-1558	-12	0	.023mm
UL or LR	#O-600-1512	#O-600-1560	-12	0	.023mm
Right	#O-600-1514	#O-600-1562	-25	0	.023mm
Left	#O-600-1516	#O-600-1564	-25	0	.023mm



Stability™ Mandibular Buccal Tubes - Bondable

All of our buccal tubes are made to exacting standards, sacrificing nothing to give you the best product available. You will find Stability™ to be a quality product beyond compare. There are many variations to consider, please call and let us help you find the perfect prescription for your office.

MANDIBULAR		RX	TRQ	ROT	M/D	R/L	.018	.022
	Single Convertible Buccal Tube	Roth	-25	+5	3.5mm	LR6	#601-021	#601-121
		Roth	-25	+5	3.5mm	LL6	#601-022	#601-122
		MBT	-20	0	3.5mm	LR6	#701-021	#701-121
		MBT	-20	0	3.5mm	LL6	#701-022	#701-122
	1st/2nd Molar Non-Convertible Buccal Tube	Roth	-25	+5	3.5mm	LR6/7	#601-031	#601-131
		Roth	-25	+5	3.5mm	LL6/7	#601-032	#601-132
		-	-10	0	3.5mm	LR6/7	#701-031	#701-131
		-	-10	0	3.5mm	LL6/7	#701-032	#701-132
		Standard	0	0	3.5mm	LR6/7	#801-031	#801-131
		Standard	0	0	3.5mm	LL6/7	#801-032	#801-132
	Single Non-Convertible Buccal Tube Small Pad	Roth	-25	+5	3.5mm	LR6/7	#601-031B	#601-131B
		Roth	-25	+5	3.5mm	LL6/7	#601-032B	#601-132B
		Standard	0	0	3.5mm	LR6/7	#801-031B	#801-131B
		Standard	0	0	3.5mm	LL6/7	#801-032B	#801-132B
		-	-10	0	3.5mm	LR6/7	#701-031B	#701-131B
		-	-10	0	3.5mm	LL6/7	#701-032B	#701-132B

Stability™ 2nd Molar Minitubes Bondable

These second molar Minitubes deliver superior performance while being very small! MIM construction with smooth contours and an ultra low profile design. Openings are funneled and enhanced to make wire insertion a breeze. Pylon base and color coded for simple identification. Instrument notches for secure grip and easy positioning. Anatomical notch provides easy positioning. Pack of 10.







TRQ	ANG.	TOOTH	.018	.022
0	0	UR	#720-1000	#725-1000
0	0	UL	#720-1001	#725-1050
0	0	LR	#720-1050	#725-1051
0	0	LL	#720-1051	#725-1001
-10	0	UR	#720-2000	#725-2000
-10	0	UL	#720-2050	#725-2050
-14	0	UR	#720-3000	#725-3000
-14	0	UL	#720-3001	#725-3001
-14	0	LR	#720-3050	#725-3051
-14	0	LL	#720-3051	#725-3050
-25	0	LR	#720-4000	#725-4000
-25	0	LL	#720-4050	#725-4050

Stability™

Maxillary Buccal Tubes - Weldable

Weldable All of our buccal tubes are made to exacting standards, sacrificing nothing to give you the best product available. You will find Stability™ to be a quality product beyond compare. There are many variations to consider, please call and let us help you find the perfect prescription for your office.

MAXILLARY		RX	TRQ	ROT	M/D	R/L	.018	.022
	SINGLE CONVERTIBLE BUCCAL TUBE	Roth	-10	8	3.5mm	UR6	#600-007	#600-107
		Roth	-10	8	3.5mm	UL6	#600-008	#600-108
		-	-10	0	3.5mm	UR6	#700-007	#700-107
		-	-10	0	3.5mm	UL6	#700-008	#700-108
		-	-10	12	3.5mm	UR6	#800-007	#800-107
		-	-10	12	3.5mm	UL6	#800-008	#800-108
	OCCLUSAL .045 HG CONV. BUCCAL TUBE	MBT	-10	8	3.5mm	UR6	#600-001	#600-101
		MBT	-10	8	3.5mm	UL6	#600-002	#600-102
	GINGIVAL .045 HG CONV. BUCCAL TUBE	ROTH	-10	8	3.5mm	UR6	#600-003	#600-103
		ROTH	-10	8	3.5mm	UL6	#600-004	#600-104
	1ST/2ND MOLAR NON-CONVERTIBLE BUCCAL TUBE	Roth	-10	8	3.5mm	UR6/7	#600-013	#600-113
		Roth	-10	8	3.5mm	UL6/7	#600-014	#600-114
		Standard	0	0	3.5mm	UR6/7	#700-013	#700-113
		Standard	0	0	3.5mm	UL6/7	#700-014	#700-114
		MBT	-14	10	3.5mm	UR6/7	#800-013	#800-113
		MBT	-14	10	3.5mm	UL6/7	#800-014	#800-114

buccal tubes



DynaFlex® Autoclavable Bite Stick

Brighten your office with these colorful bite sticks! Bite sticks are autoclavable up to 260 degrees or cold sterilizable.

#1426-05







DynaFlex® Heavy Duty Band Pusher

Manufactured of high quality surgical Stainless Steel, this instrument offers quality and durability and provides a firm grip allowing for superior control when seating bands of all types.

#1420

Stability™

Mandibular Buccal Tubes - Weldable

MANDIBULAR		RX	TRQ	ROT	M/D	R/L	.018	.022
	SINGLE CONVERTIBLE BUCCAL TUBE	Roth	-25	5	3.5mm	LR6	#600-021	#600-121
		Roth	-25	5	3.5mm	LL6	#600-022	#600-122
		MBT	-20	0	3.5mm	LR6	#700-021	#700-121
		MBT	-20	0	3.5mm	LL6	#700-022	#700-122
		-	-25	12	3.5mm	LR6	#800-021	#800-121
		-	-25	12	3.5mm	LL6	#800-022	#800-122
	.018 UTILITY ARCH SLOT CONVERTIBLE BUCCAL TUBE	Roth	-25	5	3.5mm	LR6	#600-023	#600-123
		Roth	-25	5	3.5mm	LL6	#600-024	#600-124
		MBT	-20	0	3.5mm	LR6	#700-023	#700-123
		MBT	-20	0	3.5mm	LL6	#700-024	#700-124
	GINGIVAL HEADGEAR/ LIP BUMPER CONVERTIBLE BUCCAL TUBE	Roth	-25	5	3.5mm	LR6	#600-028	#600-128
		Roth	-25	5	3.5mm	LL6	#600-029	#600-129
	1ST/2ND MOLAR NON-CONVERTIBLE BUCCAL TUBE	Roth	-25	5	3.5mm	LR6/7	#600-031	#600-131
		Roth	-25	5	3.5mm	LL6/7	#600-032	#600-132
		-	-10	0	3.5mm	LR6/7	#700-031	#700-131
		-	-10	0	3.5mm	LL6/7	#700-032	#700-132
		Standard	0	0	3.5mm	LR6/7	#800-031	#800-131
		Standard	0	0	3.5mm	LL6/7	#800-032	#800-132

DynaFlex® Convertible Cap Remover

For use in removing the convertible cap on a convertible molar bracket when necessary.

#1610



GEMINI™



Low Profile Buccal Tubes - Bondable

GEMINI™ Stainless Steel Buccal Tubes feature a low profile, comfortable hooks, and an anatomical design maximizing patient comfort. Additional features include a larger wire opening, torque in base, color coding for each quadrant, buccal indent for ideal fit and 80-gauge mesh base for unsurpassed retention.

Gemini™ Non-Convertible - 10 Pack

Mini

MAXILLARY	TRQ	ROT	M/D	R/L	.018	.022
MBT	-14	+10	3.8mm	UL	#M-GMT816UL	#M-GMT216UL
MBT	-14	+10	3.8mm	UR	#M-GMT816UR	#M-GMT216UR
Roth	-9	+7	3.8mm	UL	#M-GMT806UL	#M-GMT206UL
Roth	-9	+7	3.8mm	UR	#M-GMT806UR	#M-GMT206UR
Standard	0	+6	3.8mm	UL6/LR6	#M-GMT8SUL6/LR6	#M-GMT2SUL6/LR6
Standard	0	+6	3.8mm	UR6/LL6	#M-GMT8SUR6/LL6	M-GMT2SUR6/LL6
MANDIBULAR	TRQ	ROT	M/D	R/L	.018	.022
MBT	-20	0	3.8mm	LL	#M-GMT816LL	#M-GMT216LL
MBT	-20	0	3.8mm	LR	#M-GMT816LR	#M-GMT216LR
Roth	-30	+7	3.8mm	LL	#M-GMT806LL	#M-GMT206LL
Roth	-30	+7	3.8mm	LR	#M-GMT806LR	#M-GMT206LR

Micro

MAXILLARY	TRQ	ROT	M/D	R/L	.018	.022
MBT	-14	+10	3.5mm	UL	#M-GMT817UL	#M-GMT217UL
MBT	-14	+10	3.5mm	UR	#M-GMT817UR	#M-GMT217UR
Roth	-9	+6	3.5mm	UL	#M-GMT807UL	#M-GMT207UL
Roth	-9	+6	3.5mm	UR	#M-GMT807UR	#M-GMT207UR
Standard	0	+6	3.5mm	UL7/LR7	#M-GMT8SUL7/LR7	#M-GMT2SUL7/LR7
Standard	0	+6	3.5mm	UR7/LL7	#M-GMT8SUR7/LL7	#M-GMT2SUR7/LL7
MANDIBULAR	TRQ	ROT	M/D	R/L	.018	.022
MBT	-10	0	3.5mm	LL	#M-GMT817LL	#M-GMT217LL
MBT	-10	0	3.5mm	LR	#M-GMT817LR	#M-GMT217LR
Roth	-30	+6	3.5mm	LL	#M-GMT807LL	#M-GMT207LL
Roth	-30	+6	3.5mm	LR	#M-GMT807LR	#M-GMT207LR

Gemini™ Convertible - 10 Pack

Mini

MAXILLARY	TRQ	ROT	M/D	R/L	.018	.022
MBT	-14	+10	3.8mm	UL	#M-GMT813UL	#M-GMT213UL
MBT	-14	+10	3.8mm	UR	#M-GMT813UR	#M-GMT213UR
Roth	-9	+7	3.8mm	UL	#M-GMT803UL	#M-GMT203UL
Roth	-9	+7	3.8mm	UR	#M-GMT803UR	#M-GMT203UR
MANDIBULAR	TRQ	ROT	M/D	R/L	.018	.022
MBT	-20	0	3.8mm	LL	#M-GMT813LL	#M-GMT213LL
MBT	-20	0	3.8mm	LR	#M-GMT813LR	#M-GMT213LR
Roth	-30	+7	3.8mm	LL	#M-GMT803LL	#M-GMT203LL
Roth	-30	+7	3.8mm	LR	#M-GMT803LR	#M-GMT203LR

Gemini™ Double-Convertible - 10 Pack

Mini

MAXILLARY	TRQ	ROT	M/D	R/L	.022
Roth	-9	+7	3.8mm	UL	#M-GMT203DUL
Roth	-9	+7	3.8mm	UR	#M-GMT203DUR
MANDIBULAR	TRQ	ROT	M/D	R/L	.022
Roth	-28	+7	3.8mm	LL	#M-GMT203DLL
Roth	-28	+7	3.8mm	LR	#M-GMT203DLR



DynaFlex® Posterior Bracket Tweezer - Small

Similar to our standard bracket tweezer but with smaller, angulated beaks allowing for more visibility when placing brackets. Reverse-action provides for ease in loading and firm grip. Overall length is 4 1/2".

#1417



DynaFlex® Buccal Tube Instrument

Don't miss out on the convenience of this product! This instrument makes placing molar brackets much easier than ever before! The instrument has a very slender tip that inserts easily into the slot on the molar bracket. The reverse-action tweezer allows for precise and easy placement of the molar bracket.

#1400-676

WIRES & AUXILIARIES



PACKAGING OPTIONS:

- 10 Singles Per Pack
- Pack of 10
- Pack of 25
- Bulk Pack (100 Pack)



Archwire Force Load Chart

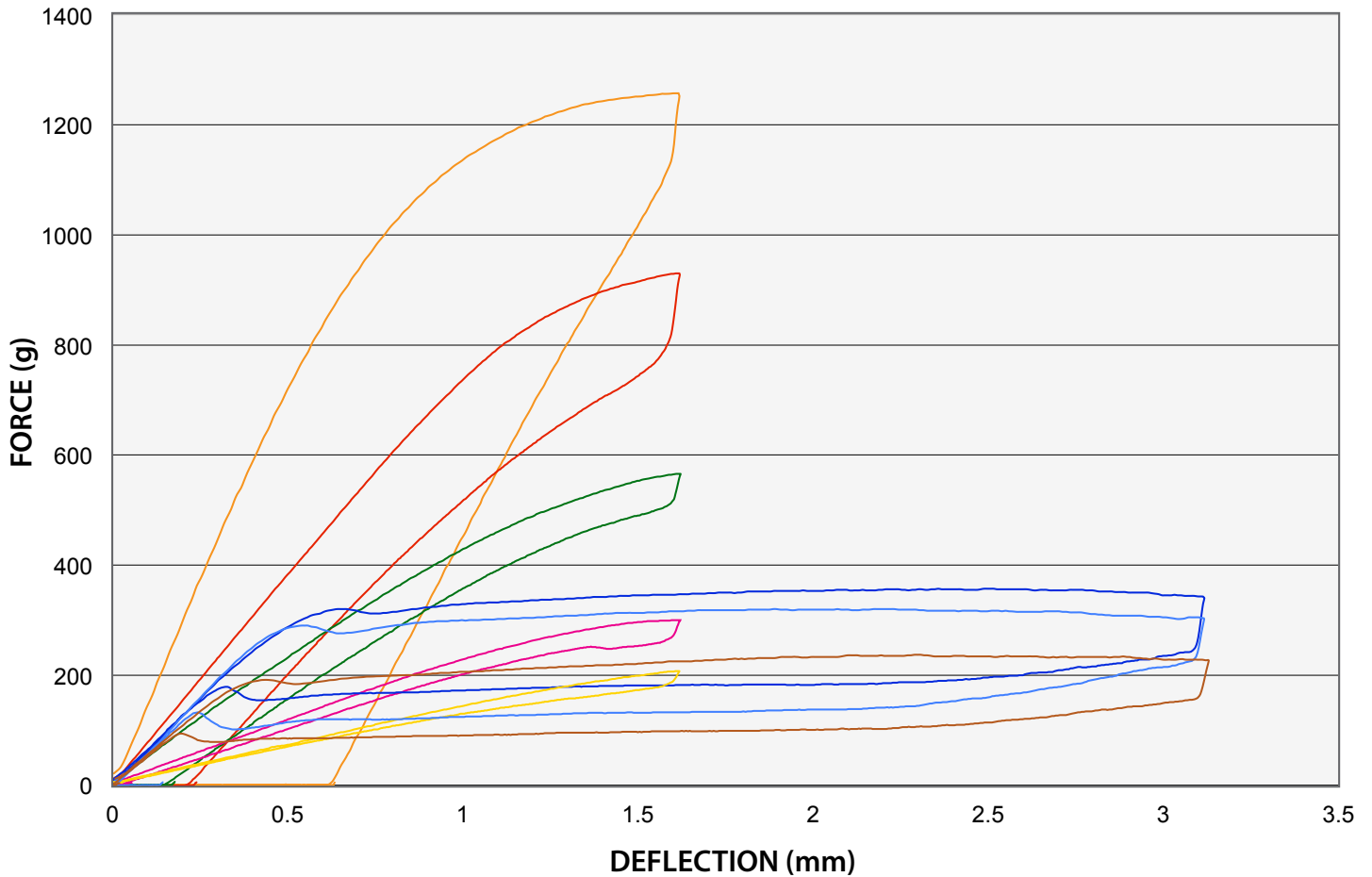

Material Comparison Single Cycle - 10 mm span

Archwire Types:

- Stainless Steel
- 3-Strand Stainless Steel
- DynaTi NiTi
- Dyna-Therm® Plus
- CNA®
- Coax Stainless Steel
- 8-Braid Stainless Steel
- Copper NiTi

**We Manufacture
The Most Accurate
High Quality
Archwires
In The Industry...**

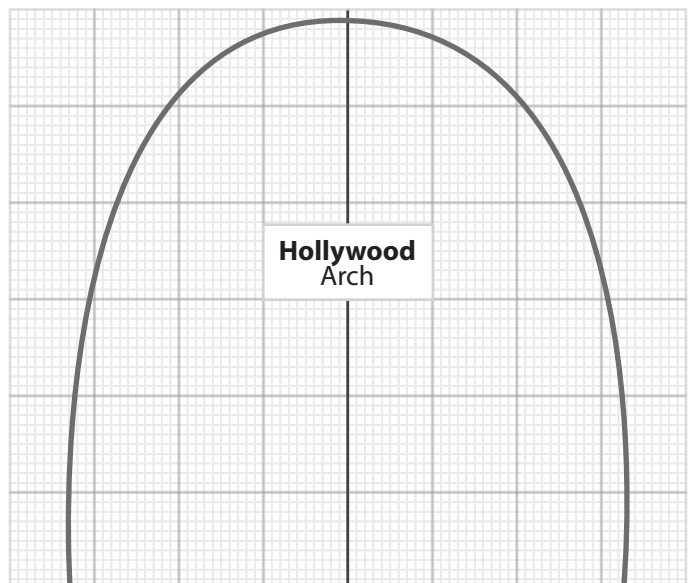
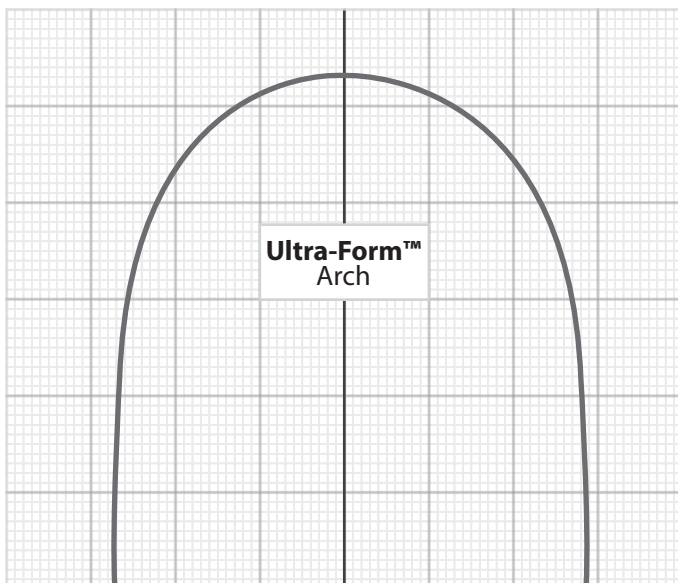
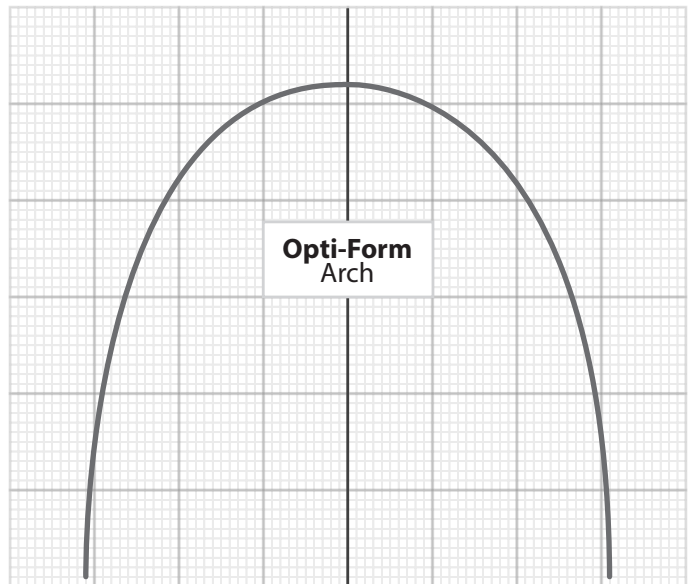
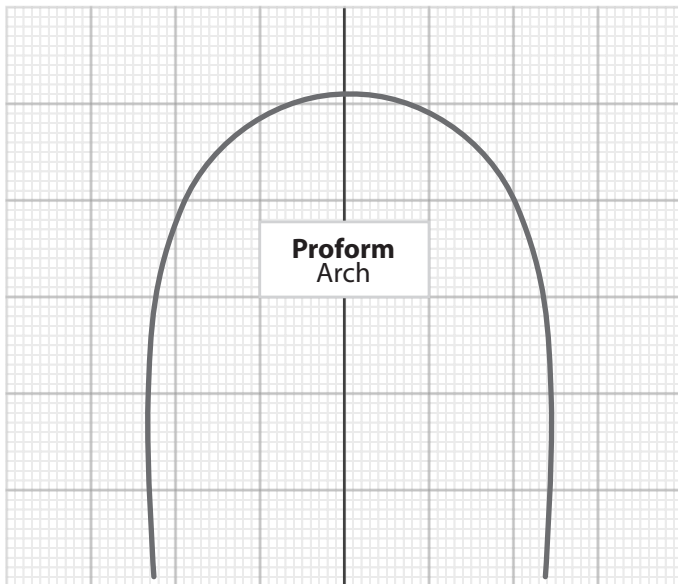
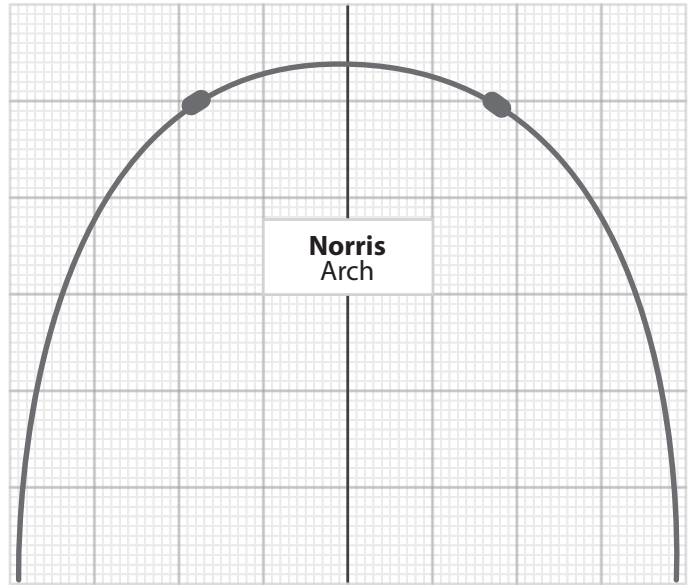

Norris **EXTRA BROAD** ARCHWIRE



As with the Norris 20/26® Brackets, the Norris Extra Broad wires are a break from convention and take what we know about expanded arches and aesthetic expression to a whole new level. Once again, Dr. Robert "Tito" Norris learned from observation and trial and error, then synthesized what he experienced from the use of existing broad arch forms into the extra broad arch form we have now developed. A non-coordinated arch makes it possible to treat both the maxilla and mandible with the same form. Thirty percent broader than the broadest arch on the market, this extra broad arch achieves a number of key efficiencies and effects: it affords maximum space as it expresses each tooth to its full outer- most potential; it gains maximum leveling and alignment as the teeth are afforded a greater range of motion; it influences the musculature of the surrounding soft tissue earlier in preparation for subsequent desired reprogramming; and it introduces a collaborative dynamic sooner between the bracket and the wire.

Throughout the later working and finishing stages of treatment, a "Rounded" Rectangular (19x25) arch wire is introduced (yet another DynaFlex® exclusive) that makes insertion, clip closure, and seating smoother than ever. Norris Extra Broad Wires are the perfect complement in how they fully express the torque and tip of the bracket over existing passive systems, yet without the binding of other higher frictional systems. Most importantly, however, is how they both fit to produce broader, more expressive smiles than anything else available today.

The Norris Extra Broad Archwires are 30% broader than the broadest arch on the market. This extra broad arch achieves a number of key efficiencies and effects:

- **Maximum Leveling & Alignment**
Teeth are afforded a greater range of motion.
- **Treating Posterior Cross Bite**
The broad shaped archwire can often be effective at correcting crossbites.
- **Produces A Beautiful Broad Smile**
Reduces The Dark Posterior Buccal Corridors and expresses each tooth to its full outer- most potential.
- **Pre-Stopped**
This helps control wire shifting archwire and can be tightened at any position along the arch in accordance with the doctor's preference.
- **19x25 "Rounded Rectangular"**
This "Rounded-Rectangular" NiTi, Beta and Stainless Steel archwire shape makes insertion, clip closure, and seating smoother than ever. Only the sharp corners are rounded so torque control is not compromised.

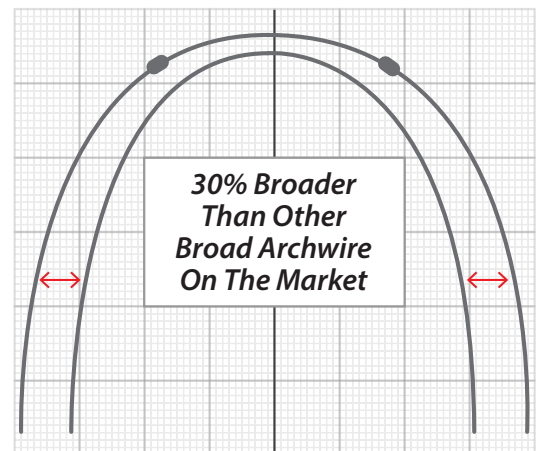

**Norris
"Double-Take"
Mouth Mirror
Page 137.**

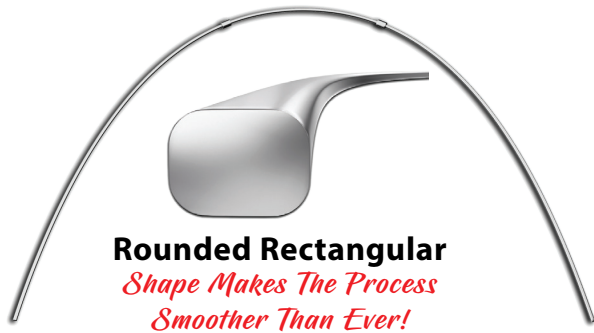

ROUNDED RECTANGULAR

Control Without Compromise

Makes insertion, clip closure, and seating smoother than ever. Only the sharp corners are rounded so torque control is not compromised.

ARCHWIRE SEQUENCING GUIDE

PHASE	INITIAL ALIGNMENT	WORKING ALIGNMENT	WORKING FINISHING I	WORKING FINISHING II
WIRE	.014 NiTi	.018 x .018" NiTi	.019 x .025" Rounded NiTi	.019 x .025" Rounded Beta
DURATION	10 Weeks	10 Weeks	10 Weeks	8 Weeks Or Until Finished

ITEM #	NORRIS EXTRA BROAD ARCHWIRE 10 PACK
#09-216-200	Norris Extra Broad Archwire, Round, .014 Niti
#09-216-300	Norris Extra Broad Archwire, Round, .016 Niti
#09-216-400	Norris Extra Broad Archwire, Round, .018 Niti
#09-226-100	Norris Extra Broad Archwire, Rectangular, .014 X .025 Niti
#09-226-200	Norris Extra Broad Archwire, Rectangular, .016 X .016 Niti
#09-226-300	Norris Extra Broad Archwire, Rectangular, .016 X .022 Niti
#09-226-350	Norris Extra Broad Archwire, Rectangular, .016 X .025 Niti
#09-226-500	Norris Extra Broad Archwire, Rectangular, .017 X .025 Niti
#09-226-550	Norris Extra Broad Archwire, Rectangular, .018 X .018 Niti
#09-226-600	Norris Extra Broad Archwire, Rectangular, .018 X .025 Niti
#09-226-800	Norris Extra Broad Archwire, Rectangular, .020 X .020 Niti
#09-326-500	Norris Extra Broad Archwire, Rectangular, .017 X .025 Beta
#09-326-700	Norris Extra Broad Archwire, Rounded Rect., .019 X .025 Beta
#09-426-700	Norris Extra Broad Archwire, Rounded Rect., .019 X .025 Niti
#09-500-100	Norris Extra Broad Archwire, Rounded Rect., .019 X .025 Stainless Steel
ITEM #	NORRIS UNIVERSAL ARCHWIRE 10 PACK
#09-5014-100	Norris Universal Archwire, .014 Niti
#09-51425-100	Norris Universal Archwire, .014 X .025 Niti
#09-51818-100	Norris Universal Archwire, .018 X .018 Niti
#09-51925-100	Norris Universal Archwire, Rounded Rect., .019 X .025 Niti
#09-61925-500	Norris Universal Archwire, Rounded Rect., .019 X .025 Beta

Dyna Ti Nickel Titanium Archwires

Super Elastic Nickel Titanium

Only the highest-grade raw material will meet our standards for manufacturing! We say, "Start with the best, end with the best!" Our Super Elastic Nickel Titanium outperforms all others while leaving plenty of money in your pocket! Extremely long working range and ultra smooth finish will produce guaranteed results every time!



Proform - 10 Singles/Pack		
SIZE	UPPER	LOWER
.012	#0910AU-500	#0910AL-500
.014	#0910BU-500	#0910BL-500
.016	#0910CU-500	#0910CL-500
.018	#0910DU-500	#0910DL-500
.020	#0910EU-500	#0910EL-500
ROUND:		
.016 x .016	#0911AU-500	#0911AL-500
.016 x .022	#0911BU-500	#0911BL-500
.017 x .025	#0911CU-500	#0911CL-500
.018 x .025	#0911EU-500	#0911EL-500
.019 x .025	#0911FU-500	#0911FL-500
RECTANGULAR:		

Proform - 10 Pack		
SIZE	UPPER	LOWER
.012	#0910-AU	#0910-AL
.014	#0910-BU	#0910-BL
.016	#0910-CU	#0910-CL
.018	#0910-DU	#0910-DL
.020	#0910-EU	#0910-EL
ROUND:		
.016 x .016	#0911-AU	#0911-AL
.016 x .022	#0911-BU	#0911-BL
.017 x .025	#0911-CU	#0911-CL
.018 x .025	#0911-EU	#0911-EL
.019 x .025	#0911-FU	#0911-FL
.021 x .025	#0911-GU	#0911-GL
RECTANGULAR:		

Proform Bulk - 100 Pack		
SIZE	UPPER	LOWER
.012	#095-001U	#095-001L
.014	#095-002U	#095-002L
.016	#095-003U	#095-003L
.018	#095-004U	#095-004L
.020	#095-005U	#095-005L
ROUND:		
.016 x .016	#097-001U	#097-001L
.016 x .022	#097-002U	#097-002L
.017 x .025	#097-003U	#097-003L
.018 x .025	#097-004U	#097-004L
.019 x .025	#097-005U	#097-005L
.021 x .025	#097-006U	#097-006L
RECTANGULAR:		

Ultra-Form™ - 10 Pack		
SIZE	UPPER	LOWER
.012	#0927-AU	#0927-AL
.014	#0927-BU	#0927-BL
.016	#0927-CU	#0927-CL
.018	#0927-DU	#0927-DL
.020	#0927-EU	#0927-EL
ROUND: \$24.50/pk.		
.016 x .016	#0928-AU	#0928-AL
.016 x .022	#0928-BU	#0928-BL
.017 x .025	#0928-CU	#0928-CL
.018 x .025	#0928-DU	#0928-DL
.019 x .025	#0928-EU	#0928-EL
RECTANGULAR:		

Opti-Form - 10 Pack	
SIZE	UNIVERSAL
.012	#0980-AU
.013	#0980-BU
.014	#0980-CU
.016	#0980-DU
.018	#0980-EU
ROUND: \$24.50/pk.	
.014 x .025	#0981-AU
.016 x .016	#0981-BU
.017 x .025	#0981-CU
.018 x .025	#0981-DU
.019 x .025	#0981-EU
RECTANGULAR:	

DynaFlex® Dynalce Spray

Turns Niti soft instantly. Chill spray makes working with and adjusting Niti memory wire and expanders much easier. Chills to -62°F. Nonflammable aerosol spray is convenient and just a quick spray is all that's needed. 10 oz.



#0913

DynaTherm Plus™

Heat Activated Alloy Technology

DynaTherm Plus™ is designed to have superior resiliency and withstand the most demanding clinical applications with seriously misaligned teeth. DynaTherm Plus™ is a TRUE Thermal archwire; soft at room temperature and active at 90° Fahrenheit.

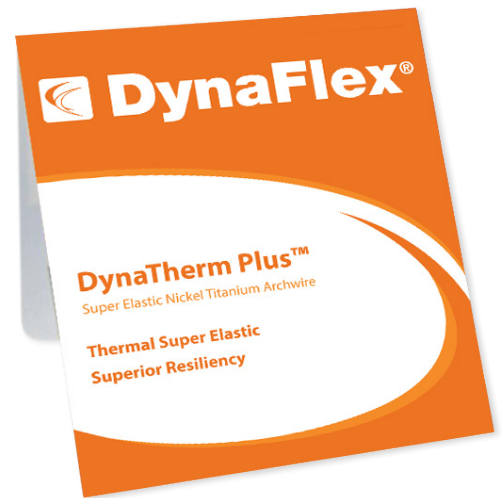

Tinius Olsen Load Chart

Based on .250 in. lb. Load and 1/4" span (@100°F)

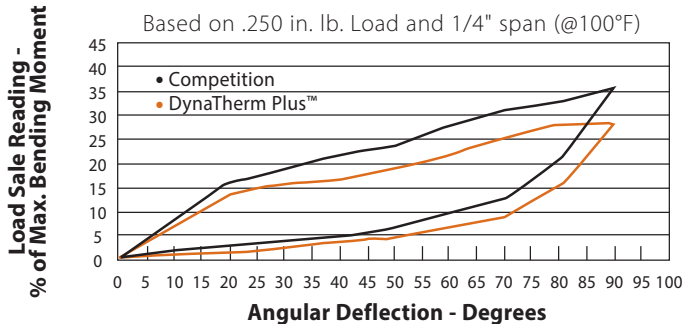

Proform - 10 Singles/Pack		
SIZE	UPPER	LOWER
.012	#0944EU-500	#0944EL-500
.014	#0944AU-500	#0944AL-500
.016	#0944BU-500	#0944BL-500
.018	#0944CU-500	#0944CL-500
.020	#0944DU-500	#0944DL-500
ROUND:		
.016 x .016	#0945AU-500	#0945AL-500
.016 x .022	#0945BU-500	#0945BL-500
.017 x .025	#0945CU-500	#0945CL-500
.018 x .025	#0945DU-500	#0945DL-500
.019 x .025	#0945EU-500	#0945EL-500
RECTANGULAR:		

Proform - 10 Pack		
SIZE	UPPER	LOWER
.012	#0944-EU	#0944-EL
.014	#0944-AU	#0944-AL
.016	#0944-BU	#0944-BL
.018	#0944-CU	#0944-CL
.020	#0944-DU	#0944-DL
ROUND:		
.016 x .016	#0945-AU	#0945-AL
.016 x .022	#0945-BU	#0945-BL
.017 x .025	#0945-CU	#0945-CL
.018 x .025	#0945-DU	#0945-DL
.019 x .025	#0945-EU	#0945-EL
.021 x .025	#0945-FU	#0945-FL
RECTANGULAR:		

Ultra-Form™ - 10 Pack		
SIZE	UPPER	LOWER
.012	#0947-EU	#0947-EL
.014	#0947-AU	#0947-AL
.016	#0947-BU	#0947-BL
.018	#0947-CU	#0947-CL
.020	#0947-DU	#0947-DL
ROUND:		
.016 x .016	#0948-AU	#0948-AL
.016 x .022	#0948-BU	#0948-BL
.017 x .025	#0948-CU	#0948-CL
.018 x .025	#0948-DU	#0948-DL
.019 x .025	#0948-EU	#0948-EL
.021 x .025	#0948-FU	#0948-FL
RECTANGULAR:		

Opti-Form - 10 Singles/Pack	
SIZE	UNIVERSAL
.013	#0949AU-500
.014	#0949BU-500
.016	#0949CU-500
.018	#0949DU-500
ROUND:	
.014 x .025	#0950AU-500
.016 x .016	#0950BU-500
.016 x .025	#0950CU-500
.017 x .025	#0950DU-500
.018 x .025	#0950EU-500
.019 x .025	#0950FU-500
RECTANGULAR:	

Opti-Form - 10 Pack	
SIZE	UNIVERSAL
.013	#0949-AU
.014	#0949-BU
.016	#0949-CU
.018	#0949-DU
ROUND:	
.014 x .025	#0950-AU
.016 x .016	#0950-BU
.016 x .025	#0950-CU
.017 x .025	#0950-DU
.018 x .025	#0950-EU
.019 x .025	#0950-FU
RECTANGULAR:	

- Low forces for greater patient comfort
- Lighter forces for easier ligation in difficult cases
- Improved resiliency to permanent deformation
- Ideal for patients with significant crowding
- Ability to place heavier wires in earlier
- Compare to Copper NiTi™ 35°C and GAC Sentalloy
- DynaTherm Plus wire delivers 200gm of force

CNA™ Archwire

Beta Titanium Alloy - The Alternative To TMA™

We went a step beyond TMA™. CNA™ improves bending characteristics and has a smoother surface to improve the sliding mechanics. This is the optimum nickel free alloy that takes intricate bends and is about as half as stiff as stainless steel. Available in proform shape with extended ends for extra detailing. Pack of 10.

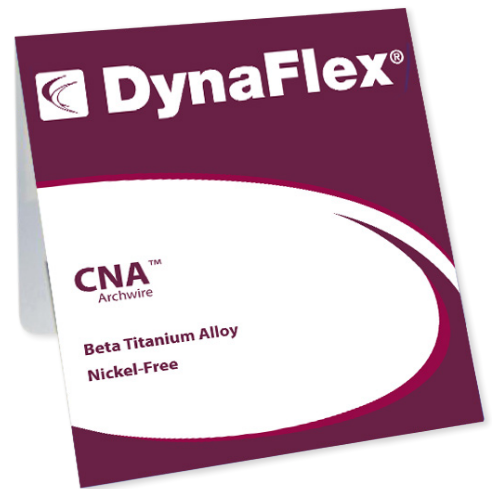

- Nickel - Free
- Low force - deflection rate
- Weldable
- Low modules of elasticity.
- Can be deflected 100% more than stainless steel without permanent deformation.
- Constant forces over longer period of time.
- Compare to TMA™

Proform - 10 Pack		
SIZE	UPPER	LOWER
.016	#0963-BU	#0963-BL
.018	#0963-CU	#0963-CL
ROUND:		
.016 x .022	#0961-AU	#0961-AL
.017 x .025	#0961-BU	#0961-BL
.018 x .025	#0961-DU	#0961-DL
.019 x .025	#0961-CU	#0961-CL
RECTANGULAR:		

Opti-Form - 10 Pack	
SIZE	UNIVERSAL
.016 x .022	#0964-AU
.016 x .025	#0964-BU
.017 x .025	#0964-CU
.018 x .025	#0964-DU
.019 x .025	#0964-EU
RECTANGULAR:	

Force Charts

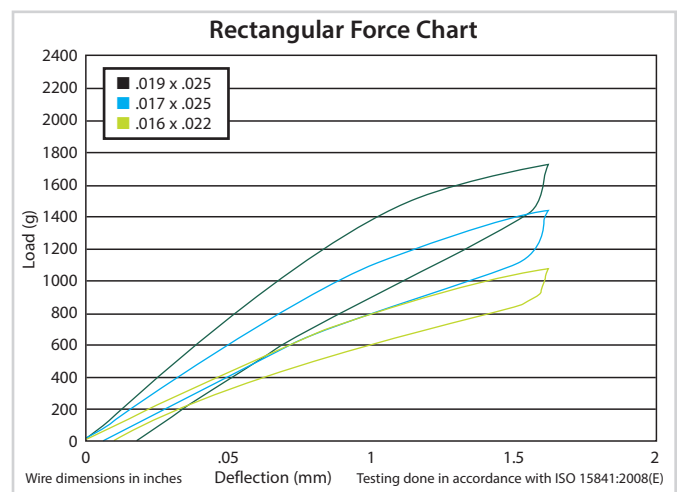
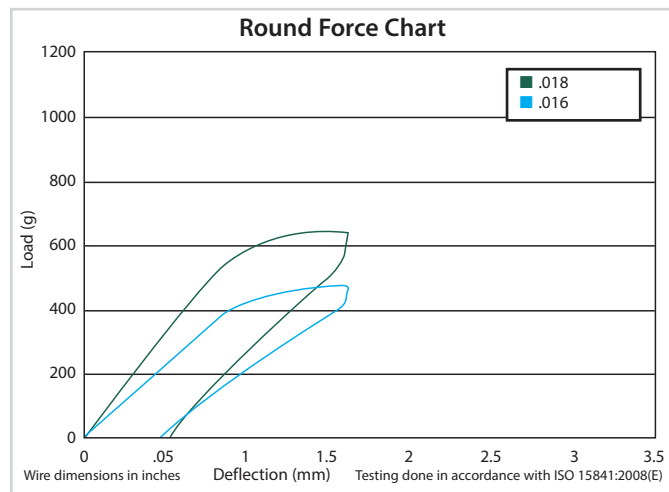

Copper NiTi

Ensures True Activation

Introducing a Copper NiTi wire that exceeds clinical expectations and surpasses other copper archwire. Our Copper NiTi has extremely good control over tooth moving loads and superior balance of force levels. With a silky smooth finish and very gentle loading for early engagement, this wire will exceed all your expectations. Pack of 10.



Incredible Results!

Proform 27°C - 10 Pack		
SIZE	UPPER	LOWER
.013	#10-C27013U	#10-C27013L
.014	#10-C27014U	#10-C27014L
.016	#10-C27016U	#10-C27016L
.018	#10-C27018U	#10-C27018L
ROUND:		
.014 x .025	#10-C27014025U	#10-C27014025L
.016 x .025	#10-C27016025U	#10-C27016025L
.017 x .025	#10-C27017025U	#10-C27017025L
.018 x .025	#10-C27018025U	#10-C27018025L
.019 x .025	#10-C27019025U	#10-C27019025L
RECTANGULAR:		

Proform 35°C - 10 Pack		
SIZE	UPPER	LOWER
.016	#10-C35016U	#10-C35016L
.018	#10-C35018U	#10-C35018L
ROUND:		
.016 x .022	#10-C35016022U	#10-C35016022L
.017 x .025	#10-C35017025U	#10-C35017025L
.018 x .025	#10-C35018025U	#10-C35018025L
.019 x .025	#10-C35019025U	#10-C35019025L
RECTANGULAR:		

Opti-Form 27°C - 10 Pack	
SIZE	UNIVERSAL
.013	#09-C27013
.014	#09-C27014
.016	#09-C27016
.018	#09-C27018
ROUND:	
.014 x .025	#09-C27014025
.016 x .025	#09-C27016025
.017 x .025	#09-C27017025
.018 x .025	#09-C27018025
.019 x .025	#09-C27019025
RECTANGULAR:	

Opti-Form 35°C - 10 Pack	
SIZE	UNIVERSAL
.016	#09-C35016
.018	#09-C35018
ROUND:	
.017 x .025	#09-C35017025
.018 x .025	#09-C35018025
.019 x .025	#09-C35019025
RECTANGULAR:	

Bioflex3[®]

Heat Activated, Multi-Force Nickel Titanium

- Three distinct force regions in one archwire.
- Heat activated, multi-force Nickel Titanium wire.
- Ideal biological forces for efficient tooth movement.
- Reduce the number and frequency of wire changes.
- Almost half the price of comparable wires.
- Compare to GAC BioForce[®].
- Pack of 10.

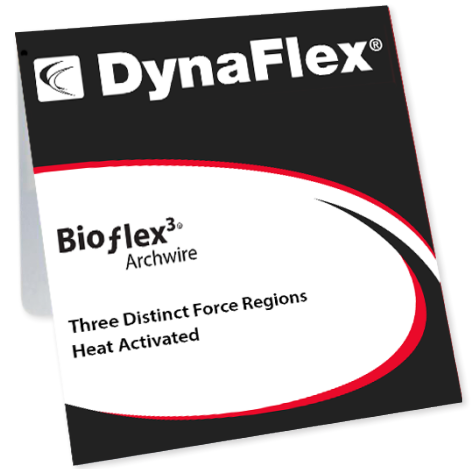

Proform - 10 Pack		
SIZE	UPPER	LOWER
.016	#0931-GU	#0931-GL
.018	#0931-HU	#0931-HL
ROUND:		
.016 x .016	#0931-AU	#0931-AL
.016 x .022	#0931-BU	#0931-BL
.017 x .025	#0931-JU	#0931-JL
.018 x .018	#0931-CU	#0931-CL
.018 x .025	#0931-DU	#0931-DL
.019 x .025	#0931-EU	#0931-EL
.020 x .020	#0931-FU	#0931-FL
RECTANGULAR:		

Three Distinct Force Regions

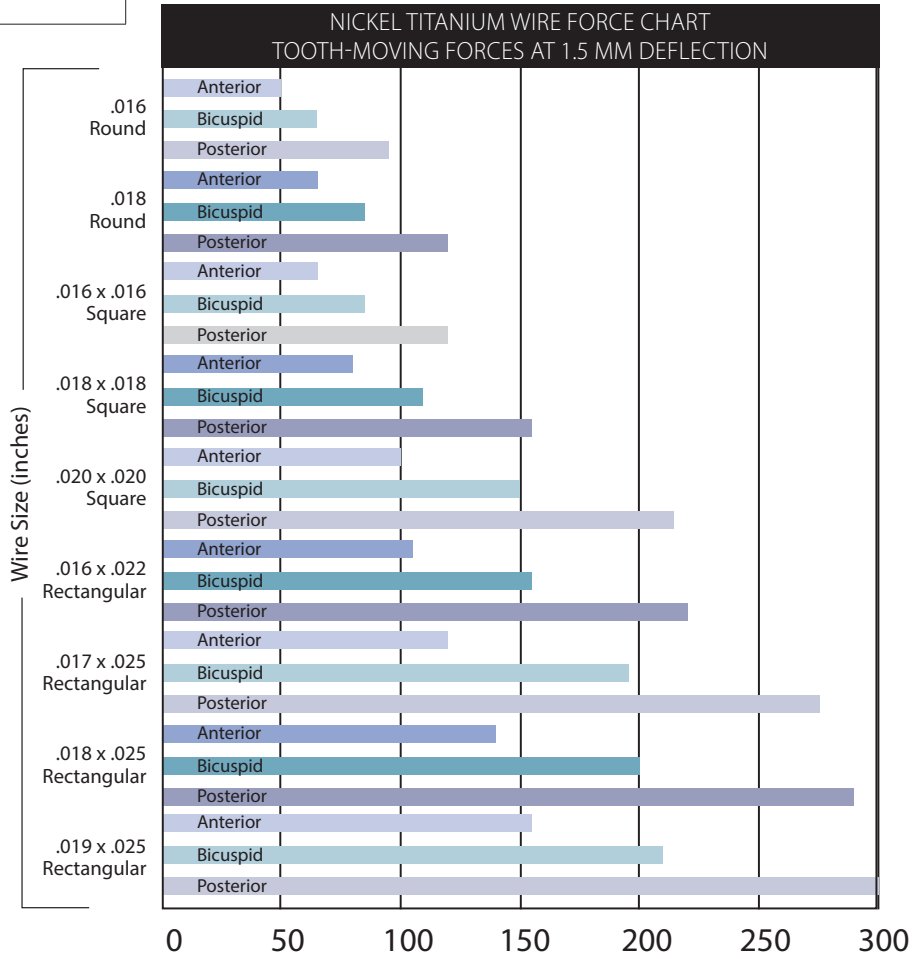
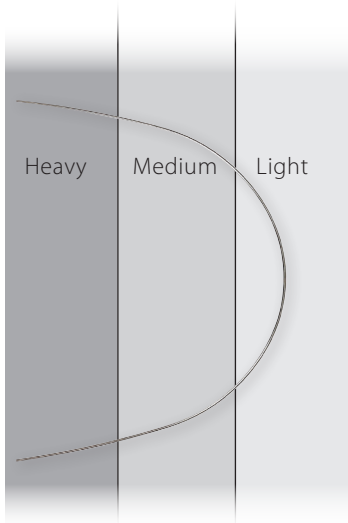

GAC Bioforce[®] archwire is a registered trademark of GAC Dentsply[®].

3-Point Bend Test performed on a 10mm wire span.

Wire tested in the Buccal-Lingual plane to allow for curvature of the archwire.

DynaTorque™ Archwires

Ideal For Passive, Self-Ligating Bracket Systems

DynaTorque™ is a full-sized NiTi archwires with the anterior section pre-torqued to 20°. This specialized, preformed wire allows for the addition of torque into the anterior region while maintaining non-torque in the posterior region.

- Provides 20° anterior torque without bending.
- Early introduction of torque in upper centrals and laterals.
- Provides uprighting torque in the lower anterior segment.
- Labial or lingual torque forces by reversing wire orientation.
- Ideal for passive, self-ligating bracket systems.
- Pack of 10.

Proform 34mm - 10 Pack	
SIZE	UPPER
.016 x .022	#0971-AU
.017 x .025	#0971-BU
.018 x .025	#0971-CU
.019 x .025	#0971-DU
.021 x .025	#0971-EU
RECTANGULAR:	

Proform 38mm - 10 Pack	
SIZE	UPPER
.016 x .022	#0972-AU
.017 x .025	#0972-BU
.018 x .025	#0972-CU
.019 x .025	#0972-DU
.021 x .025	#0972-EU
RECTANGULAR:	

Proform 28mm - 10 Pack	
SIZE	LOWER
.016 x .022	#0970-AL
.017 x .025	#0970-BL
.018 x .025	#0970-CL
.019 x .025	#0970-DL
.021 x .025	#0970-EL
RECTANGULAR:	

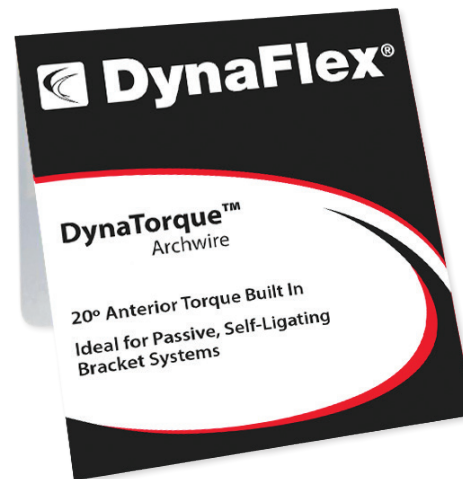

20° Anterior Torque Bend



Stainless Steel Archwires

Superior Quality

As always, all of our archwires are polished to a high luster and feature a silky smooth finish to reduce friction. Our superior quality double spring temper stainless steel archwires are a preferred and economical choice for your office.



archwires

Proform - 10 Singles/Pack		
SIZE	UPPER	LOWER
.012	#0900AU-500	#0900AL-500
.014	#0900BU-500	#0900BL-500
.016	#0900CU-500	#0900CL-500
.018	#0900DU-500	#0900DL-500
.020	#0900EU-500	#0900EL-500
ROUND:		
.016x.016	#0902AU-500	#0902AL-500
.016x.022	#0902BU-500	#0902BL-500
.017x.025	#0902CU-500	#0902CL-500
.018x.025	#0902DU-500	#0902DL-500
.019x.025	#0902EU-500	#0902EL-500
RECTANGULAR:		

Proform - 10 Pack		
SIZE	UPPER	LOWER
.012	#0900-AU	#0900-AL
.014	#0900-BU	#0900-BL
.016	#0900-CU	#0900-CL
.018	#0900-DU	#0900-DL
.020	#0900-EU	#0900-EL
ROUND:		
.016 x .016	#0902-AU	#0902-AL
.016 x .022	#0902-BU	#0902-BL
.017 x .025	#0902-CU	#0902-CL
.018 x .025	#0902-DU	#0902-DL
.019 x .025	#0902-EU	#0902-EL
.021 x .025	#0902-FU	#0902-FL
RECTANGULAR:		

Proform - Bulk 100 Pack		
SIZE	UPPER	LOWER
.012	#100-001U	#100-001L
.014	#100-002U	#100-002L
.016	#100-003U	#100-003L
.018	#100-004U	#100-004L
.020	#100-005U	#100-005L
ROUND:		

Proform - Bulk 50 Pack		
SIZE	UPPER	LOWER
.016x.016	#102-001U	#102-001L
.016x.022	#102-002U	#102-002L
.017x.025	#102-003U	#102-003L
.018x.025	#102-004U	#102-004L
.019x.025	#102-005U	#102-005L
.021x.025	#102-006U	#102-006L
RECTANGULAR:		

Opti-Form - 10 Singles/Pack	
SIZE	UPPER
.012	#0976AU-500
.014	#0976BU-500
.016	#0976CU-500
.018	#0976DU-500
ROUND:	
.016x.022	#0977AU-500
.016x.025	#0977BU-500
.017x.025	#0977CU-500
.018x.025	#0977DU-500
.019x.025	#0977EU-500
RECTANGULAR:	

Opti-Form - 10 Pack	
SIZE	UPPER
.012	#0976-AU
.014	#0976-BU
.016	#0976-CU
.018	#0976-DU
ROUND:	
.016 x .022	#0977-AU
.016 x .025	#0977-BU
.017 x .025	#0977-CU
.018 x .025	#0977-DU
.019 x .025	#0977-EU
RECTANGULAR:	

Ultra-Form™ - 10 Pack		
SIZE	UPPER	LOWER
.012	#0924-AU	#0924-AL
.014	#0924-BU	#0924-BL
.016	#0924-CU	#0924-CL
.018	#0924-DU	#0924-DL
.020	#0924-EU	#0924-EL
ROUND:		
.016 x .016	#0925-AU	#0925-AL
.016 x .022	#0925-BU	#0925-BL
.017 x .025	#0925-CU	#0925-CL
.018 x .025	#0925-DU	#0925-DL
.019 x .025	#0925-EU	#0925-EL
RECTANGULAR:		

HOLLYWOOD Archwire



Developed By:
Dr. Michael Williams, DDS

Creating Beautiful, Perfect Smiles

Why choose the Hollywood Archwire?

Written by Dr. Michael Williams

Hollywood Arches have been designed to develop the bicuspid area and to deliver bicuspid prominence, creating a beautiful Hollywood smile! These archwires have the broadest archform transversely in the bicuspid area. What does this archform deliver? It eliminates the triangular dark corridors in your patient's smile.

Originally designed for use with the Series 2000 appliances and for those doctors looking to get fuller expression from self-ligating bracket systems. When using these archwire after the Series 2000 appliances, you will notice these archwires will maintain the dimension gained by the appliances and allow you to develop the dental and facial aesthetics to a whole new level!

Recent modifications extended the length of archwire allowing helical and other types of closed loop configurations to be made easily. The additional archwire length also allows for the wire to reach into the second molar bracket with cinch back activation.

Hollywood - 10 Pack	
SIZE	UNIVERSAL
.016 x .016	#0919U-1616
.016 x .022	#0919U-1622
.018 x .018	#0919U-1818
.018 x .025	#0919U-1825
RECTANGULAR:	



Stainless steel, universal archwire for perfecting your patient's smile!

For That Wide Hollywood Smile!

BEFORE

AFTER

DynaFlex® now has the perfect, broadest archform to create those Hollywood smiles everyone dreams about!

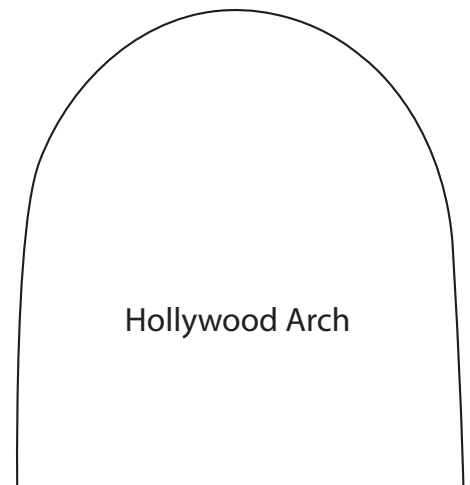

Coated Archwire

Tooth colored wire has all the same great features as our Select wire but with a durable plastic tooth-colored overcoat. Choose NiTi (Proform or Opti-Form) or Colored S.S (Proform). 25 per pack.

- Superior aesthetics
- Stain resistance
- Low friction
- NiTi 25 per pack
- S.S Colored 25 per pack

NiTi Coated Proform - 25 Pack		
SIZE	UPPER	LOWER
.014	#M-NDWC014U	#M-NDWC014L
.016	#M-NDWC016U	#M-NDWC016L
.018	#M-NDWC018U	#M-NDWC018L
.020	#M-NDWC020U	#M-NDWC020L
ROUND:		
.014X.025	#M-NDWC1425U	#M-NDWC1425L
.016X.016	#M-NDWC1616U	#M-NDWC1616L
.016X.022	#M-NDWC1622U	#M-NDWC1622L
.017X.025	#M-NDWC1725U	#M-NDWC1725L
.018X.025	#M-NDWC1825U	#M-NDWC1825L
.019X.025	#M-NDWC1925U	#M-NDWC1925L
.020X.020	#M-NDWC2020U	#M-NDWC2020L
.021X.025	#M-NDWC2125U	#M-NDWC2125L
RECTANGULAR:		



White Colored S.S - 25 Pack		
SIZE	UPPER	LOWER
.012	#M-SWC012U 25PK	#M-SWC012L 25PK
.014	#M-SWC014U 25PK	#M-SWC014L 25PK
.016	#M-SWC016U 25PK	#M-SWC016L 25PK
.018	#M-SWC018U 25PK	#M-SWC018L 25PK
.020	#M-SWC020U 25PK	#M-SWC020L 25PK
ROUND:		
.016X.016	#M-SWC1616U 25PK	#M-SWC1616L 25PK
.016X.022	#M-SWC1622U 25PK	#M-SWC1622L 25PK
.017X.025	#M-SWC1725U 25PK	#M-SWC1725L 25PK
.018X.018	#M-SWC1818U 25PK	#M-SWC1818L 25PK
.018X.025	#M-SWC1825U 25PK	#M-SWC1825L 25PK
.019X.025	#M-SWC1925U 25PK	#M-SWC1925L 25PK
.020X.020	#M-SWC2020U 25PK	#M-SWC2020L 25PK
.021X.025	#M-SWC2125U 25PK	#M-SWC2125L 25PK
RECTANGULAR:		

NiTi Coated - 25 Pack		
SIZE	UPPER	LOWER
.012	#M-NWC012U	#M-NWC012L
.014	#M-NWC014U	#M-NWC014L
.016	#M-NWC016U	#M-NWC016L
.018	#M-NWC018U	#M-NWC018L
.020	#M-NWC020U	#M-NWC020L
ROUND:		
.016X.016	#M-NWC1616U	#M-NWC1616L
.016X.022	#M-NWC1622U	#M-NWC1622L
.017X.025	#M-NWC1725U	#M-NWC1725L
.018X.018	#M-NWC1818U	#M-NWC1818L
.018X.025	#M-NWC1825U	#M-NWC1825L
.019X.025	#M-NWC1925U	#M-NWC1925L
.020X.020	#M-NWC2020U	#M-NWC2020L
.021X.025	#M-NWC2125U	#M-NWC2125L
RECTANGULAR:		

Size shown is finished size. White coating adds .002" thickness to diameter.

Gold Plated Archwire

Available in Stainless Steel or Nickel Titanium

Go for the complete look of Gold with our Gold Plated Stainless Steel and Niti Archwire. To provide you the best available archwire in gold, we have gold plated our Proform Stainless Steel and Niti Archwire. Same great quality of wires with a plating that will not flake or discolor. **Pack of 5.**

Now in 5 packs!



Be **Bold With Gold**, Patient's Love These!

Proform Stainless Steel - 5 Pack		
.014	#0900G-BU	#0900G-BL
.016	#0900G-CU	#0900G-CL
.018	#0900G-DU	#0900G-DL
ROUND:		
.016x.016	#0902G-AU	#0902G-AL
.016x.022	#0902G-BU	#0902G-BL
.018x.025	#0902G-DU	#0902G-DL
.019x.025	#0902G-EU	#0902G-EL
RECTANGULAR:		

Proform Nickel Titanium - 5 Pack		
.012	#0910G-AU	#0910G-AL
.014	#0910G-BU	#0910G-BL
.016	#0910G-CU	#0910G-CL
.018	#0910G-DU	#0910G-DL
ROUND:		
.016x.016	#0911G-AU	#0911G-AL
.016x.022	#0911G-BU	#0911G-BL
.018x.025	#0911G-DU	#0911G-DL
.019x.025	#0911G-EU	#0911G-EL
RECTANGULAR:		

DynaFlex® Dyna Ti Reverse Curve II Nickel Titanium Archwires

Our new Reverse Curve II – Nickel Titanium wire is now available. Using a slight curve with virtually no toe-in action at the molars. This wire is just what you have been waiting for! Pack of 10.

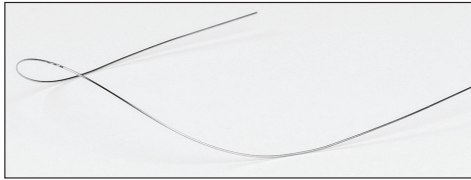

Round		
SIZE	UPPER	LOWER
.012	#0932-AU	#0932-AL
.014	#0932-BU	#0932-BL
.016	#0932-CU	#0932-CL
.018	#0932-DU	#0932-DL
.020	#0932-EU	#0932-EL

Rectangular		
SIZE	UPPER	LOWER
.016 x .016	#0933-AU	#0933-AL
.016 x .022	#0933-BU	#0933-BL
.017 x .025	#0933-CU	#0933-CL
.018 x .025	#0933-DU	#0933-DL
.019 x .025	#0933-EU	#0933-EL
.021 x .025	#0933-FU	#0933-FL

DynaFlex® Dimple Nickel Titanium

Dimple in archwire provides a permanent mid-line mark. Eliminates midline shifting. Reduces patient discomfort. Pack of 10.

Round - 10 Pack		
SIZE	UPPER	LOWER
.014	#0934-AU	#0934-AL
.016	#0934-BU	#0934-BL
.018	#0934-CU	#0934-CL
.020	#0934-DU	#0934-DL

Round - Bulk 100 Pack		
SIZE	UPPER	LOWER
.012	#M-NCDP012UB	#M-NCDP012LB
.014	#M-NCDP014UB	#M-NCDP014LB
.016	#M-NCDP016UB	#M-NCDP016LB
.018	#M-NCDP018UB	#M-NCDP018LB
.020	#M-NCDP020UB	#M-NCDP020LB

Rectangular - Bulk 100 Pack		
SIZE	UPPER	LOWER
.016 x .022	#M-NCDP1622UB	#M-NCDP1622LB
.017 x .025	#M-NCDP1725UB	#M-NCDP1725LB
.019 x .025	#M-NCDP1925UB	#M-NCDP1925LB
.021 x .025	#M-NCDP2125UB	#M-NCDP2125LB

Rectangular - 10 Pack		
SIZE	UPPER	LOWER
.016 x .016	#0935-AU	#0935-AL
.016 x .022	#0935-BU	#0935-BL
.017 x .025	#0935-CU	#0935-CL
.018 x .025	#0935-EU	#0935-EL
.019 x .025	#0935-FU	#0935-FL
.021 x .025	#0935-GU	#0935-GL



DynaFlex® U Marc™ Markers

A favorite for many of our customers! Our Markers are great for marking archwires, retainers, headgear and facebows. The blue plastic handle is octagon shaped for easier handling, even when wearing gloves. Choose from orange or white. Pack of 100.

ITEM #	DESCRIPTION
#1373	Orange Markers
#1374	White Markers

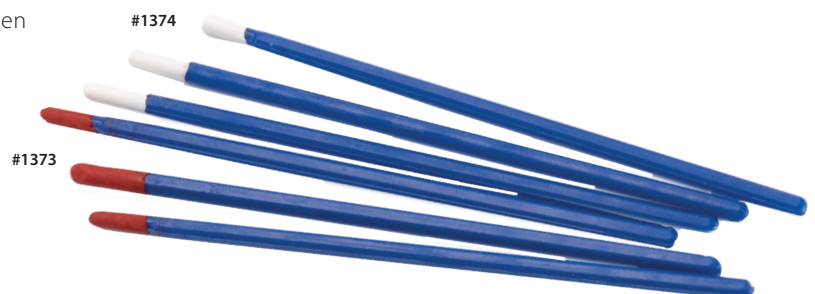

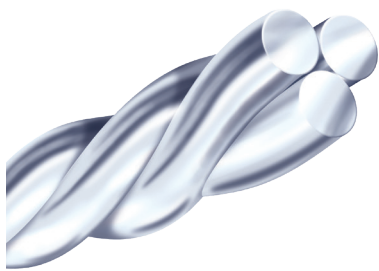

DynaFlex® 3-Strand Twist Archwire

Our superior quality 3 strand wire delivers a light force with good flexibility and spring back. DynaFlex® 3 strand will not unravel when cut. Great for initial treatment. Pack of 10.

Proform - Round - 10 Pack

SIZE	UPPER	LOWER
.0155	#0920-AU	#0920-AL
.0175	#0920-BU	#0920-BL
.0195	#0920-CU	#0920-CL
.0215	#0920-DU	#0920-DL

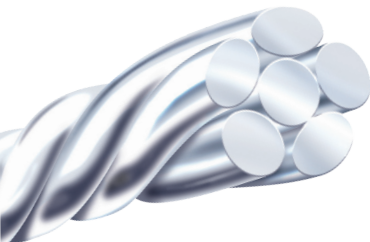

DynaFlex® 6-Strand Coaxial Archwire

Excellent for initial leveling and aligning when teeth are severely misaligned. Great flexibility and super smooth silky finish means less resistance and lower friction when engaged in bracket slot! Pack of 10.

Proform Shape - 10 Pack

SIZE	UPPER	LOWER
.0155	#0958-001	#0958-011
.0175	#0958-002	#0958-012
.0195	#0958-003	#0958-013
.0215	#0958-004	#0958-014

14" LENGTHS

#O-952-7200
#O-952-7202
#O-952-7204
#O-952-7206

30' SPOOLS

#O-952-7100
#O-952-7102
#O-952-7104
#O-952-7106

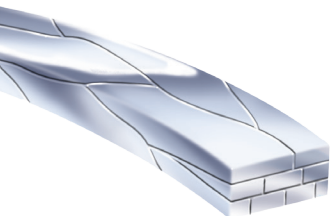

DynaFlex® 8-Braid Archwire

Extremely flexible wire means torque control in leveling phase of treatment. Will not fray when cut. Superior resiliency for initial and finishing stages. Pack of 10.

Proform Shape

SIZE	UPPER	LOWER
.016 x .016	#0959-001	#0959-011
.016 x .022	#0959-002	#0959-012
.017 x .025	#0959-003	#0959-013
.018 x .025	#0959-005	#0959-015
.019 x .025	#0959-006	#0959-016

DynaFlex® 14" Straight Lengths - Stainless Steel

Economical wire excellent for laboratory use or spring formation. Available in round and rectangular. Pack of 10.

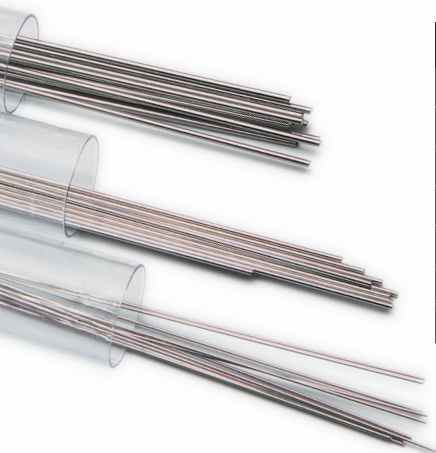

Round

SIZE	ITEM #	SIZE	ITEM #
.012	#0950-012	.030	#0950-030
.014	#0950-014	.032	#0950-032
.016	#0950-016	.036	#0950-036
.018	#0950-018	.040	#0950-040
.020	#0950-020	.045	#0950-045
.028	#0950-028	.056	#0950-056

Rectangular

SIZE	ITEM #
.016 x .016	#0951-016
.016 x .022	#0951-022
.017 x .025	#0951-017
.018 x .025	#0951-018
.019 x .025	#0951-019
.021 x .025	#0951-021

DynaFlex® Straight Lengths & Spools: Nickel Titanium Archwire

- Great for custom arches & sectionals
- Super Elastic & Super Smooth
- Economical to use & easy to store

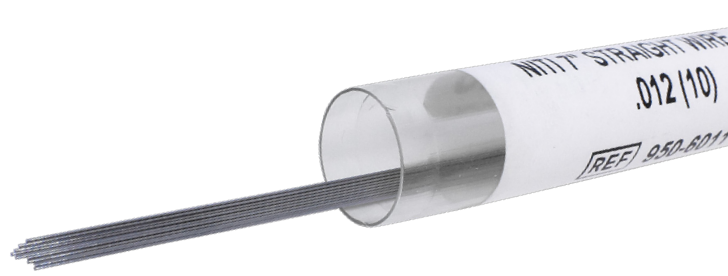

(10) 7" Straight Lengths

SIZES	ITEM #	SIZES	ITEM #
.012	#O-950-6011	.018	#O-950-6014
.014	#O-950-6012	.020	#O-950-6015
.016	#O-950-6013		

Round
Pack of 10

(10) 7" Straight Lengths

SIZES	ITEM #	SIZES	ITEM #
.016 x .016	#O-950-6020	.018 x .025	#O-950-6026
.016 x .022	#O-950-6021	.019 x .025	#O-950-6027
.017 x .025	#O-950-6023	.021 x .025	#O-950-6029
.018 x .018	#O-950-6024		

Rectangle
Pack of 10

15" Spool

SIZES	ITEM #
.012	#O-950-6001
.014	#O-950-6002
.016	#O-950-6003

15" Spools

DynaFlex® Titanium Molybdenum Archwires

- Half the force of stainless steel
- Twice the working range of stainless steel
- Excellent flexibility and spring back
- Pack of 10

High Quality Archwire

Natural Form

ITEM NUMBER	UPPER	ITEM NUMBER	LOWER
#O-950-1300	.016 x .022	#O-950-1301	.016 x .022
#O-950-1304	.017 x .025	#O-950-1305	.017 x .025
#O-950-1308	.019 x .025	#O-950-1309	.019 x .025

SL Arch

ITEM NUMBER	SIZE
#O-950-1340	.017 x .025
#O-950-1344	.019 x .025

*The SL Universal Arch
Shape is perfect for
Self-Ligating Brackets*

Euro Arch

ITEM NUMBER	UPPER	ITEM NUMBER	LOWER
#O-950-1320	.016 x .022	#O-950-1321	.016 x .022
#O-950-1324	.017 x .025	#O-950-1325	.017 x .025
#O-950-1328	.019 x .025	#O-950-1329	.019 x .025

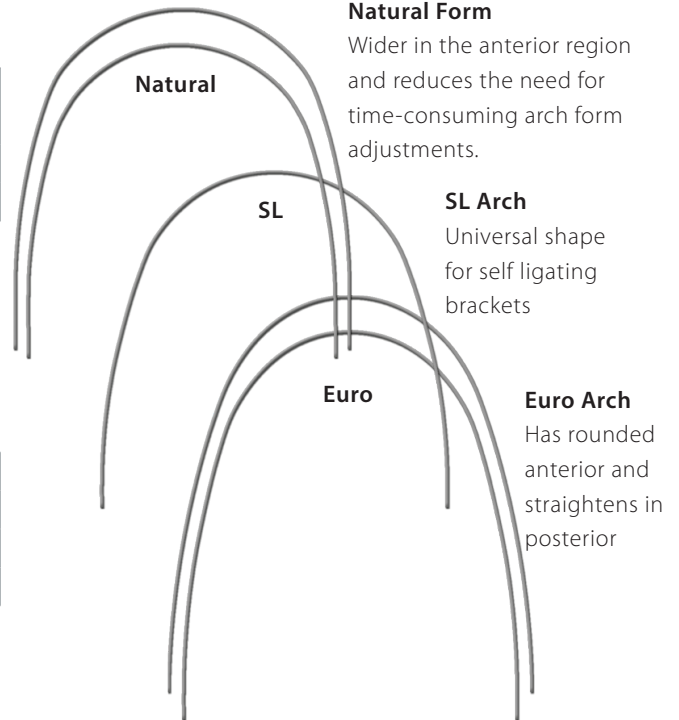

Natural Form

Wider in the anterior region and reduces the need for time-consuming arch form adjustments.

SL Arch

Universal shape for self ligating brackets

Euro Arch

Has rounded anterior and straightens in posterior

DynaFlex® Archwire Dispensers

Keep your office neat and organized with our covered archwire dispensers! Two styles to suit your office needs!

#1493-01 Holds 12 different wires

#1493 Holds 10 different wires



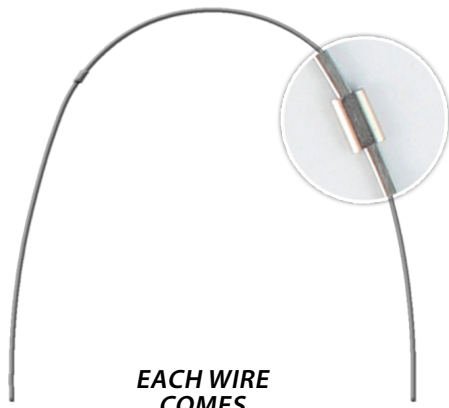

**EACH WIRE
COMES
INDIVIDUALLY
WRAPPED**

DynaFlex® Copper Niti With Stops: For Self-Ligating Brackets

- Excellent springback provides fast and efficient tooth movement
- Easy engagement in slot due to smaller loading forces than standard Nickel Titanium
- Even at small deflections still provides continuous force
- Resistant to permanent deformation
- Precise temperature range means predictable results
- Very easy to engage
- Pack of 10

Round

SIZE	ITEM NUMBER
.014	#O-950-1140
.016	#O-950-1142
.018	#O-950-1144

Rectangular

SIZE	ITEM NUMBER
.014 x .025	#O-950-1160
.016 x .025	#O-950-1162
.018 x .018	#O-950-1164
.018 x .025	#O-950-1166
.019 x .025	#O-950-1168

DynaFlex® Pre-Stopped Nickel Titanium Archwire: Pre-Installed Tube Stops

Two crimpable tube stops are pre-loaded and lightly crimped on archwires to provide the clinician with easy positioning along the arch. With only a light crimp, the tube stops are secured in place.

- Tube stops help to control wire movement along the arch.
- Convenient alternate to cinching
- Two bright, fully annealed 304SS 2mm long stops pre-crimped per archwire
- Small tubes (ID of .019") are pre-installed on round wires.
- Large tubes (ID of .031") are pre-installed on square and rectangle wires
- Pack of 10

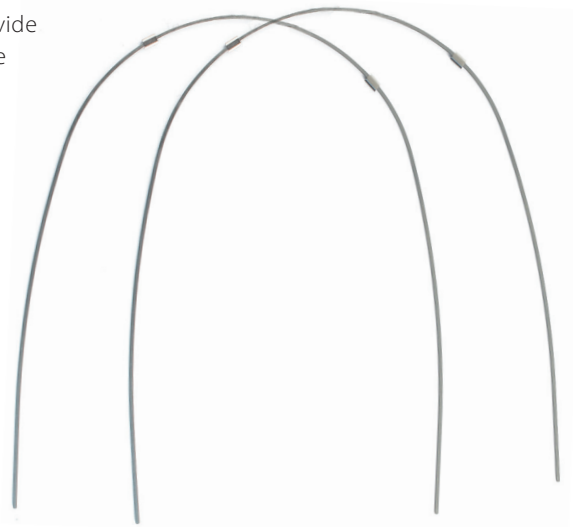

SIZES	ITEM NUMBER
.012	#O-950-4042
.014	#O-950-4044
.016	#O-950-4046
.018	#O-950-4048

Round

SIZES	ITEM NUMBER	SIZES	ITEM NUMBER
.014 x .025	#O-950-4052	.018 x .018	#O-950-4062
.016 x .016	#O-950-4054	.018 x .025	#O-950-4064
.016 x .022	#O-950-4056	.019 x .025	#O-950-4066
.016 x .025	#O-950-4058	.020 x .020	#O-950-4068
.017 x .025	#O-950-4060		

Rectangular

DynaFlex® Nickel-Free Beta III CNA: Mushroom Looped Archwire

- Biomechanically-designed loops
- Consistent force
- Larger activations

Pack of 10

UPPER SIZE	.016 x .022	.017 x .025	.019 x .025
32 mm	#O-950-9030	#O-950-9031	#O-950-9032
34 mm	#O-950-9033	#O-950-9034	#O-950-9035
36 mm	#O-950-9036	#O-950-9037	#O-950-9038
38 mm	#O-950-9039	#O-950-9040	#O-950-9041
40 mm	#O-950-9042	#O-950-9043	#O-950-9044
42 mm	#O-950-9045	#O-950-9046	#O-950-9047
46 mm	#O-950-9048	#O-950-9049	#O-950-9050



Pack of 10

LOWER SIZE	.016 x .022	.017 x .025	.019 x .025
24 mm	#O-950-9060	#O-950-9061	#O-950-9062
26 mm	#O-950-9063	#O-950-9064	#O-950-9065
28 mm	#O-950-9066	#O-950-9067	#O-950-9068
30 mm	#O-950-9069	#O-950-9070	#O-950-9071

DynaFlex® Stainless Steel: Keyhole Looped Archwire

Available in 2 and 4 loop options, these archwires will ensure accurate placement every time. Made from medical grade 304V stainless steel these wires feature bright, smooth, flat surfaces. The consistent shape will ensure your patients of great results every time. Used in sliding mechanics for extraction space closure and also in non-extraction Class II cases. Commonly used in combination with elastics or closed coil springs. Biocompatible, able to place and hold intricate bends, consistent force, and superior tensile strength. Packs of 10.

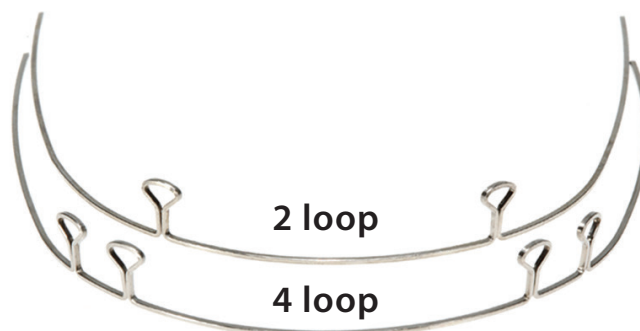

2 Loop

UPPER SIZE	.016 X .022	.017 X .025	.019 X .025
34 mm	#O-951-8001	#O-951-8002	#O-951-8003
36 mm	#O-951-8005	#O-951-8006	#O-951-8007
38 mm	#O-951-8009	#O-951-8010	#O-951-8011
40 mm	#O-951-8013	#O-951-8014	#O-951-8015
42 mm	#O-951-8017	#O-951-8018	#O-951-8019
44 mm	#O-951-8021	#O-951-8022	#O-951-8023

4 Loop

UPPER SIZE	.016 X .022	.017 X .025	.019 X .025	.021 X .025
34 mm	#O-951-8049	#O-951-8050	#O-951-8051	#O-951-8052
36 mm	#O-951-8053	#O-951-8054	#O-951-8055	#O-951-8056
38 mm	#O-951-8057	#O-951-8058	#O-951-8059	#O-951-8060
40 mm	#O-951-8061	#O-951-8062	#O-951-8063	#O-951-8064
42 mm	#O-951-8065	#O-951-8066	#O-951-8067	#O-951-8068
44 mm	#O-951-8069	#O-951-8070	#O-951-8071	#O-951-8072

LOWER SIZE	.016 X .022	.017 X .025	.019 X .025
22 mm	#O-951-8025	#O-951-8026	#O-951-8027
24 mm	#O-951-8029	#O-951-8030	#O-951-8031
26 mm	#O-951-8033	#O-951-8034	#O-951-8035
28 mm	#O-951-8037	#O-951-8038	#O-951-8039
30 mm	#O-951-8041	#O-951-8042	#O-951-8043
32 mm	#O-951-8045	#O-951-8046	#O-951-8047

LOWER SIZE	.016 X .022	.017 X .025	.019 X .025	.021 X .025
22 mm	#O-951-8073	#O-951-8074	#O-951-8075	#O-951-8076
24 mm	#O-951-8077	#O-951-8078	#O-951-8079	#O-951-8080
26 mm	#O-951-8081	#O-951-8082	#O-951-8083	#O-951-8084
28 mm	#O-951-8085	#O-951-8086	#O-951-8087	#O-951-8088
30 mm	#O-951-8089	#O-951-8090	#O-951-8091	#O-951-8092
32 mm	#O-951-8093	#O-951-8094	#O-951-8095	#O-951-8096

DynaFlex® Stainless Steel Archwire - Bulk Pack Gold Tone

We've spared no time or expense in the development of our high quality stainless steel archwires. Using the latest manufacturing technology and the highest grade stainless steel wire available enables us to offer you a consistent quality product at a very competitive price. As with all our products, our stainless steel archwires are manufactured under the strictest quality standards and FDA guidelines.

- Guaranteed less than 3° torque on square and rectangular wires
- Super high-luster polish for reduced friction
- Made from high quality spring temper 304V stainless steel
- Midline marked with permanent etch centermark for complete patient protection

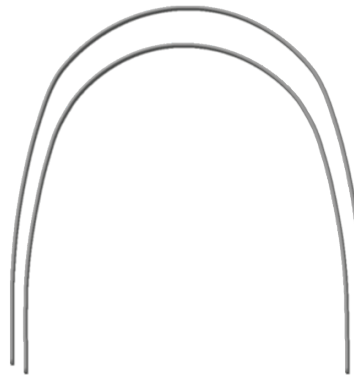

Natural Form

Wider in the anterior region and reduces the need for time-consuming arch form adjustments.

Natural Gold Tone - Round

SIZES	UPPER	LOWER
.012	#O-951-5001	#O-951-5002
.014	#O-951-5003	#O-951-5004
.016	#O-951-5005	#O-951-5006
.018	#O-951-5007	#O-951-5008
.020	#O-951-5009	#O-951-5010

Round Pack of 100

Natural Gold Tone - Rect.

SIZES	UPPER	LOWER
.016 x .016	#O-951-5015	#O-951-5016
.016 x .022	#O-951-5017	#O-951-5018
.017 x .022	#O-951-5019	#O-951-5020
.017 x .025	#O-951-5021	#O-951-5022
.018 x .018	#O-951-5023	#O-951-5024
.018 x .022	#O-951-5025	#O-951-5026
.018 x .025	#O-951-5027	#O-951-5028
.019 x .025	#O-951-5029	#O-951-5030
.020 x .020	#O-951-5031	#O-951-5032
.021 x .025	#O-951-5033	#O-951-5034

Rectangular Pack of 50

Need Help Placing Your Order?

Our highly trained and skilled Customer Care Team is here to assist you with any questions you may have.

Call **866-346-5665** or
Chat Live online at
www.dynaflex.com/order



DynaFlex® Crimpable Mini Stops

Keep archwires from sliding past any desired point with our new Crimpable Mini Stops. Mini Stops can be easily placed anywhere on the archwire. Due to their small size, they are extremely comfortable for patients. Low profile, which makes them aesthetically pleasing. Available in two sizes. Pack of 25.



#2019 Small .019
#2021 Large .030

DynaFlex® Crimpable Ball Hooks

These Crimpable Ball Hooks are easy to crimp onto the archwire, inside or outside the mouth. Creates a strong, non-sliding lock with the archwire and remains in place. Ball hook portion can be bent to allow for different treatment procedures. Fits round or rectangular wire up to size 018x025. Pack of 20.



#2018

DynaFlex® MIM Crimpable Stop

Sleek, smooth and easy to place. Our new MIM crimpable stop can be placed anywhere on an archwire to limit tooth movement or maintain position. Fits round wire or rectangular wires up to .021 x .025. Pack of 10.



#2030

DynaFlex® Direct Bond Eyelet

Our nickel-free direct bond eyelet is easily bonded on the buccal or lingual of any tooth. Base allows for superior bond strength. Pack of 10.



#2016

DynaFlex® Crimpable Stops

Easy to use. Simply place on archwire to limit tooth movement and maintain position. Fits round and rectangular wires up to .021x.025. Pack of 10.



#2020

DynaFlex® Crimpable Ball Hooks - Curved

A great alternative to posted archwires. Easily placed on all wire sizes up to .021x.025. Slotted base is .022 allowing for easy placement on the wire, either in or out of the mouth. Curved hooks aid in the application of elastics and extension springs. Pack of 10.



#2018-R Right Curved Hook

#2018-L Left Curved Hook

DynaFlex® Stop Locks & Wrench

Stop Locks continue to be a secure technique for archwire locking. The Stop Lock base is a .022 slot which slides easily over the archwire and is held firmly by the nut. Can help prevent the archwire from sliding out of the buccal tube or can be used for compression spring treatment. Pack of 5.



#2022 Stop Locks

#2022-W Stop Lock Wrench (sterilizable)

DynaFlex® Crimpable Stops: Non-Slip Design

Our patent-pending, non-slip design is about to change what you think about crimpable archwire stops. Once crimped, our Non-Slip Stops remain securely in place due to the patent-pending, treated surface! Crimpable split archwire stops are designed to work with any type or size of wire, from nickel titanium to stainless steel, .012" to .021" x .025". No longer will you have to maintain an inventory of several different size stops or waste valuable chair time deciding what size to use. Our non-slip stops are your solution to every situation when a crimpable stop is needed.

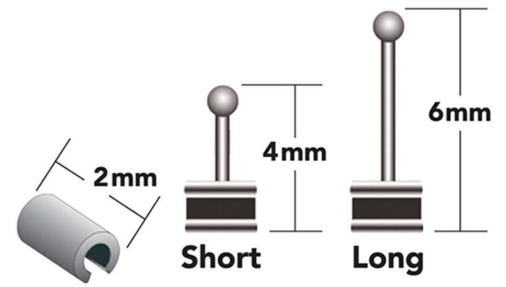

#O-160-1065 Etched Crimpable Stops Pack of 100

#O-160-1066 Etched Crimpable Hooks Long Pack of 20

#O-160-1067 Etched Crimpable Hooks Short Pack of 20

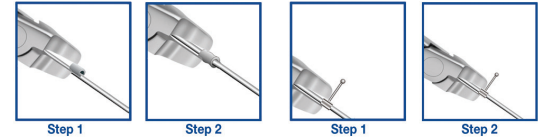

DynaFlex® Crimpable Stops

- Maintain wire positioning or limit tooth movement
- Fits round or rectangular archwire from .018 to .021 x .025
- Pack of 10



#O-160-1046

DynaFlex® Crimpable Hooks Stainless Steel

.012 x .025. Pack of 20.

#O-160-1056 Rights

#O-160-1057 Lefts



DynaFlex® Crimpable Ball Hooks

- Non-sliding, strong lock with archwire
- Ball hook can be bent left or right
- Fits round or rectangular archwire up to .018 x .025
- Pack of 10



#O-160-1044

DynaFlex® Crimpable Hooks Tooth Colored

Pack of 10.

#O-160-1058 Right

#O-160-1059 Left



DynaFlex® Vertical Slot Add-On Hooks

Compatible with popular Self Ligating brackets. Pack of 30.

#O-160-1055



DynaFlex® Sure Grip Stops

Sure Grip Stops are sandblasted for secure gripping power. Can be used anywhere on the archwire to limit tooth movement. 100 per pack (loose).



#M-SGSTOP 100 PK

DynaFlex® Shark Tooth Crimpable Ball Hook

Textured interior surface ensures a slide-proof lock. Works on all wires. Meticulously designed hook for patient comfort. Pack of 100.



#M-1020335204 Hook

#M-1020335205 Stop

DynaFlex® Nickel Titanium Open Coil Spring

Provides a gentle continuous force for easy opening of spaces.
Each pack contains three 7" pieces.



SIZE	ITEM #
.010 x .030	#1011-1
.012 x .030	#1011-2
.014 x .036	#1011-3
.010 x .045	#1011-4
.012 x .045	#1011-5

DynaFlex® Niti Open Coil Spring on Spool

Our .012 x .045 Nickel Titanium open coil spring is now available on a 15" spool.

#1018.

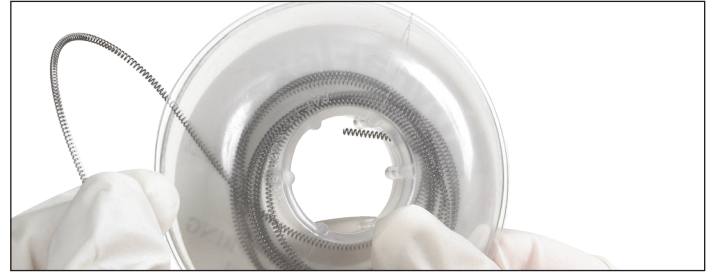

**HIGH
QUALITY
NICKEL
TITANIUM**



DynaFlex® Stainless Steel Open Coil Spring

High quality double spring temper stainless steel. Packed in convenient spools. 40" spool.

SIZE	ITEM #
.009 x .028	#1007-101
.009 x .030	#1007-102
.009 x .036	#1007-103
.010 x .028	#1008-101
.010 x .030	#1008-102
.010 x .036	#1008-103

DynaFlex® Stainless Steel Closed Coil Spring

Easy to use high quality stainless steel spring on a spool. Excellent rebound for retraction mechanics or just holding space. 40" per spool. .010 x .030.



#1007

DynaFlex® Nickel Titanium Closing Spring

Preformed springs with eye looped ends for bracket hooks or ligation. Niti Closing Spring. Pack of 10.



FORCE	LENGTH	ITEM #
200 GMS	9mm	#1010-H
150 GMS	9mm	#1010-M
100 GMS	9mm	#1010-L
100 GMS	12mm	#1012-L

DynaFlex® Open & Closed Coil Springs Bright Stainless Steel SL Springs: 40" Spool

Open Coil

.009 x .010 x .028ID #O-951-1202.
.009 x .010 x .030ID #O-951-1204
.009 x .010 x .036ID #O-951-1206

Open Coil



Closed Coil

.009 x .010 x .030ID #O-951-1208

Closed Coil



DynaFlex® Coated Niti Open Coil & Niti Closed Coil Spring

Coated Niti Open Coil allows for force and tooth movement as well as aesthetics! Also, now available, Coated Closed Coil! Aesthetically appealing.

- #1006-01 010x030 Open Coil (3-7" pieces/pack)
- #1006-02 010x036 Open Coil (3-7" pieces/pack)
- #1006-03 012x030 Open Coil (3-7" pieces/pack)
- #1006-04 012x032 Open Coil (3-7" pieces/pack)
- #1006-05 010x030 Closed Coil Spring (32" spool)



DynaFlex® Super Elastic Coil Springs Nickel Titanium



Compression: 15" Spool

- Force does not decay, fewer activations are required
- Delivers a light, constant force for more efficient tooth movement & patient comfort

SIZES	ITEM #
.010 x .030	#O-950-5120
.012 x .030	#O-950-5122
.012 x .045	#O-950-5124

Extension: Pack of 10

SIZES	ITEM #
.010 x .030 x 9mm	#O-950-5110
.010 x .030 x 12mm	#O-950-5112
.011 x .030 x 9mm	#O-950-5116



DynaFlex® Distalizing Coil Springs: Nickel Titanium

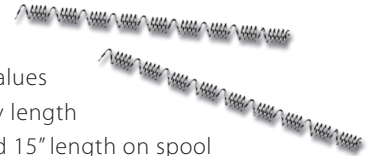

- Fits any size archwire
- Optimum super elastic force values
- Designed to "cut and fit" to any length
- .010 x .045 open/closed wound 15" length on spool

#O-950-5105 15" Spool .010x.045
#0972 3 x 7" Lengths

DynaFlex® Variable Force Coil Springs Nickel Titanium



- One spring design eliminates spring changes & reduces inventory
- Predictable, consistent forces for more efficient tooth movement

Compression: 15" Spool

SIZES	ITEM #	SIZES	ITEM #
.010 x .030	#O-950-5220	.010 x .045	#O-950-5226
.010 x .036	#O-950-5221	.011 x .030	#O-950-5228
.012 x .030	#O-950-5222	.012 x .040	#O-950-5230
.010 x .040	#O-950-5223	.014 x .030	#O-950-5232
.012 x .045	#O-950-5224	.014 x .036	#O-950-5234
.010 x .046	#O-950-5225	.014 x .045	#O-950-5236



Extension: Pack of 10

SIZES	ITEM #
.010 x .030 x 9mm	#O-950-5210
.010 x .030 x 12mm	#O-950-5212
.011 x .030 x 9mm	#O-950-5216

DynaFlex® S.S Coil Springs

Open and closed wound Stainless Steel wire designed to open and hold spaces. 3' per spool.

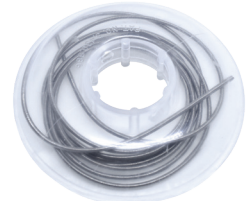

SIZE	CLOSED COIL	OPEN COIL
.010" x .030"	#M-SSCC1030	#M-SSCO1030
.010" x .036"	#M-SSCC1036	#M-SSCO1036

DynaFlex® NITI Open Coil Springs - Tooth Colored

- 7" Lengths (180mm)
- 2 Springs per pack
- .010" x .030" (.012" x .032" coated)
- Pack of 2

#O-951-1200

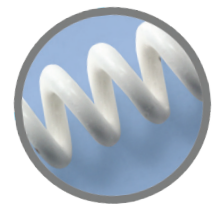

DynaFlex® Bracket Height Gauge: Sterilizable

Place your brackets at the correct height every time. Simply measure from the incisal edge.

- Plastic
- Aluminum
- Stainless Steel



SIZE	PLASTIC	ALUMINUM	S.S.
.018	#O-600-1004	#O-600-1006	#1433-05
.022	#O-600-1008	#O-600-1010	#1433

DynaFlex® 8 Braid Flat Dead Soft Stainless Steel

6" (Pack of 10)

#O-952-8250



DynaFlex® Multi-Strand Round Dead Soft Stainless Steel

7" (Pack of 10)

#O-952-8300 .0175

#O-952-8302 .0195



DynaFlex® Titanium Tri-Flex 6" (10 per tube)

- Nickel Free: Safe for patients with Nickel Sensitivity
- 3 strands enhance strength to avoid snapping & increase surface area
- Unique strand construction allows a slight degree of physiological movement yet retaining the post treatment smile arch

#O-952-8315

Dead Soft Wire For Bonded Lingual Retainers



DynaFlex® Molar Uprighting Springs

The new Molar Uprighting Spring is a tremendous solution to a common problem. By using a newly developed super elastic spring you can upright molars extremely effectively. You will also be able to intrude molars depending on the individual patient needs. Pack of 10.

Follow these simple steps for molar uprighting:

1. Place crosstube on archwire.
2. Make a bend in the steel section of the uprighting spring.
3. Place NITI part of uprighting spring into buccal tube.
4. Place steel part of uprighting spring into crosstube.
5. The light forces applied to the molars will allow the molar to upright in a consistent manner.

#101-1010

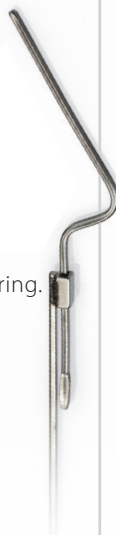

DynaFlex® De-Impactor Springs

An adjustable separating spring that uprights and erupts impacted molars and bicuspid in 4-6 weeks! Step-by-step illustrated instructions included. Regular or short size. Pack of 12.

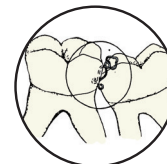
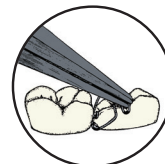

#1050 Regular Size

#1055 Short Size

DynaFlex® Cross Tubes

Use with molar uprighting spring. Pack of 10.

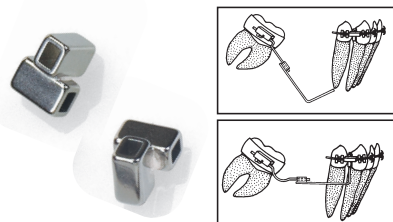

#101-0062 .018

#101-0063 .022



DynaFlex® Nickel Titanium Distalizing Spring

A new revolutionary coil spring which allows you to effectively distalize molars without headgear or lip bumpers. Optimum patient comfort. Produces 150 grams of continuous force when compressed. Cut spring in middle of the closed coils. Each pack contains three 7" pieces. 010 x 045.

#0972

DynaFlex® Bondable Lingual Retainers Starter Kit

Starter Kit Contains: 1 case with 20 cuspid to cuspid bondable retainers: 4 of each size.

#O-953-3032 Starter Kit



DynaFlex® Direct Bond Lingual Cleat



Single unit cast construction allows for superior bond strength. Low-profile design. Smoothness of ball hooks allows for many uses in orthodontic treatment. Pack of 20.

#2015

DynaFlex® Micro Direct Bond Round Lingual Button



These very small low-profile micro buttons ensure patient comfort while still allowing room for tying elastics. Contoured mesh base allows for easy bonding. Pack of 10.

#2017

DynaFlex® Lingual Buttons

Weldable buttons are single-unit cast construction which minimizes patient discomfort. Our new bondable buttons are newly designed and constructed in one piece MIM design for enhanced strength and a flatter profile. Single piece construction provides the ultimate in strength. The rounded edges and corners provide the ultimate in patient comfort. Pack of 10.

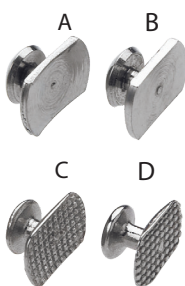

Weldable

#2009 (A) Curved #2009-2.....(B) Flat

#2010 (C) Curved

#2011 (D) Flat

Bondable

DynaFlex® Polycarbonate Buttons



The small size of these low profile buttons allows bonding in hard to reach areas. Pack of 10.

#O-600-1115

DynaFlex® Eruption Chain



Impacted teeth are erupted easily with our new chain system! Simple and easy to use. 10 buttons with chains attached per package. Manufactured from Stainless Steel, contains a small percentage of Nickel.

#2007

Jevan Thumb

Jevan Hand Instruments



Use the Jevan Thumb to hold the lingual wire in position.



Use the Hand Instrument to adapt and hold the lingual wire while bonding.



Lingual retainer is tightly adapted & placed at proper vertical height.

DynaFlex® Jevan System

Place Lingual Bonded Retainers Effortlessly

System Contains: One Jevan Thumb Forcep, Two Jevan Hand Instruments (one maxillary, one mandibular)

- The Jevan Thumb allows easy and precise placement of the lingual wire.
- The Jevan Hand Instrument is used to tightly adapt the wire to the lingual tooth surface.
- The offset tip allows easy & accurate control of the lingual wire.

#O-224-3100

DynaFlex® Bondable Buttons

- Durable & stain-resistant
- Secure dovetail base design
- Aesthetically pleasing appearance
- Pack of 10

#O-600-1113 Composite

#O-600-1114 Ceramic

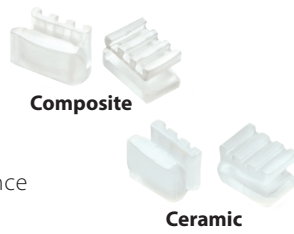

DynaFlex® Multi Lingual Button

Super clear with a super strong bond strength. Patented base created with a central groove and numerous holes which provide maximum bonding strength. Each button has a hole in the neck allowing for .012 to .018 wires to be inserted. Smooth, large dome head makes for ease in bonding and holding auxiliary elastics. Pack of 10.



#2008 Round Base

#2008-05 Rectangular Base

DynaFlex® Coated Koby Ties

Superior quality Teflon® coated Koby ties in toothtone. Available in pre-twisted in .012 short ties. Pack of 100.



#1001-512

DynaFlex® Stainless Steel Ligature Ties

High quality stainless steel preformed ties for easy tying.



Short Ties – 500/pack	
ITEM #	SIZE
#0975-001	.010

Long Ties – 1,000/pack	
ITEM #	SIZE
#0974	.008
#0974-05	.009
#0975	.010
#0976	.012



Have Questions?

We are here to help!

866-346-5665

DynaFlex® Stainless Steel Kobayashi Ties

High quality stainless steel preformed ties for easy tying. Pack of 100.

Long Ties – 100/pack	
ITEM #	SIZE
#1000-010	.010
#1000-012	.012
#1000-014	.014



Short Ties – 100/pack	
ITEM #	SIZE
#1001-012	.012
#1001-014	.014



DynaFlex® Colored Ligature Ties

Stainless steel .012 ligature ties (coated .014). Available in short or long. Pack of 100.



COLOR	SHORT	LONG
Almond	#0975-50	#0975-56
White	#0975-55	#0975-61

DynaFlex® Bondable Lingual Retainer

Each package contains 5 of one size.

SIZES	ITEM NUMBER
22 mm	#O-953-3022
24 mm	#O-953-3024
26 mm	#O-953-3026
28 mm	#O-953-3028
30 mm	#O-953-3030



DynaFlex® Habit Control Device

- Eliminates detrimental forces
- Discourages over-active muscle activity
- Bonds to upper or lower arches
- 80 gauge foil mesh bonding base
- High quality 17-4 stainless steel
- Curved base perfect for lingual placement
- Pack of 10



#O-152-1070

DynaFlex® Spooled Ligature Wire

High quality stainless steel ligature wire is super smooth for easy tying. Available in .008, .009, .010 and .012. One-pound spool.

#0979-008 .008

#0979-009 .009

#0979-010 .010

#0979-012 .012

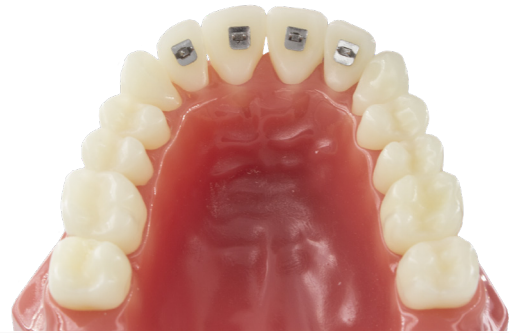

DynaFlex® Flat Lingual Retainer Wire

New to our product line this year! Flat Lingual Retainer Wire, ideal for maxillary and mandibular bonded lingual retainers. Will not fray when cut, can be bonded into place using any type of adhesive. .010x.028.

#1009 10 6" Pieces Per Pack

#1009-10 60" Spool



A Real Orthodontic Products Online Shopping Experience

- ✓ Simplified Shopping Experience
- ✓ View Your Order History, Easily Reorder
- ✓ Bulk Ordering Made Easy
- ✓ You Choose Your Shipping Methods Based On Cost
- ✓ Quick Search & Find Feature

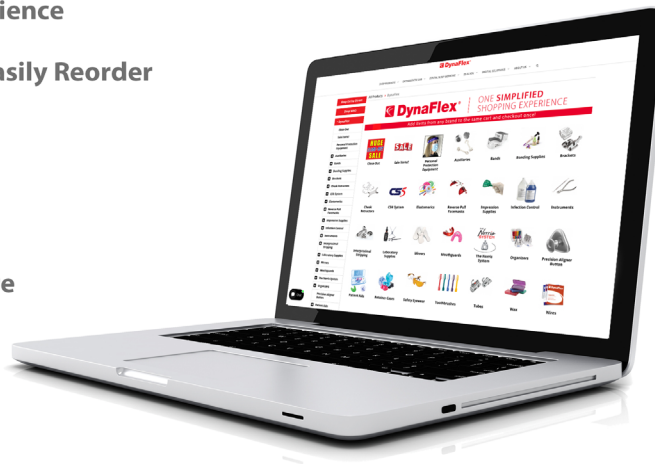

Visit Us Online At
www.dynaflex.com
Click LOG IN on the
top right, use your
existing DynaFlex
User ID & password.

If you don't have a
login, simply click
register on the same
screen for access.

Mini-Mold

DynaFlex® Mini Molds Starter Kit

Mini Mold Starter Kit makes it simple to create your own resin attachments! Each kit contains 3 of each Mini Mold type: Wire Bonders (large and small), Button Bonders, Bite Ramps (3mm and 5mm), Cupid Bite Ramps, Molar Pad Bonder, Habit Control Spikes, Bracket Bonders and Tube Bonders and 2 Handles.

#2045 Mini Mold Kit

#1786 Handles



DynaFlex® Universal Bite Opening Kit

The universal bite opening kit creates various bite opening attachments in seconds. Kit includes 4 each: 4 each of child & adult cuspid bite ramp mini molds, 3mm bite ramp mini molds, 5mm bite ramp mini molds, molar pad mini molds and 2 bonder handles.

#2046



DynaFlex® Peg Lateral Kit

A fast and easy way to convert a peg or undersized lateral to full size lateral. Kit of 4 sizes 2 per size:

7mmUL, 7mmUR, 8mmUL and 8mmUR

#O-152-1028



DynaFlex® Mini-Mold Adhesive Paste

Specially formulated to reduce curing time. Superior bonding strength. Smooth, tacky viscosity. Can be used with any light cure sealant. Available in blue or toothtone. 5 gram syringe.

#2045-10 Blue Mini-Mold Paste

#2045-20 Toothtone Mini-Mold Paste





DynaFlex® Habit Control Bonder

Correct thumb sucking and tongue thrusting w/ minimal chair time.

(10 per pack + handle)

#2045-06

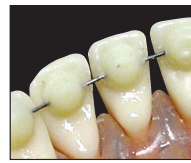
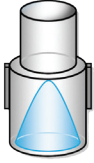

DynaFlex® Wire Bonder

Forms a precise spherical resin mound over an archwire, available in large or small.

(10 pack + handle)

#2045-04 Large \$75.50/pk.

#2045-04S Small

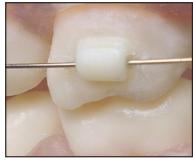

DynaFlex® Tube Bonder

Forms a temporary tube for easy placement on erupting molars.

(10 per pack + handle)

#2045-01

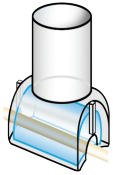

DynaFlex® Button Bonder

Forms a lingual button that can be placed on any tooth. (10 per pack + handle)

#2045-07

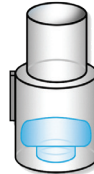

Light Cure Your Own Resin Attachments!



DynaFlex® Hook Molds

Quickly creates a small one-sided hook that is easy to place on the labial or lingual of a tooth for easy placement of elastics. (10 per pack + handle)

#2045-09



DynaFlex® Bracket Bonder

Forms a single wing bracket for simple tooth correction. (10 per pack + handle)

#2045-02



DynaFlex® Cuspid Bite Ramp

Ideal for immediate bite opening when the overjet is in excess of 5mm. Available in adult or Pedito size. (8 per pack + handle)

#2045-25 Cuspid Bite Ramp

#2045-25P Pedito Bite Ramp



DynaFlex® Bite-Ramp Bonder

Forms a bite-opening ramp on the lingual of upper incisors.

(8 per pack + handle)

#2045-03 3mm

#2045-08 5mm



DynaFlex® Molar Pad

Forms a precise spherical mound on the posterior cusps, compliments the anterior bite-ramp for opening the bite from the posterior teeth. (10 per pack + handle)

#2045-05



Mini Molds are ideal for aesthetic attachments. A great solution for sensitive patients. Simply choose from the 6 mold types, fill the mold with light cure resin, and place the mold on the desired tooth and light cure. Fluoride releasing. Available in a kit of 24 (3 of each style) or individual style packages of 10. Bite-Ramp Bonder packaged 8 per pack

ELASTOMERICS





Latex & BPA FREE

DynaFlex® Dyna Stick Ligature Ties

Now, shinier than ever! All of our elastomeric ties are manufactured using the newest materials and latest technology. Our ties now feature a shiny finish that deepens the color while still maintaining the 3/8" stretch and 90% rebound. Superior strength, bright colors, guaranteed not to fade or discolor. 29 attractive colors available! 50 ties per stick - 20 sticks per pack. 1000 Total Ties!

All colors shown in chart on opposite page.

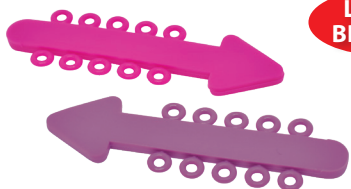

Latex & BPA FREE

DynaFlex® Single Stick Ligature Ties

The same as our Dyna Stick Ligature Ties, but in a smaller stick. Superior strength, bright colors, guaranteed not to fade or discolor. 29 attractive colors available! 10 ties per stick - 100 sticks per pack. 1000 Total Ties!

All colors shown in chart on opposite page.



DynaFlex® Power Chain

Super strong and powerful! DynaFlex Power Chain maintains excellent rebound for extended periods of time, giving you the force you need. We unconditionally guarantee our chain to be of the highest quality available. All the power chain colors match tie colors. 15-foot spool.

Elastomeric Organizers



DynaFlex® Power Chain Organizer w/ Guide Holes

Holds up to 18 spools.

#1494-20



DynaFlex® Power Chain Organizer w/Cover

Strong and sturdy design. Hinged cover for protection. Holds 18 spools of power chain.

#1494



DynaFlex® Power Chain Dispenser

Clear acrylic design easily dispenses chain. Holds up to 12 spools.

#1494-01



DynaStick & Chain Organizer w/Cover

Our custom-built organizer which holds our Dyna Sticks. A great way to view the colors. Twelve tubes to hold Dyna Sticks and a bar to hold 12 power chains.

#1491





















DynaStick Organizer

Holds 12 colors of DynaSticks with clear acrylic lid.

#1491-05

Available Elastomeric Colors

COLOR	COLOR NAME	LIGATURE TIES		POWER CHAIN		
		SINGLE STICKS 	DYNASTICKS 	SHORT 	LONG 	CONTINUOUS 
	Black	#1218-BK	#1216-BK	#1235-BK	#1234-BK	#1233-BK
	Clear	#1218-C	#1216-C	#1235-C	#1234-C	#1233-C
	Cobalt Blue	#1218-CB	#1216-CB	#1235-CB	#1234-CB	#1233-CB
	Fuchsia	#1218-F	#1216-F	#1235-F	#1234-F	#1233-F
	Gold	#1218-GD	#1216-GD	#1235-GD	#1234-GD	#1233-GD
	Hot Pink	#1218-HPK	#1216-HPK	#1235-HPK	#1234-HPK	#1233-HPK
	Kelly Green	#1218-KG	#1216-KG	#1235-KG	#1234-KG	#1233-KG
	Lavender	#1218-L	#1216-L	#1235-L	#1234-L	#1233-L
	Light Blue	#1218-LB	#1216-LB	#1235-LB	#1234-LB	#1233-LB
	Light Green	#1218-LG	#1216-LG	#1235-LG	#1234-LG	#1233-LG
	Light Pink	#1218-LP	#1216-LP	#1235-LP	#1234-LP	#1233-LP
	Maroon	#1218-M	#1216-M	#1235-M	#1234-M	#1233-M
	Metallic Blue	#1218-MB	#1216-MB	#1235-MB	#1234-MB	#1233-MB
	Metallic Silver	#1218-SI	#1216-SI	#1235-SI	#1234-SI	#1233-SI
	Navy Blue	#1218-NB	#1216-NB	#1235-NB	#1234-NB	#1233-NB
	Neon Green	#1218-NG	#1216-NG	#1235-NG	#1234-NG	#1233-NG
	Orange	#1218-O	#1216-O	#1235-O	#1234-O	#1233-O
	Pearl	#1218-PRL	#1216-PRL	#1235-PRL	#1234-PRL	#1233-PRL
	Pearl Blue	#1218-PB	#1216-PB	#1235-PB	#1234-PB	#1233-PB
	Pink	#1218-PK	#1216-PK	#1235-PK	#1234-PK	#1233-PK
	Purple	#1218-P	#1216-P	#1235-P	#1234-P	#1233-P
	Red	#1218-R	#1216-R	#1235-R	#1234-R	#1233-R
	Royal Blue	#1218-RB	#1216-RB	#1235-RB	#1234-RB	#1233-RB
	Sky Blue	#1218-SB	#1216-SB	#1235-SB	#1234-SB	#1233-SB
	Teal	#1218-T	#1216-T	#1235-T	#1234-T	#1233-T
	Turquoise	#1218-TQ	#1216-TQ	#1235-TQ	#1234-TQ	#1233-TQ
	Violet	#1218-V	#1216-V	#1235-V	#1234-V	#1233-V
	White	#1218-W	#1216-W	#1235-W	#1234-W	#1233-W
	Yellow	#1218-Y	#1216-Y	#1235-Y	#1234-Y	#1233-Y

elastomers

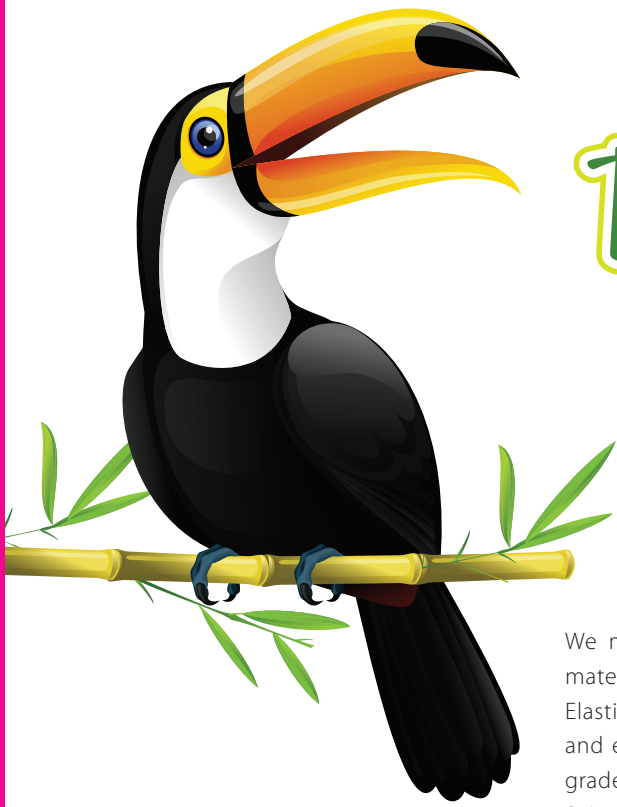

Rainforest[™] Elastics

Available in Latex and Latex Free

We manufacture our latex Rainforest Elastics using prime, medical grade raw material that far exceeds industry quality standards for intraoral use. Rainforest Elastics are perfectly formed and accurately cut to ensure consistent force levels and efficient treatment. Our non-latex elastics are manufactured from a medical grade resin, eliminating any concerns of latex allergies. Both of our Non-Latex & Latex versions of Rainforest Elastics do not absorb water or saliva. Each box contains 50 patient bags of 100 elastics, totaling 5,000 elastics per box.























FEATURES

- Non-latex performs like latex elastics
- Manufactured from a medical grade resin
- Does not absorb water or saliva
- Eliminates the use of heavy talc
- Offers consistent force levels
- Each box contains 50 packs of 100 elastics each



Only prime medical grade latex meets our standards for manufacturing our Rainforest intraoral elastics.

					
	1/8" (3.2MM)	3/16" (4.8MM)	1/4" (6.4 MM)	5/16" (7.9MM)	3/8" (9.5MM)
LIGHT FORCE (2.5 OZ.)	 Ant	 Coffee Beans	 Caterpillar	 Orchid	 Fern
Clear (Amber)	#1200-AL	#1200-BL	#1200-CL	#1200-DL	#1200-EL
Clear Non-Latex	#1207-AL	#1207-BL	#1207-CL	#1207-DL	#1207-EL
MEDIUM FORCE (4.5 OZ.)	 Toucan	 Anteater	 Butterfly	 Water Lily	 Frog
Clear (Amber)	#1200-AM	#1200-BM	#1200-CM	#1200-DM	#1200-EM
Clear Non-Latex	#1207-AM	#1207-BM	#1207-CM	#1207-DM	#1207-EM
HEAVY FORCE (6.5 OZ.)	 Lemur	 Chimpanzee	 Parrot	 Lizard	 Bamboo
Clear (Amber)	#1200-AH	#1200-BH	#1200-CH	#1200-DH	#1200-EH
Clear Non-Latex	#1207-AH	#1207-BH	#1207-CH	#1207-DH	#1207-EH



Extra-Oral Latex Elastics

Always consistent in size and force, activated force is reached when elastic is stretched 3x's its original size. Extra-Oral elastics are available in 8, 14 and 16-ounces in force. Each package contains 1,000 bulk-packed elastics.

SIZE	ITEM #
1/4"	#1200-CE
5/16"	#1200-DE
3/8"	#1200-EE
1/2"	#1200-FE



Elastic Organizer

Specially designed for easy dispensing of intraoral elastics. Holds five different sizes.

#1208-5

elastomers

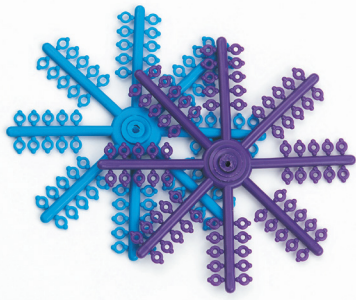

DynaFlex® Safe-T Separators

Finally, a super improvement over the standard separators! This new design has a small knob on each side of the separator to prevent it from being submerged into the sub-gingival area. Safe-T separators are available in slim and standard size. Star-shaped dispenser with 960 total separators per package. Non-Radiopaque.

#1228 Slim (blue)

#1228-01 Standard (purple)

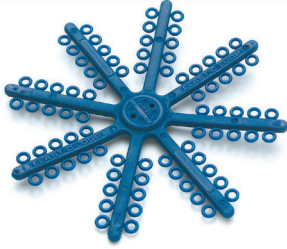

DynaFlex® Star Seps

These separators will be as convenient for your office as they are easy to remove from the module. Smooth, round edges make for easier placement and aid with patient comfort. Twelve modules per package, 960 separators. Radiopaque.

#1230

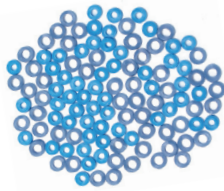

DynaFlex® Bulk Separators

#O-901-1200 Radiopaque. Pack of 1000



DynaFlex® Elastic Tooth Separators

Easy tooth separation for all types of mechanics. Radiopaque. Package of 1000. Radiopaque.

#1222 Posterior Blue



DynaFlex® Brass Separating Wires

For situations when elastic separators will not fit. Flat ends provide for ease when passing through a tight contact. Wire is flexible enough for easy twisting. 100 separators per pack.

#0942 .020

#0942-5 .025



DynaFlex® Niti Tooth Separating Spring

The best way to separate tight contacts. Easier and faster than elastic separators. No patient discomfort. 018 diameter. Pack of 25.



#1014 Large

#1015 Small



DynaFlex® Force Module Separating Plier

Quality made, stainless steel instrument. Specially angulated beaks hold separator in place without sliding off.

#1400-018A

DynaFlex® Rotation Wedges on Canes

True “wedge” shaped design allows for more tooth contact resulting in more efficient movement of the tooth. Designed to keep wires from sliding out of place. Available in gray or clear. 100 rotation wedges per package (10 per cane).

#1003-GY Gray

#1003-C Clear

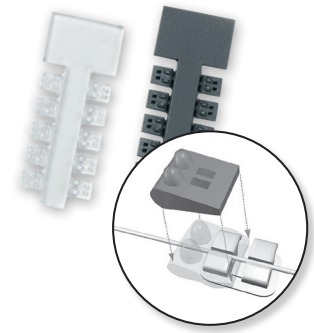

DynaFlex® Rotation Wedges

The wedge portion allows enough force between the wire and the bracket for rotation to occur. Simply slip wedge over one set of the tie wings on the bracket. Pack of 25.

#1004-GY Gray

#1004-C Clear



DynaFlex® Elastic Sleeve

Protective covering for archwires. Reduces tissue irritation. Available in gray or clear. Inside diameter sizes .018 and .027. 10-foot spool. Latex Free.



ITEM #	SIZE	COLOR
#1105-018	.018	Gray
#1105-027	.027	Gray
#1106-018	.018	Clear
#1106-027	.027	Clear

DynaFlex® Ultra-Tuff Thread

This very unique solid thread has a textured surface that allows knots to stay tied secure. Highly stain resistant and maintains force over an extended period of time. Available in .025 or .030. 25-feet per spool. Clear or Gray.

#1108-025 .025

#1108-030 .030

#1109-025 .025

#1109-030 .030



DynaFlex® Elastic Thread

Solid thread is break-resistant. Available in gray or clear. sizes .025 and .030. 25-foot spool. Latex Free.



ITEM #	SIZE	COLOR
#1101	.025	Gray
#1101-030	.030	Gray
#1100	.025	Clear
#1100-030	.030	Clear

DynaFlex® Lip Bumper Tubing

.050 size tubing. Available in gray only. 10-foot spool.

#1102-GY Gray



MultiJust II™: Adjustable Face Masks



Each mask comes with...

- Extra Set of Pads
- Adjusting Wrench
- Additional Screw
- Free Carrying Bag

COLOR	ITEM NUMBER
Red	#O-165-1002
Blue	#O-165-1004
Pearl	#O-165-1006
Green	#O-165-1008
Clear	#O-165-1010

Replacement Pad Set

#O-165-1001

DynaFlex® Release Modules

Modules are used with cervical cushions and high pull straps to make a releasable ("break-away") headgear when a sufficient force is applied. You have a choice of metal or plastic release clips. Each package contains 10 pieces (5 pairs).

Release Module Density:

Low (Light) = 10 oz.
 Medium = 14 oz.
 Heavy (High) = 20 oz.



Plastic Clips

COLOR	LIGHT FORCE	MEDIUM FORCE	HEAVY FORCE
Black	#O-165-5000	#O-165-5002	#O-165-5004
Blue	#O-165-5100	#O-165-5102	#O-165-5104

Metal Clips

COLOR	LIGHT FORCE	MEDIUM FORCE	HEAVY FORCE
Black	#O-165-5006	#O-165-5008	#O-165-5010
Blue	#O-165-5106	#O-165-5108	#O-165-5110

DynaFlex® Cervical Cushions Cotton

- 10 cushions per pk..
- Size: 7.5" x 1.625" x 0.25"
- 3 module attachment locations
- Pack of 10



#O-165-2000 Black.

#O-165-2002 Blue

**Tired Of
 Navigating
 Through Multiple
 Pages And
 Hundreds Of
 Products?**

That Ends Now With...

OnCommand

OnCommand was created to make ordering even easier. We've taken your accounts most ordered items and combined them in an easy to navigate grid that can be filtered by product line and/or searched by item name or item number. **Ordering has never been quicker....**

LEARN MORE:

www.dynaflex.com/oncommand-tutorials/

Champion™ Comfort Fit Facemask

Constructed of stainless steel and unbreakable plastic. The single vertical spindle is ideal for maximum patient comfort and easy fit adjustment. Each facemask includes adjustment wrench and comfort pads.

#0811-R Replacement Pads



FREE
CARRYING CASE



#0811
Blue



#0811-02
Pearl White



#0811-03
Red



#0811-04
Teal



#0811-09
American Flag

DynaFlex® Series 100 Facebows

- Short & regular length outer bow
- Stamped size marks and midline
- One piece inner bow design
- .072" diameter outer bow wire
- .045" diameter inner bow wire
- Silver solder joint method of joining inner and outer bow



BOW SIZE	INNER BOW SIZE	SHORT OUTER BOW	REGULAR OUTER BOW
0	76mm	#O-165-4100	#O-165-4200
1	83mm	#O-165-4102	#O-165-4202
2	90mm	#O-165-4103	#O-165-4203
3	97mm	#O-165-4104	#O-165-4204
4	104mm	#O-165-4106	#O-165-4206
5	111mm	#O-165-4108	#O-165-4208
6	118mm	#O-165-4110	#O-165-4210

DynaFlex® Universal Facebows

- Short & regular length outer bow
- Stamped midline marking
- Solder joint method of joining inner & outer bow
- .072" diameter outer bow wire
- .045" dia. inner bow wire
- One piece inner bow design
- One Size Fits All

#O-165-4000 Short Outer Bow

#O-165-4001 Regular Outer Bow



BONDING SUPPLIES



Reliance®

Light Bond™ Adhesive

Fluoride releasing light cure bonding system recommended for all bracket types: metal, plastic or ceramic. Paste is very tacky to prevent bracket "flotation."



ITEM #	DESCRIPTION
#18-LBEPF	Light Bond Adhesive Kit
#18-LBPPF	5gm Light Bond Paste w/ Fluoride, Toothtone, 5gm
#18-LBBPPF	5gm Light Bond Paste w/ Fluoride, Blue, 5gm
#18-LBMPPF	5gm Light Bond Paste w/ Fluoride, Medium Viscosity, Toothtone, 5gm
#18-LBBPTF	Light Bond Paste in Tips w/ Fluoride, Blue, 11pk
#18-LBMPTF	Light Bond Paste in Tips w/ Fluoride, Medium Viscosity, Toothtone, 11pk
#18-LBPTF	Light Bond Paste in Tips w/ Fluoride, Toothtone, 11pk
#18-LBPTFLN	Light Bond Paste in Long Nose Tips w/ Fluoride, Toothtone, 11pk
#18-LBS3F	Light Bond Sealant w/ Fluoride, 3cc
#18-LBS7F	Light Bond Sealant w/ Fluoride, 7cc
#18-EL9	Liquid Etch, 9gm
#18-CRII	C.R. Syringe Mark II

Rely-A-Bond® Adhesive

Fluoride releasing, no-mix bonding system for metal, plastic or ceramic brackets. Ideal for direct or indirect bonding techniques. Maximum bonding strength within 5 minutes.

ITEM #	DESCRIPTION
#18-RPF	Rely-A-Bond Adhesive Kit
#18-1RPP	Rely-A-Bond Paste, in Push Syringe
#18-RPT	Rely-A-Bond Paste, in Tips, 33pk
#18-RPJ	Rely-A-Bond Paste, in Jar, 14gm
#18-RPRF	Rely-A-Bond Primer w/ Fluoride, 16gm



Reliance® Ultra Band Lok® & Luer Lok Ultra Band Lok Adhesive

Superior Band Adhesive in single syringe means no mixing and no waste. A must for every office. Light Cure only. Ultra Band-Lok® is a Fluoride releasing all purpose cement that can be used to bond brackets, lingual retainers and large acrylic appliances. When bonding these appliances, you must first etch the enamel surface.

Ultra Band Lok®	
ITEM #	DESCRIPTION
#18-UBLPP	Ultra Band-Lok Paste, Toothtone, in Push Sryinge, 5gm
#18-UBLBPP	Ultra Band-Lok Paste, Blue, in Push Syringe, 5gm
Luer Lok®	
ITEM #	DESCRIPTION
#18-LLUBLP	Leur Lok Ultra Band-Lok, Toothtone, in Push Syringe, 5gm
#18-LLUBLBP	Leur Lok Ultra Band-Lok, Blue, in Push Syringe, 5gm
#18-LLTIPS	Leur Lok Tips, 60pk



Band-Lok® Glass Ionomer Dual Cure Cement

Band-Lok® is a Dual Cure, Fluoride releasing, two paste cement. It can be used with or without a dental curing light. When band is placed and flash is cleaned a 20 second light activation allows full protection from moisture. Without light activation a complete set is achieved in 10 minutes. Four minute working time at room temperature without a frozen slab. No messy Powder-Liquid Systems. Consistent mix viscosity every time. Unlike Glass Monomer cements, Band-Lok does not have an aftertaste or odor.

ITEM #	DESCRIPTION
#18-BLSA	Part A Band-Lok Paste, Screw Syringe, 6gm
#18-BLSAB	Part A Band-Lok Paste, Blue Screw Syringe, 6gm
#18-BLSB	Part B Band-Lok Paste, Screw Syringe, 6gm



Reliance® Pad Lock Light Cure Adhesive

Fluorescing Light Cure Adhesive that increases adhesion to even the finest mesh pad bracket bases! Pad Lock contains a monomer that bonds chemically to metal. The paste will fluoresce when illuminated with a black light which allows the operator to disclose flash not removed initially as well as adhesive remnants left after debonding.

ITEM #	DESCRIPTION
#18-PLP	PadLock LC Push Syringe 4.5 gram
#18-PLPF	PadLock LC Push Syringe w/ Fluoride 4.5 gram
#18-PLT	PadLock LC Paste in Tips 4.5 gram - 10 pk
#18-PLTF	PadLock LC Paste in Tips w/Fluoride 4.5 gm - 10 pk
#18-CRII	C.R. Syringe Mark II
#18-AS	Assure Sealant - 6cc



GoTo Light Cure Bracket Adhesive

Formulated with a high filler content, GoTo paste does not allow for bracket flotation once placed on the tooth or as flash is being removed. This filler construction makes for single piece flash removal by being able to remove a single piece without breaking.

#18-GTP Syringe, 4 gram

#18-GTT Syringe Tips, (10) 4 gram tips



FlowTain™

FlowTain™ is a light cured composite with a low modulus of elasticity, which makes it great for lingual retainers, splinting materials, and indirect bonding of brackets. FlowTain™ is also a highly polishable material, which reduces wear. Sold individually with 10 tips.

#1888 Syringe w/tips - Toothtone

#18-22TIPS10 22 Gauge Tips 10pk



Reliance®



Excel Regular Herbst Screw Syringe Kit w/ Fluoride

Unsurpassed bond strength, thin consistency, extended working time. Formulated with a patented fluoride releasing monomer that will not reduce bond strength. Kit contains: 2 Excel Part A 6gm Syringes, 2 Excel Part B 6gm Syringes, 7g Bonding Agent Part A and B, 10cc Plastic Conditioner, 9g Liquid Etch.

#18-EHSF

Self Mix Crown Lok Blue

Metal crown luting cement that bonds chemically stainless steel. Two minute working time. Dual syringe self mixes. Contains fluoride and is blue in color. Each package contains one 5gm syringe and 15 self mixing tips.

#18-SMCLB



Glass Lok Economy Kit-Natural Shade

Dual core Glass Ionomer band cement. Hydrophilic Powder/Liquid Cement for secure band adhesion, bonds in a wet or dry field. Resists washout from under bands. Contains fluoride to protect enamel. Bonds chemically to metal. Dual core or light cure. Kit contains: 3 25gm Glass Lok, 1 100g Glas Lok Powder.

#18-GLE



Retainium

Original TM Alloy Retainer Wire, Lingual Titanium Molybdenum Retention for Fixed Lingual Retention. Flexes interproximally, Nickel free, Lowest profile, .027" x .011" ribbon arch, low profile and Nickel free. 10 6" wires per package.

#1800-RET



Retainium XL

Optimum strength Bet Titanium Retainer Wire for Fixed Lingual Retention, Diastema maintenance, space maintenance and splinting. Flat .027" x .016" ribbon arch, low profile and nickel free. 10 6" wires per package.

#1800-RETXL



GET IN TOUCH!

Want the latest news,
information and promotional
offers from DynaFlex®?

SUBSCRIBE

to our email list



VISIT

www.dynaflex.com/emailsignup/

** Complete and submit the form, and
you will begin to receive emails*



EMAIL

info@dynaflex.com

** Please provide full name, zip code, and
email address you'd like to receive emails.*

We are committed to keeping your e-mail address confidential. We do not sell, rent, or lease our contact data or lists to third parties, and we will not provide your personal information to any third party individual, government agency, or company at any time unless compelled to do so by law.

Reliance®

Bonding Products

Consistent Quality You Can Count On

1st & Final Prophy Pumice

200 sterile cups for individual patients use. Pre-mixed – no messy mixing with water. Just open & apply with prophy cup. Tests show that 1st & Final® will pumice more effectively & rinse cleaner for increased bond strength. No flavoring, fluorides or oils which could leave a film that may inhibit or weaken the bond.

#18-FF



L.C.R. - Light Cure Retainer Paste



ITEM #	DESCRIPTION
#18-LCR	LCR Push Syringe, 5gm
#18-LCRT5	LCR Preloaded Tips, 11pk

L.C.R. - Light Cure Retainer Kit

Light Cure Retainer Kit with a smooth viscosity. Micro+ nano fill for flowable consistency with durability of highly filled composite. Kit contains 4 5g Light Cure Retainer Push Syringes, 2 3CC Light Bond Regular with fluoride, 1 23g liquid etchant.

#18-LCREP

Sponge Pellets by Reliance®

500 pellets per pack.

#18-SP



Ortho Stainless Steel Flextech®

30% Stronger Tensile Strength than Gold OrthoFlex-Tech and 300% increased Torsional Strength over Gold OrthoFlex-Tech. 30 inch spool.

#18-SSOFT



Bond-A-Braid Lingual Retainer Wire

The dead soft wire easily adapts and is excellent for semi-permanent orthodontic splinting of the upper and lower incisors, diastema maintenance and other tooth splinting. .027" x .011: ribbon arch wire, 8-strand braided wire, dead soft, adapts easily. Each tube contains 10 6" wires.

#18-BAB2



Reliance® S.E.P

In this age in which we consolidate as many steps as we can in accomplishing a task, it seems only logical that the next step in bonding is to try to consolidate the etch, rinse, and sealant process into one step. This would be time- as well as cost-effective. This is exactly what you get with our new S.E.P (Self-Etching Primer) Kit. This product consists of two components: an acid etch and a monomer primer. After mixing the two components together this system requires you to rub the material into the tooth for 5 seconds, then deliver two bursts of air to drive off the excess etchant and dry the primer. The bracket can then be placed. Also required is the use of a light-cured adhesive paste system. *Compares to Transbond.

ITEM #	DESCRIPTION
#18-SEPD	SEP Dispenser
#18-SEPR	SEP Refill Cartridge, 4ml
#18-1SEPW	SEP Mixing Well - 1 per pack



*Transbond is a registered trademark of 3M Unitek.

Bond Aligner

Light Cure Aligner Adhesive, secure aesthetic bonds, bond to any clear aligner material. No primers or conditioners required. High modulus of elasticity, bonds ceramic, metal or plastic attachments. 1.4gm syringe with 5 tips.

#18-BA Bond Aligner Syringe (1.4gm)

#18-22TIPS10 22 Gauge Tips (10)



Economy Etchant by Reliance®

Reliance etchant in the economical package saves you money!

ITEM #	DESCRIPTION
#18-EGSS	Green Etch Syringe, 6.5gm
#18-22TIPS10	22-gauge Metal Tips, 10pk.
#18-EL9	Liquid Etch, 9gm
#18-EL24	Liquid Etch, 23gm
#18-EL24C	Liquid Etch, Cherry, 23gm

37% phosphoric acid



Ortho Flextech®

Ortho Flextech® is the next generation of lingual retention. Ortho Flextech® stabilizes orthodontic corrections and prevents rotational relapses. It also improves patient comfort because it lays flat against the teeth. Requires less chair time, and has lasting esthetic due to the 14 karat gold composition. Available only in 30" spools.

#18-OFT2



Reliance®

Bonding Products

Consistent Quality You Can Count On



**Have Questions
Or Need Help Placing Your Order?**

**Chat Live Online or
Call 866-346-5665**

Reliance® L.E.D. Pro Seal

LED Pro-Seal a light-cured, fluoride-releasing, filled sealant with a proprietary catalyst. This catalyst allows for the complete polymerization of the Pro-Seal without an oxygen-inhibited layer, and consequently no porosity. L.E.D. Pro-Seal is intended to seal the enamel surface around the base of the brackets. In essence, it is placing a clear plastic protective layer on the enamel surface that will not break down in the presence of oral fluids, abrasive foods, or carbonated beverages. 6ml bottle. *Compares to Ortho Solo.

*Can be used with
any LED light*



#18-LEDPRO

Assure® Plus

An all surface bonding resin! Now it is possible to bond to every intraoral surface with just one primer! No need to stock multiple surface special bonding conditioners. Assure™ Plus allows you to bond directly to normal, atypical, wet or dry enamel, dentin and defective enamel, gold, amalgam, stainless steel and composite, restorations, porcelain and zirconia. Assure™ Plus is compatible with all light and chemical cure pastes.



#18-PLUS

Porc-Etch

Porcelain etch with 7cc Barrier Gel allows for prep to use bonding adhesives with glazed porcelain crowns.

#18-1POE



Plastic Conditioner

The Reliance Plastic Appliance Conditioner is intended for use as a conditioner of plastic brackets or acrylic appliances in preparation for bonding with any adhesive, sealant or cement. It can also be used to condition a composite restoration or acrylic jacket prior to bonding and to rebond a bracket impregnated with adhesive. 10cc.

#18-PL



Metal Primer

Metal primer is used to prepare metal surfaces for use with a bonding adhesive. 8ml.

#18-ME



Porcelain Conditioner

Porcelain Conditioner is used to prepare glazed porcelain for use with a bonding adhesive. 8cc.

#18-PO



Pro Seal

Pro Seal is the first sealant, chemical or light cure, that will completely set without an oxygen inhibited layer. This creates a smooth hard surface that prevents leakage, protects the enamel, and makes paste cleanup easier. 6ml.

#18-PRO



Renew Finishing Points

The Renew Finishing System Points #383 will remove small residual amounts of adhesive from the tooth surface and will polish the enamel without damage. It's rubberized tapered shape facilitates removal of adhesive close to the gingiva. The #383 Point is the second step in the Renew Finishing System Points. Each pack contains 12 points.



A. **#18-RSPFG**

B. **#18-RSPHP**

Renew System Burs #218

The #218 bur is an 18 fluted design that is tapered to reach into those tight areas along the gingival & occlusal when removing residual adhesive. The wide flutes self clean. These burs are the first step in the RENEW™ FINISHING SYSTEM. Sold Individually.



#18-RSB2

Finishing Bur

Our high quality Carbide Finishing Burs allow you to remove cement without damage to the enamel. They trim more predictably and smoothly, and are less pressure sensitive. Because our finishing burs remove bulk and leave you with a smooth surface finish, they are the perfect choice for finishing your debonding appointments with ease. 5 per pack.



#1804

Renew Finishing Bur Straight Handpiece

The #815 lingual composite bur with its friction grip, custom length and cutting head, make this the ideal carbide bur for lingual composite removal. These burs are the first step in the RENEW™ FINISHING SYSTEM Sold Individually.



#1800-RSB815

Renew System Bur

The Renew System Bur has a longer shank for excellent adhesive removal. It's non-tapered friction grip bur cuts quickly and wide flute is self-cleaning. Sold individually.

#18-RSBL 118L

#18-RSB 118S





MI Paste® and MI Paste Plus™

MI Paste and MI Paste Plus contain RECALDENT™. RECALDENT™ is a special milk-derived protein that can help replace lost minerals in teeth, making them stronger and helps protect them from decay and erosion. A one-of-a-kind take-home dental product!

- #9-004505 MI Paste (10 Tubes Of Strawberry Only)
- #9-003679 MI Paste (10 Tubes Of Mint Only)
- #9-002886 MI Paste Plus (10 Tubes Of Strawberry Only)
- #9-002888 MI Paste Plus (10 Tubes Of Vanilla Only)
- #9-002265 MI Paste® (10 Tubes)
- #9-002614 MI Paste Plus™ (10 Tubes Of Assorted Flavors)
- #9-002621 MI Paste Plus™ (10 Tubes Of Mint Only)



MI Paste®:

- Before and after tooth whitening
- For pregnant women
- For children under 6
- During and/or after orthodontics
- For desensitizing
- To provide extra protection for teeth

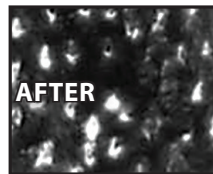

MI Paste Plus™:

- Extra protection for the teeth
- After tooth whitening
- For desensitizing
- During and/or after orthodontics
- For medically compromised patients
- For Salivary deficiency; dry mouth
- For patients with acidic oral environments
- For erosion and gastric reflex
- For patients with poor plaque control
- For high-carries risk patients

GC Fuji® Ortho™ Band Paste Pack Self-Cure

GC Fuji ORTHO BAND is a blue-colored resin modified glass ionomer band cement. The dispenser system has a metering slide that allows for consistent mixes every time. Simply adjust the slide and squeeze out the exact amount needed. Mix dispensed paste for 20 seconds, you'll have a 3-1/2 minute working time and final set will be 3 minutes after. Blue color allows for easy clean up and removal.



- #9-439460 Paste Pack Starter Package
- #9-001888 Band Paste Pack Refill (2-13.3gm paste pack cartridges)
- #9-001573 Paste Pack Dispenser



Fuji LC Automix

GC Fuji Ortho LC is a dual cured resin reinforced glass ionomer cement that is now available in an easy to use automix paste pack. Releases fluoride long term which aids in the prevention of white spot lesions. The accompanying GC Fuji Ortho Gel Conditioner is a polyacrylic gel solution (approximately 20%) designed to mildly condition the enamel. Conditioner is available in a syringe delivery system with brush tips for easy application.

#9-439487 LC Paste Pack Automix Starter Set Contains: 1 Paste Pack Cartridge (13.5 gms), 1 Paste Pack Dispenser, 2 Ortho Gel Conditioner Syringes (1.4 gms each), 20 Mixing Tips and 15 Brush Tips

#9-003103 LC Automix Refill Contains: 2 Paste Pack Cartridges (13.5 gms each)

#9-003102 LC Paste Pack Automix Set Contains: 1 Paste Pack Cartridge (13.5 gms), 2 Ortho Gel Conditioner Syringes (1.4 gms each), 20 Mixing Tips and 15 Brush Tips

#9-003104 Gel Conditioner

#9-423008 Mixing Tips for LC Refill (20 mixing tips)



GC Fuji Ortho Band LC Automix

GC Fuji Ortho LC and GC Fuji Ortho Band LC are dual cured resin reinforced glass ionomer cements that are now available in easy-to-use automix paste packs. Both release fluoride long term, which aids in the prevention of white spot lesions. The accompanying GC Fuji Ortho Gel Conditioner is a polyacrylic acid gel solution (approximately 20%) designed to mildly condition enamel. Conditioner is available in syringe delivery with brush tips for easy application.

#9-439466 GC Fuji Ortho Band LC Paste Pack Starter Kit Contains:

2 Paste Pack Cartridges (13.3 grams each), 1 Paste Pack Dispenser, 20 Mixing Tips and 1 Mixing Pad

#9-003105 GC Fuji Ortho Band LC Paste Pack Refill Contains:

2 Paste Pack Cartridges (13.3 grams each) and 1 Mixing Pad

#9-423008 GC Mixing Tips for LC Refill (20 mixing tips)

GC Fuji Ortho™ Self-Cured Bonding Adhesive

Just like Fuji ORTHO LC, Fuji ORTHO SC will provide you with excellent bonding success and minimizes the chance of enamel damage and decalcification at debonding.

Excellent for bonding brackets
& acrylic appliances!



#9-439503 Fuji ORTHO SC Standard Package (40gm powder, 2-6.8ml liquid)

#9-000210 Fuji ORTHO SC Liquid Refill (6.8ml)

#9-000209 Fuji ORTHO SC Powder Refill (40gms)



Bonds in a wet field
without etching!

GC Fuji ORTHO™ LC

Fuji ORTHO LC is a light-cured resin modified glass ionomer that bonds bracket, attachments and appliances to enamel, porcelain and metal restorations. Fuji ORTHO LC features low sensitivity to moisture. Available in both powder-liquid and capsules.

- Simplified wet field bonding saves time!
- No enamel etching required
- Significant Fluoride Release reduces decalcification
- Greater Efficiency--users experience 15-30 minute time savings per case start



#9-439401 Intro Kit (15gm powder, 6.8ml liquid)

#9-439403 Standard Kit (40gm powder, 2-6.8ml liquid) #9-000029 Powder Refill (40gms).

#9-000030 Liquid Refill (6.8ml)

#9-001820 Conditioner (25gms, liquid)

GC Fuji ORTHO™ LC Capsule

Fuji ORTHO LC is a light-cured resin modified glass ionomer that bonds bracket, attachments and appliances to enamel, porcelain and metal restorations. Fuji ORTHO LC features low sensitivity to moisture. 50 capsules per box.

#9-439450 Capsules (50 capsules)

#9-437555 Capsule Applier

#9-003680 CMI Cap Mixer

Low sensitivity to moisture



improve
bonding up
to 30%

DynaFlex® Tooth Dryer

This warm air dryer provides a light, warm flow of air to ensure superior bonding. Can improve bonding up to 30%. Dryer comes with one replaceable tip. Only white tip is Autoclavable!

#0785 Dryer

#0786 Tip (Black & White)

#0787 White Tips (10pk)



Tooth Dryer

Complete with 2 Tips

- 2 temperature settings
- Improves bond strength up to 30%
- Dryer comes with replaceable tips

#O-301-1001 Tooth Dryer with 2 Tips

#O-301-1002 Replacement Tips (2)

#O-301-1003 Neck

#O-301-1004 Tooth Dryer Holder

Champion™ Pre-Mixed Prophy Pumice

A special formulation that has no effect on bond strength. Our pre-mixed pumice does not contain any fluoride, oils, flavoring and will not splatter. Package of 200 pre-mixed cups and one finger holder per box.

#4401-05



First Step: Pre-Mixed Prophy Paste In Cups (Fluoride Free)

Premixed prophylaxis paste in convenient single unit cups. Clean teeth prior to acid etching or crown cementation without leaving residue. No Fluoride so there's no effect on bond strength. No flavoring agents, splatter, oils or waste. Each box contains 200 Cups and 1 Holder. Box of 200.

- No Fluoride
- No Splatter
- No Flavoring Agents or Oils
- No Waste
- No Effect on Bond Strength

#O-108-1000



Ketac-Cem®

Ketac-Cem® adheres to both tooth structure and metal oxides with no conditioning for an easier technique than hybrid cements.

- Radiopaque
- Low coefficient of thermal expansion
- High fluoride release
- Ideal setting characteristics
- Stability
- Exceptional adhesion



Ketac Triple Kit

Three 33g bottles of powder & three 12ml bottles of liquid

#O-120-1010

Ketac Cement Powder Only

33g

#O-120-1011

Ketac Cement Liquid Only

12ml

#O-120-1012

Etch-Rite™: Etching Gel 38% Phosphoric Acid

Etch-Rite is a superior quality dental etching gel specially formulated or maximum working and handling characteristics.

- #1 seller through dental dealers in the U.S.
- Washes off easily, stays where placed

#O-115-1157 Kit Includes: 4x1.2ml syringes + 8 pre-bent tips

#O-115-1158 Bulk Pack Includes: 24 x 1.2ml syringes gel





Champion™ Etch Gel

Available in regular or mint flavor. Contains 37% Phosphoric acid. Allow etch to penetrate tooth surface for 30 seconds. Available in 2 ounce bottle or 12 gram syringe.

- #1798 2 oz. Bottle - Regular
- #1799 2 oz. Bottle - Mint
- #1820 12 Gram Syringe
- #1821 Disposable Tips - Bag of 50



Blue Etch: Silica-Free Enamel Etch

Silica-Free easy rinse formula. Viscous etch in bottles is slightly thinner than a gel but thicker than water. 37% phosphoric acid.

Viscous Etch In Bottles

- #O-115-1040 2 oz. bottle
- #O-115-1042 8 oz. bottle
- #O-115-1044 12 oz. bottle

Gel Style Etch In Syringes

- #O-115-1046 12g syringe (with 25 disposable tips)
- #O-115-1048 60g syringe (w/five 5g refillable syringes & 20 tips)



Green Etch: Viscous Etch-Green

Green color contrasts with tissue. Viscous etch has a honey-like consistency, thinner than a gel, but thicker than water. 37% phosphoric acid.

Viscous Etch in Bottle

- #O-115-1032 8 oz. bottle
- #O-115-1034 12 oz. bottle

Gel Etch Syringes

- #O-115-1038 60g syringe (w/five 5g refillable syringes & 20 tips)



DynaFlex® Prophylaxis Polishing Cups

An economical screw-shank or snap-on type cup available to fit all prophy angles or prophy sticks. Each designed for maximum delivery of prophy paste to the tooth surface with minimal splatter. Each are a package of 144.

- #O-108-1012 Snap-on
- #O-108-1013 Screw-on



DynaFlex® Propphy Sticks Heat Sterilizable

- #O-108-1005 Snap On
- #O-108-1006 Screw On

DynaFlex® Mixing Pads

- Poly-Coated
- 100 sheets per pad
- Non-Skid Foam Base
- Package of 4

#O-115-1090 3" x 3" pads

#O-115-1092 3" x 6" pads



DynaFlex® Mixing Pads

Coated surface is great for mixing cements. 50 sheets per tablet; 5 tablets per package.

#1885-L 3" x 5" pads

#1885-S 2½" x 2½" pads

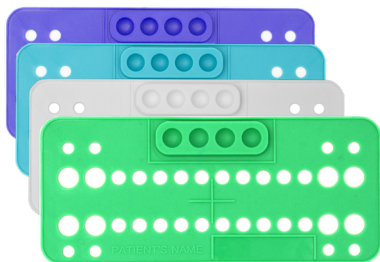

DynaFlex® Bonding Trays - Disposable

Each type holds one full set-up of brackets for direct bonding. Available in blue or teal, with mixing wells. Pack of 25.

#1888-11 Blue

#1888-21 Teal

#1888-31 White

#1888-41 Green

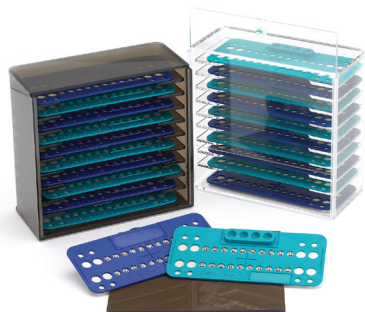

DynaFlex® Bonding Tray Holder

Get organized and ready for the day! Set up your patient bonding trays and place them in our uniquely designed Bonding Tray Holder. Everything you need is just a slot away. Made out of a UV conditioned plastic, the Bonding Tray Holder is even perfect for doctors using LC adhesives. Holds 10 bonding trays.

#1890 Clear

#1891 Smoke

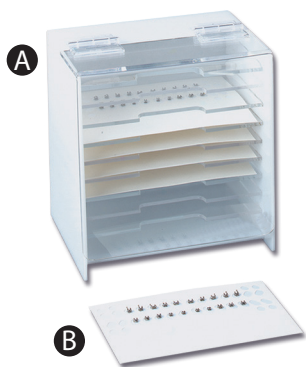

- Adhesive backing holds brackets firmly in place
- Liquid impermeable surface for mixing
- Easy bracket access speeds selection
- Padded for easy dispensing

A DynaFlex® Bonding Pad Organizer

Dimensions: 6.25"W x 6.75"H x 4.75"D

#O-600-1040

B DynaFlex® Disposable Bonding Pads

Pad of 25 Sheets

#O-600-1038



DynaFlex® Zand® Gauge - Perfect Bracketing Position Every Time

A unique and easy to use marking device to aid in correct bracket placement. After acid etching and conditioning with primer, anterior teeth are marked with the straight gauge. Posterior teeth are then marked with contra angle gauge as far back as the second molars. Then, simply line up the bracket slot with the mark on the tooth. Marks are easily removed by brushing the teeth. Each Zand Gauge Kit includes EIGHT gauges, 1-31/2mm, 3-4mm, 1-41/2mm, 3-5mm. Gauges are cold sterilizable. PATENTED # 5312248

#1322



DynaFlex® Microbrush® Disposable Applicators

Microbrush® Applicators have a patented design with a bendable neck that facilitates placement in hard-to-reach areas. Non-absorbent and non-linting fibers suspend solution as small as 1/8 of a drop. No dripping or spilling. Each package contains 4 tubes of 100 applicators each. Applicators are available in an assorted pack.

#1590-05 Multi-Colored Box



DynaFlex® Bonding Brushes

Our superiorly constructed 2" brush is now more economical than ever! Each pack contains 250 brushes.

#1783



DynaFlex® 6" Bendable Brushes

- Easy to bend, stays bent
- 6" for easy access to posterior areas
- Pack of 144

#O-125-1010

DynaFlex® 2" Bendable Bonding Brushes

Handle And Brush In One



Same great qualities as our regular Bonding Brushes but with a Bendable neck for easier access to hard to reach areas. Ideal for etchants, bonding agents, sealants, and adhesives and resins.

#O-125-1015 Box of 400

DynaFlex® 2 1/4 Bonding Brushes

Handle and Brush In One



Quality bristles allows for greater carrying capacity and spreading action. Ideal for..

- Etchants
- Sealants
- Bonding Agents
- Adhesives & Resins

#O-125-1016 Box of 400

DynaFlex® Mini Sponges

- Foam pellets measure: 1/8" x 1/8"
- Convenient poly dispenser
- 200 pellets



#O-125-1026

DynaFlex® Plastic Spatulas

White plastic spatulas are perfect for mixing cement. 4 1/2". Pack of 100.

#1886



DynaFlex® BOND LIGHT - L.E.D. Light Curing Wand

- State-of-the-art technology
- Super High Luminosity L.E.D. (1,000 - 1,200mW/cm²)
- High Quality light guide minimizes loss of light at tip
- Highly Efficient heat sink keeps things cool
- Operates cordless or plugged in
- Up to 200 Bonds per charge
- Timer Settings from 10 - 40 seconds (in 10 second intervals)
- 1 year warranty

#O-190-6060 Black

#O-190-6063 Blue

#O-190-6061 White



DynaFlex® Disposable Curing Light Sleeve

Pack of 100

#O-190-6053

DynaFlex® Turbo Curing Light

- Built in radiometer
- Intensity up to 2,400 mW of power.
- Light wavelength between 440 and 480 nm.
- Cordless, lightweight
- Long-lasting rechargeable battery.
- Auto sleep mode to save battery life.
- 6 powerful extensive modes
- 3 sec. turbo mode.
- Advanced cooling system to protect from overheating and guarantees safe and flawless performance.



#WL090

DynaFlex® Turbo Curing Light PLUS

- Cures composites over 2mm in 2 sec. in turbo mode.
- High power 10W broadband LEDs
- Average lifespan of 100,000 hours
- Radiant intensity Up to 2400mW/cm²
- 8mm light rod
- Easy to change cartridge battery
- Multifunctional light allowing 2-second cure in "turbo" mode as the highest mode
- Considered to have two main functions: Light Curing and Plaque/Caries Detector
- 8mm and 5mm tip included



#WL090+

DynaFlex® Light Cure Glasses

Protects against halogen curing light exposure. Adjustable temples allow for varied protective angles, provides wraparound protection.

A. #0831 Skyper Orange

B. #0832 Orange Blockers



DynaFlex® Light Curing Glasses

Filters out 98% of dangerous blue light and 100% protection from UV light. Impact resistant. Non-distorting and optically correct.

#0824-011



DynaFlex® Disposable Spandeez Retractor

This retractor, similar in style to the well-known Expando is now available as disposable! Available in Medium (blue) and Large (red). Sizes are color-coded for easy identification. Pack of 10.

- #1358-S Small (green)
- #1358-M Medium (blue)
- #1358-L Large (red)

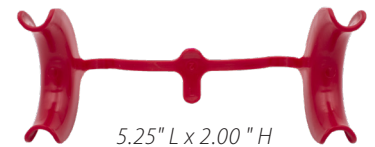

A Real Orthodontic Products Online Shopping Experience

- ✓ Simplified Shopping Experience
- ✓ View Your Order History, Easily Reorder
- ✓ Bulk Ordering Made Easy
- ✓ You Choose Your Shipping Methods Based On Cost
- ✓ Quick Search & Find Feature

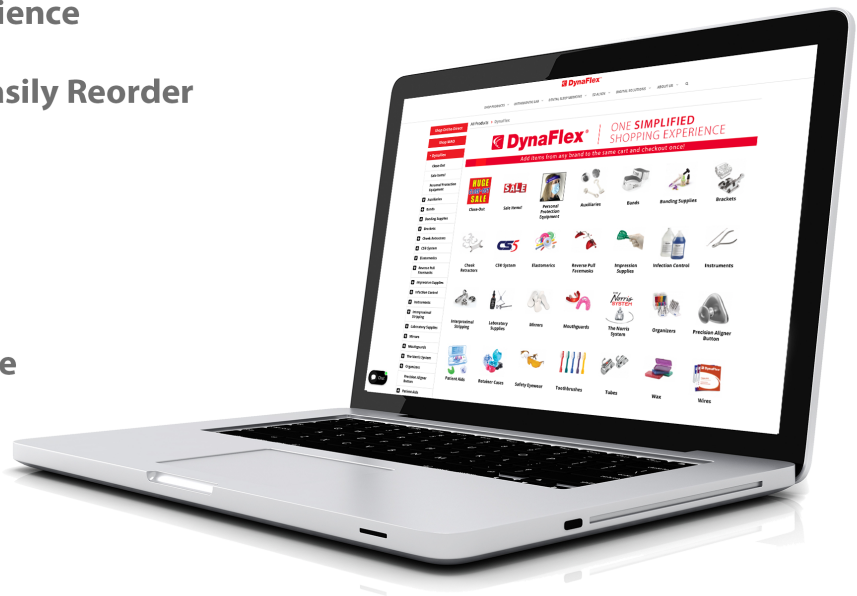

Visit www.dynaflex.com, Click LOG IN on the top right, use your existing DynaFlex User ID and password. If you don't have a login, simply click register on the same screen for access.

DynaFlex® Nola Dry Field System

Keep A Dry Field With The Help Of This System

Allows for full arch access while still being comfortable for the patient. The System completely eliminates saliva and fully exposes both dental arches making it ideal for all bonding applications. Easy to assemble and can be inserted and used by a single operator. Available in two sizes, child or adult. Autoclavable up to 260°.

#1363 Child (Red)

#1364 Adult (White)

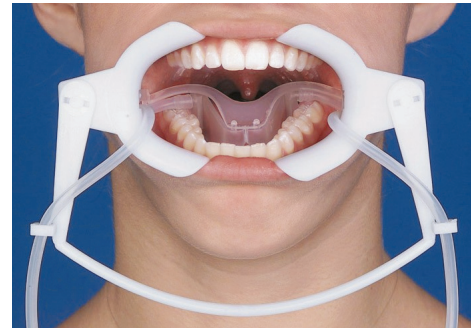

full arch access while still being comfortable for the patient

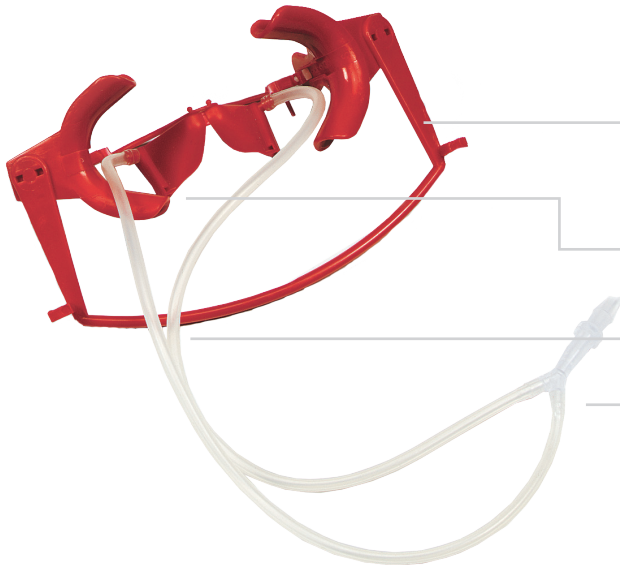

Adjustable Cheek Retractors

Keeps the cheeks back and fully exposes both dental arches.

Tongue Guard

Holds the tongue in place and allows the patient to continue swallowing.

Low or High-Volume Bilateral Silicone Tubing

Part of the unique central suction system that precisely directs saliva flow and ensures unrestricted evacuation for a totally dry environment.

Central Suction

"Y" connector with low-volume adapter.

DynaFlex® Nola Center Connector Arm - White

Center connector for Nola Retractor. Sold individually.

#1365-405



DynaFlex® Adjustable Cheek Retractor

#1365-A Adult White Retractor Only (5.50" x 2.00").

#1365-C Child Red Retractor Only (5.25" x 1.75")



DynaFlex® Silicone Tubing

10 per pack

#1364-T



DynaFlex® Low Volume Adapters w/ "Y" Connectors

#1365-409 4 Adapters



DynaFlex® Y Connector

#1364-Y 4 per pack



DynaFlex® High Volume Adapters w/ "Y" Connectors

#1365-411 4 Adapters



DynaFlex® Tongue Guard

Pack of 2

#1365-403 Lg White

#1365-413 Sm Red





DynaFlex® Stainless Steel Cheek Retractor

Only use the best! Manufactured of high quality stainless steel with a brushed finish. Double-ended with a large retractor at one end and a small retractor at the other end. Can be sterilized by any method. One per package.

#1345 (4.00" L x 1.50" H)



DynaFlex® Double Ended Expander

The only expander you will ever need for photography. Available in pedo/small and med/large. 2 per pack. Cold sterile only.

#1350-05 Pedo/Small (1.25"/1.50" H x 5.50" L)

#1350-06 Medium/Large (1.50"/2.00" H x 6.25" L)



DynaFlex® Retract-EEZ™ Cheek Retractor

This new cheek retractor is excellent for occlusal photographs. Angled bend helps to retract lips comfortably. Cold sterilizable or heat sterilizable up to 290° F.

#1349 (6.25" L x 2.50" H)



DynaFlex® Soft-Dex Retractors Autoclavable

These soft and pliable easy to place retractors are ideal for patient comfort. Provides a full view of the anterior and posterior regions. Available in Adult and Child sizes. Autoclavable up to 255° F. Two retractors per package.

#O-110-1004 Child (4.50" L x 1.50" H)

#O-110-1005 Adult (5.25" L x 1.75" H)



DynaFlex® Wire Cheek Retractors

Comfortable for patient, easy tension control. Can be autoclaved, dry heat or chemically sterilized. Heat sterilizable up to 375 degrees. Adult or child sizes. One per pack.

#1333 Adult (5.75" L x 2.00" H)

#1334 Child (4.75" L x 1.50" H)

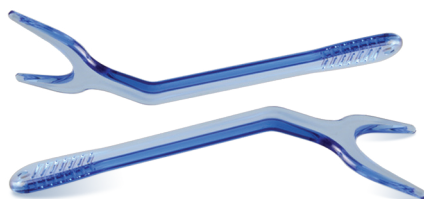

DynaFlex® EZ-Retractor

Allows Unrestricted Access

Great for occlusal photos and quick direct bond repair. Extremely comfortable for patients. Angle head helps retract lips. Autoclavable up to 275°.

#O-110-1055

DynaFlex® Cheek Retractor

Assures a full view for direct bonding of anterior or posterior teeth. Excellent for photography also. Self-retaining. Two per pack. Available in adult, child and teen size. Cold Sterile. Do NOT allow metal to touch during sterilization.

- #1350 Adult (5.00" L x 1.75" H)
- #1350-11 Teen (4.75" L x 1.50" H)
- #1351 Child (3.50" L x 1.25" H)



DynaFlex® FotoTract

Angled Head is ideal for photography allowing unrestricted views. 2 sizes assures patients comfort. Cold Sterilizable or Autoclavable up to 121° Celsius.

- #O-110-1070 Small FotoTract - One Per Pack
- #O-110-1072 Large FotoTract - One Per Pack



DynaFlex® Double Ended Retractors

- Autoclavable Up To 275° F
- High quality autoclavable retractor
- Smooth rounded ends for patient comfort
- Small/Medium Set of 2

#O-110-1028



DynaFlex® X-Spando Retractors:

- High quality & extremely durable.
- The best for bonding.
- Autoclavable up to 275°F.

- #O-110-1086 Small
- #O-110-1087 Medium
- #O-110-1088 Large



Manufactured by
DynaFlex® in the USA

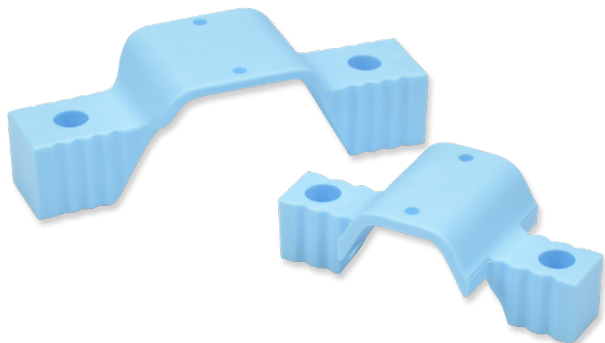

DynaFlex® Tongue Blocks

Use our Tongue Blocks to help the patient relax their jaw during direct bonding procedures. Made of high quality low density polyethylene plastic and manufactured with breathing holes to keep your patient comfortable. Unscented, sizes Small or Medium. 50 per pack.

SIZE	ITEM #
Regular	#13-500
Small	#13-501



DynaFlex® Spandex Cheek Retractors: Autoclavable Up To 275° F

Available in Adult, Child, and Teen Sizes.

#O-110-1010 Child set of 2 Retractors

#O-110-1011 Teen set of 2 Retractors

#O-110-1012 Adult set of 2 Retractors



DynaFlex® Mirasoft Retractors: Autoclavable

These soft and pliable retractors feature long handles and are ideal for patient comfort.

Available in Adult and Child. Sets of 2.

#O-110-1000 Child

#O-110-1001 Adult



DynaFlex® Handheld Cheek Retractors: Autoclavable Up To 275° F

The original cheek retractors. Clear plastic with long handles. Can be cold sterilized.

Available in Adult and Child. Sets of 2.

#O-110-1008 Child

#O-110-1009 Adult



DynaFlex® Mirahold® Cheek Retractor

This unique retractor allows you to control the force. Excellent for photography.

Autoclavable. One set per pack. Adult or child. Cleaning Or Disinfection:

Do Not Exceed 93° C. Sterilization: Vapor Sterilization At 121° C For 15 Minutes.

#1352 Adult (4.50" L x 2.00" H)

#1353 Child(4.25" L x 1.50" H)



DynaFlex® The Original Expando® Cheek Retractor

The Expando brand is the best known around the world for quality and durability. The best

expander for bonding. Available in Small, Medium, Large. One per pack. Autoclavable up to

230° F.

#1355-1 Small - #1(3.25" L x 1.75" H)

#1355-2 Medium - #2 (4.00" L x 1.75" H)

#1355-3 Large - #3 (4.25" L x 2.00" H)

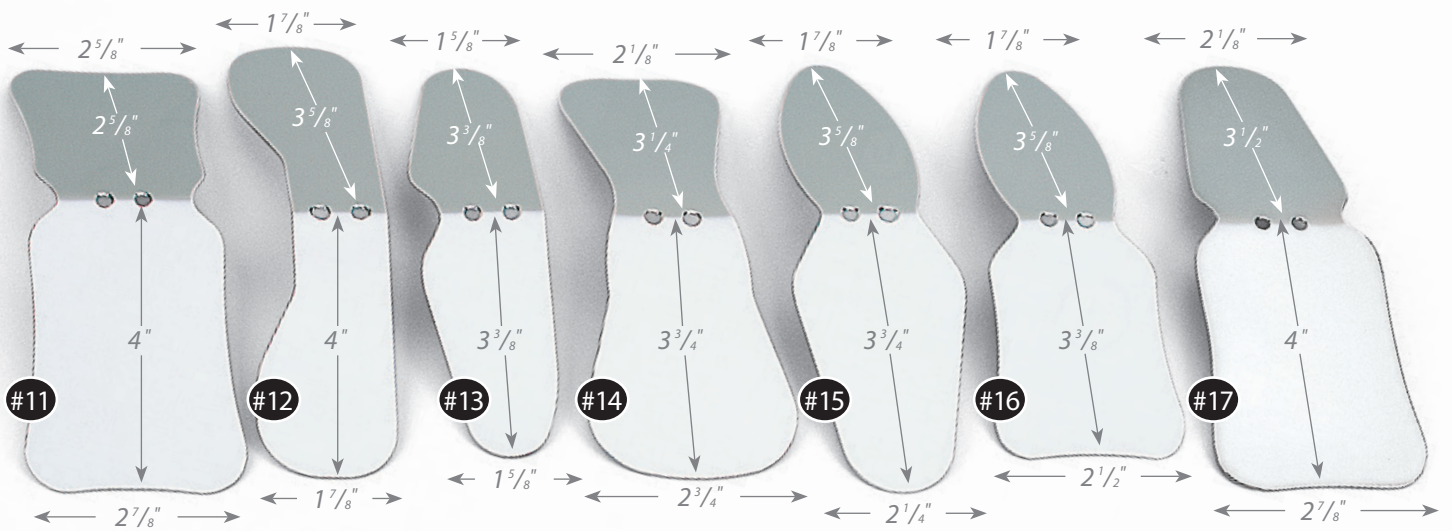

DynaFlex® Photographic Mirrors - Plated

Our most popular photographic mirror! Laser cut stainless steel for precision and accuracy without the risk of breakage. Polished to perfection and then coated for the absolute best resolution. Mirrors are double-ended and angled for ease of use. Satisfaction guaranteed! Cold sterilization is not recommended, heat sterilization is the best sterilization method for these mirrors.

#0795-11 Occlusal #11

#0795-12 Lingual #12

#0795-13 Buccal #13

#0795-14 Occlusal - Child & Adult #14

#0795-15 Buccal - Child & Adult #15

#0795-16 Child Occlusal & Lateral #16

#0795-17 Adult Occlusal & Lateral #17

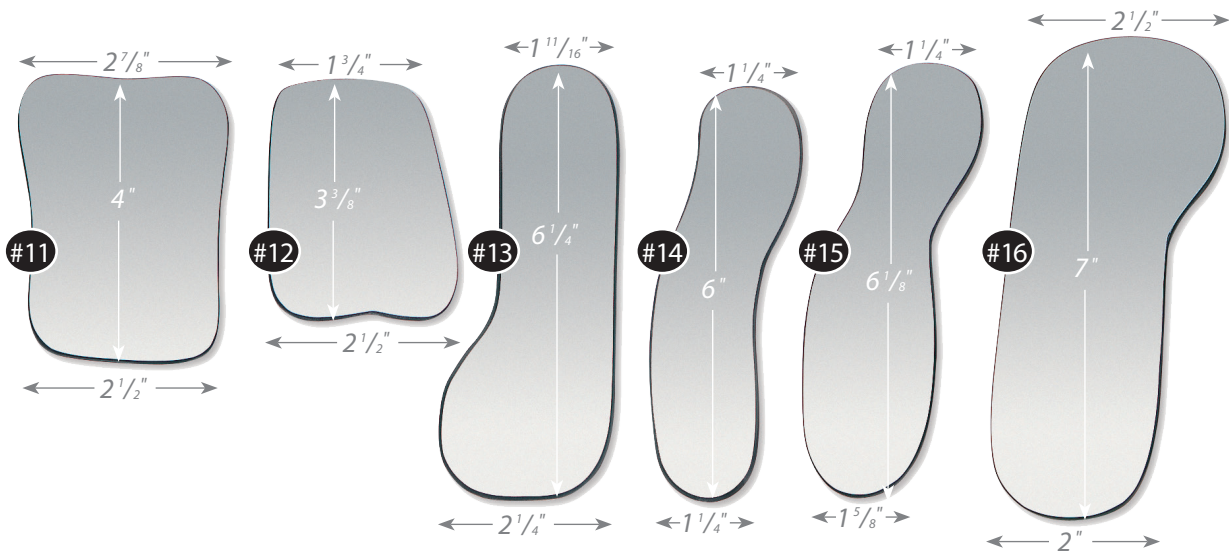

DynaFlex® Photo Mirrors

Actual mirror surface mirrors provide excellent light reflectivity. Mirrors have rounded edges that are comfortable for the patient. Chip resistant and can be sterilized up to 350 degrees.

#0794-11 Palatal (Adult) #11

#0794-12 Palatal (Child) #12

#0794-13 Lingual #13

#0794-14 Buccal #14

#0794-15 Large Lateral #15

#0794-16 Large Occlusal #16

DynaFlex® Photography Mirrors: Stainless Steel

Our stainless steel mirrors offer the ultimate in durability. Highly polished stainless steel surfaces cannot chip, crack, or peel. Double sided for maximum life, the mirrors have polished, rounded edges for patient comfort and are compatible with autoclave sterilization. Highly Reflective, Precision Laser Cut, Double-Sided.

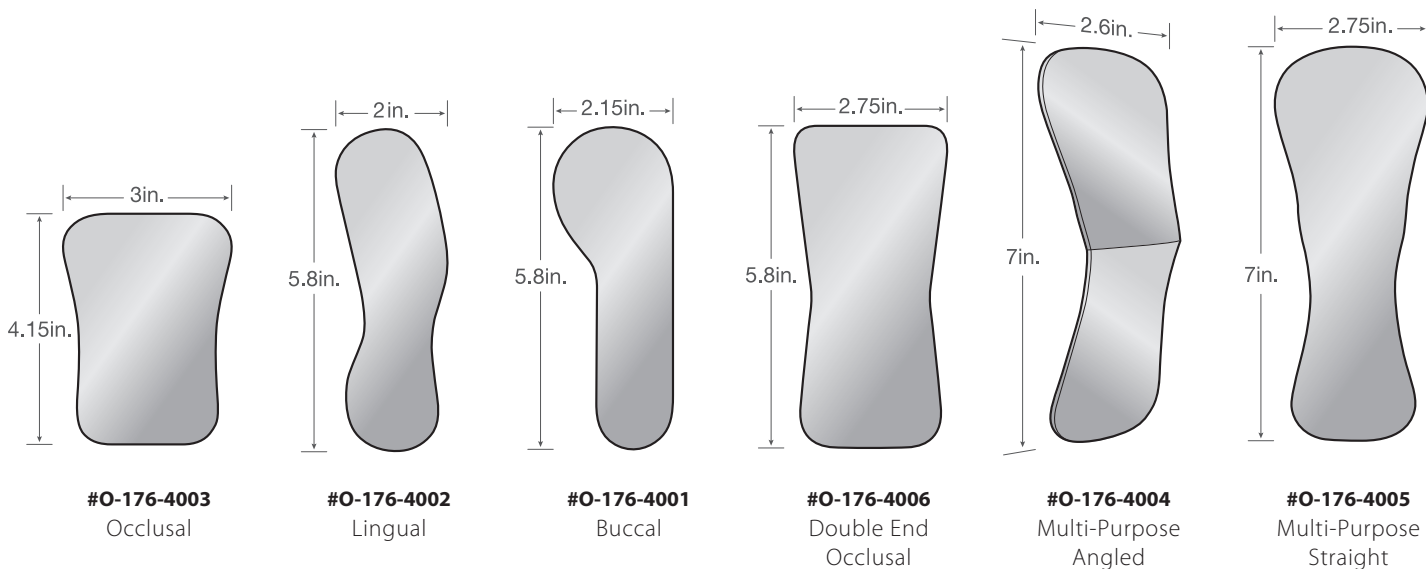

DynaFlex® HR Coated Glass Photography Mirrors

Select Dental Double Sided Glass Photography mirrors feature a special coating to insure clear, sharp images of various regions of the mouth with either 35mm or digital cameras. Our special coating provides the highest and brightest reflectance ensuring excellent results.

UP TO 97% REFLECTIVITY

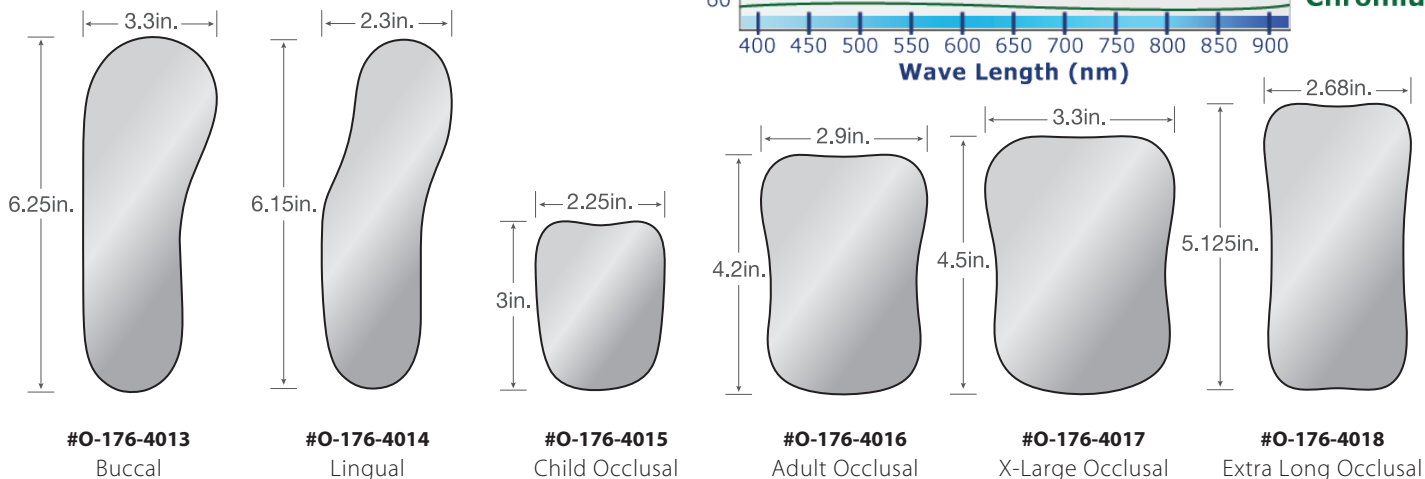
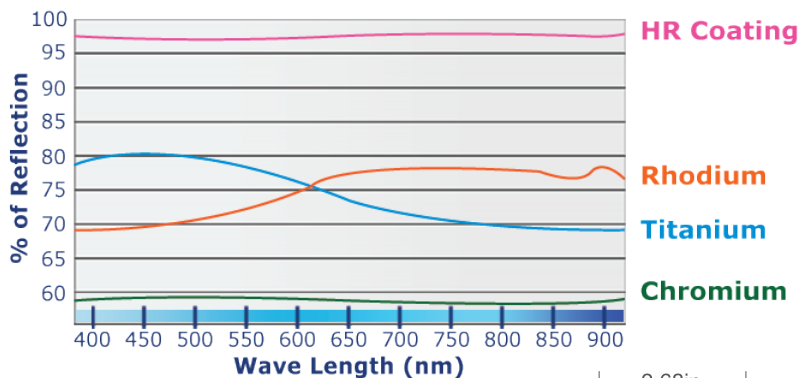

DynaFlex® Fog Free Intraoral Photo Mirror System

- Micro fan in base prevents fogging
- 3 L.E.D. lights provides direct lighting
- Interchangeable highly polished stainless steel mirrors with a special coating process
- Cordless – charger included
- 4" x 2.5" x 1" base serves as a handle during photography
- Battery Included
- 220 volt available upon request



DynaFlex® Fog Free Mirror System

Base, #3 Mirror, Charger, Barrier Sleeves
#176-4150

DynaFlex® Individual Fog Free Mirrors

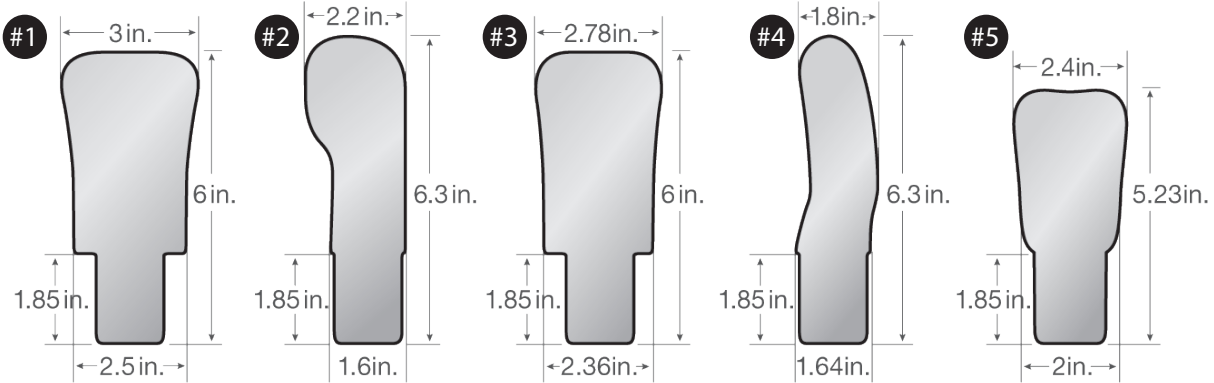

#O-176-4151 Occlusal Adult Large #1

#O-176-4152 Buccal Adult #2

#O-176-4153 Occlusal Adult Standard #3

#O-176-4154 Lingual Adult #4

#O-176-4155 Occlusal Child Large #5

#O-176-4157 Battery Only

#O-176-4156 FF Base w/ Micro Fan

#O-176-4158 Vinyl Covers For FF System. 20 Sheets

* #O-176-4156 battery is NOT included

Norris "Double Take" Mirror

Designed by Dr. Robert "Tito" Norris, this Double-Sided, multi-functional intraoral mirror allows the doctor to simultaneously retract and visualize groups of teeth. This unique design is particularly helpful when bonding second molars or bonding groups of anterior or posterior teeth. Its unique shape allows broader visualization of multiple bracket positions in relation to each other. Made from Medical-Grade Stainless Steel, each mirror can be sterilized through dry-heat or autoclave.

#216-5010 Double Take Mirror

#216-5011 Replacement Head



BACK VIEW

DynaFlex® *Exclusive*

HIGHEST QUALITY AVAILABLE

INSTRUMENTS



OLYMPUS

— INSTRUMENTS —

The Ultimate Orthodontic Instrument

DynaFlex® Olympus Pliers are made from the highest grade German Stainless-Steel bar stock available and hand formed to perfection. The finish is flawless and resists staining as well as corrosion. Our precision design incorporates a sliding lock that eliminates misaligned tips and a smooth, well-balanced fit. The exclusive Flush Screw Joint provides smooth action from day one without the risk of locking up or squeaking when used. The minute you hold one of these high-quality, perfectly formed instruments you will instantly feel and see an extremely well-made plier that will stand the test of time. As an added bonus, all of the inserts are made from super hard T-12 stainless steel that allows for very precise cuts that feel effortless and will not dull or fracture over time.



2 Year Warranty : Damage to instruments, due to normal everyday use, will be covered by DynaFlex® for one full year from the purchased date. After the 1 year period, DynaFlex® offers Renu Plier Repair Service, see page 154 for applicable fees.

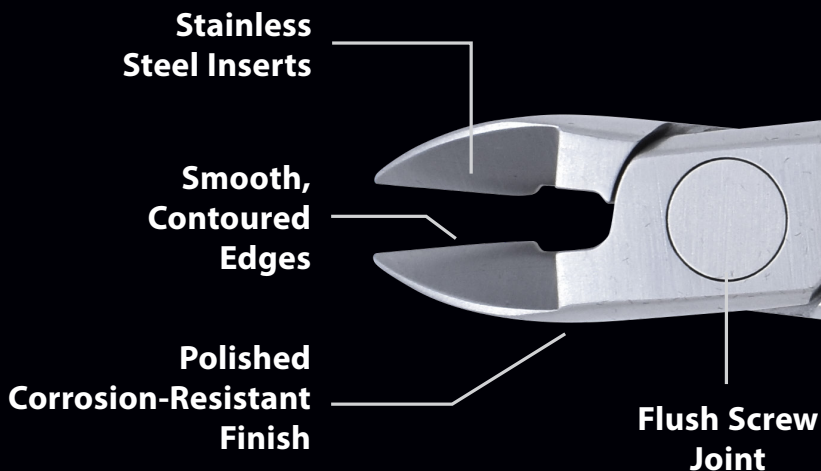

Olympus Orthodontic Instrument Sterilization Instructions

Instrument Sterilization:

Inspect, clean, and sterilize before each use. Use steam sterilize for at least 4 minutes at 270°F/132°C or 30 minutes at 250°F/121°C. Do not use the high pressure steam sterilization with the medicine made of alcoholic content. Use recommended chemicals only. Hinged instruments must be cleaned and sterilized in the open position. Clean instruments thoroughly, rinse and dry before sterilizing. Remove instruments immediately when cycle is complete to avoid possible signs of corrosion or discoloration.

Ultrasonic Cleaning:

Ultrasonic cleaning of cutting pliers is not recommended, this can dull or damage cutters. If ultrasonic cleaning is chosen, follow equipment manufacturer's recommended immersion schedule. Rinse instruments with high volume water before sterilizing. Air and towel dry instruments before sterilizing.

Lubrication:

To increase life of instruments, regular lubrication is recommended.

Always lubricate after sterilization.

One drop or a light spray is sufficient. Wipe off excessive lubricant. Sticky Joints is most common problem occurs due to less lubrication.

Sharpening:

Regular sharpening of orthodontic cutting pliers increase its life and ability to cut efficiently. Frequency of sharpening depends on: the frequency of use, as well as, the types and diameters of wires on which the cutter is being used. Check cutters frequently to assess if sharpening is needed.

Corrosion or Discoloration:

Even orthodontic instruments are made with highest quality surgical grade stainless steel which protect instruments from rust, but care is key factor for long life of instruments and protection from rust or oxidation. You can prevent corrosion problems by properly following all manufacturers recommendations. Discoloration of instruments, brown or yellow stains is the major cause if instruments are not dry after sterilization, not well cleaned or not kept in dry place. Discoloration may appear that may not be corrosion and can be removed by scrubbing with light wool saturate. Keep instruments in protective and dry case when not in use. It is recommended that a corroded instrument be replaced or through away. Never mix a corroded instrument with new instruments as oxidation may be spread to new instruments.

Olympus Hole Punch

Hole punch aligner plier, 5mm with standard handle.

#17-0010

Olympus Tear Drop

Teardrop punch with standard handle.

#17-0011

Olympus Horizontal

Horizontal punch with standard handle.

#17-0012

Olympus Vertical

Vertical punch with standard handle.

#17-0013

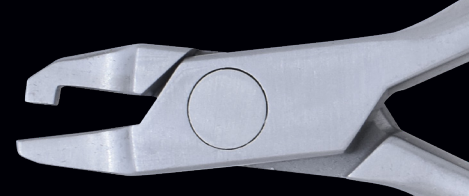
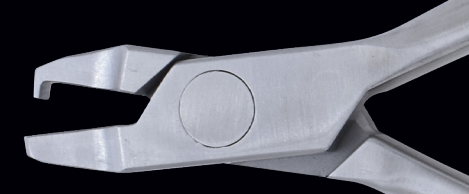
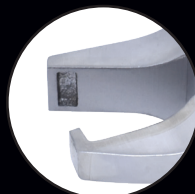
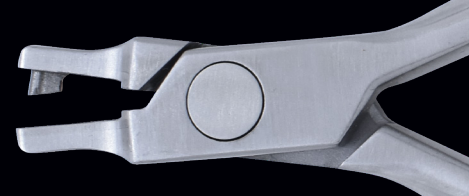

OLYMPUS

— INSTRUMENTS —



instruments



Olympus Pin & Ligature Cutter

Used to cut ligature wires up to .015". Standard handle.

#17-0014

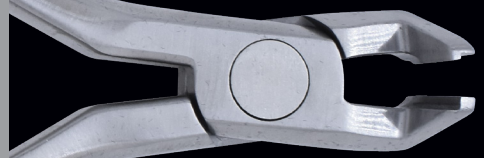

Olympus Distal End Cutter

Distal End Cutter, standard handle. Cuts wires from .014" to .022 x .025".

#17-0015



Olympus Flush Distal End Cutter

Flush Distal End Cutter, flush cut with hold, standard handle. Cuts wires from .014" to .022 x .025".

#17-0016



Olympus Hard Wire Cutter

Cuts NiTi, Australian and Stainless Steel wire up to .030". Standard handle.

#17-0018



Olympus Bracket Removing Plier

Straight tip, standard handle.

#17-0019



Olympus Posterior Bracket Removing Plier

Posterior band remover, standard beak, standard handle. Stainless steel tip.

#17-0020



OLYMPUS

— INSTRUMENTS —

Olympus Adhesive Removing Plier

Remove adhesive from teeth easily with this plier, standard handle. Plastic tip is cold sterilizable only.

#17-0021

Olympus Weingart Plier

Weingart utility Plier, standard handle. Bends wires up to .030".

#17-0022

Olympus How Plier

How Utility Plier used for grasping auxilliary attachments.

#17-0023

Olympus Three Prong Plier

Standard handle Three Prong Plier will bend wires up to .030".

#17-0024

Olympus Light Wire Plier

Used for bending wires of all types, up to .020", standard handle.

#17-0025

Olympus V Stop Plier

Used to make "V" bends in wires up to .030", standard handle.

#17-0026



OLYMPUS

— INSTRUMENTS —

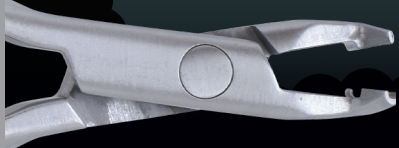

Olympus NiTi Cinch Back Premium

Long handle for easy gripping capability to bend distal end of NiTi wires.

#M-O610



Olympus NiTi Cinch Back Long Handle

Standard handle NiTi cinching plier. Securely bends NiTi behind the buccal tube without rolling wire.

#M-O610L

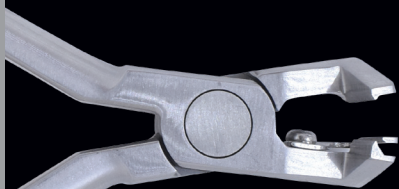

Olympus Distal End Flush Standard Handle

Flush cut standard size handle with standard size head. Cuts and holds round and rectangular archwires FLUSH to the tube. Wire cutting range .012" .022" Round up to .022" x .028" rectangle. Safety hold.

#M-O606



Olympus Distal End Flush Long Handle

Flush cut standard size handle with standard size head. Cuts and holds round and rectangular archwires FLUSH to the tube. Wire cutting range .012" .022" Round up to .022" x .028" rectangle. Safety hold.

#M-O606L

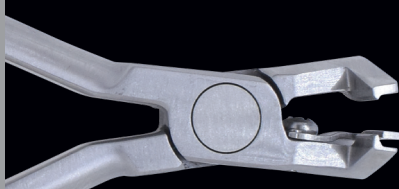

Olympus Distal Mini Flush Long Handle

Flush cut standard size handle with mini size head. Cuts and holds round and rectangular archwires FLUSH to the tube. Wire cutting range .012" .022" Round up to .019" x .025" rectangle. Safety hold.

#M-O606LM

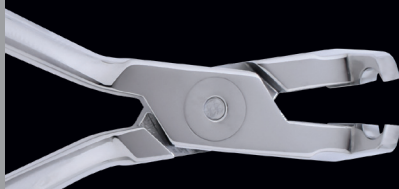

Olympus Direct Bond Bracket Remover Angulated

The 60° angle on the tips of this plier make for easy accessibility to the molar area.

#1604



Olympus Herbst Appliance Remover

Universally accepted as the #1 orthodontic instrument for removing herbst crown.

#M-D444

DynaFlex® Distal End Cutter w/Hold Flush Cut

Enables doctor to cut excess wire flush to the molar tube, leaving no protrusion of wire from behind the buccal tube. Safety hold feature holds cut wire and prevents wire from falling.

#1443



DynaFlex® Niti Distal Cinch Back

The simple one-step cinch back of nickel titanium archwires. The slim line design allows quick and easy bending of distal ends inside the mouth. No heat treating of wires is required. This provides maximum comfort for the patient as well as ease of use for the clinician.

- This universal plier can be used in any quadrant
- Features a cylindrical beak opposite concave-double sided
- Accepts all methods of sterilization

#O-224-3090



DynaFlex® De-Bonding Plier

- Forged of the highest grade surgical stainless steel
- Meticulously designed to handle easily

#O-224-3092

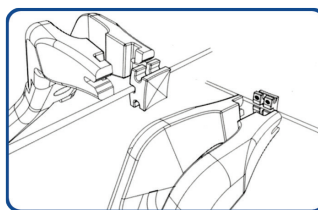

DynaFlex® Plier Brite Ultrasonic Solution

Plier Brite is a concentrated ultrasonic cleaning solution that cleans, shines and brightens pliers. Plier Brite contains superior anti-corrosive enzymes that prevent rust. Will brighten old, spotty pliers and keep new pliers clean and free from corrosion.

#M-PLIERBRITEQT



DynaFlex® Multi-Purpose Ultrasonic Solution Designed to be Gentle on Orthodontic Pliers

- Corrosion inhibitor insures safety of pliers & instruments
- Built-in lubricant keeps pliers in tip-top shape
- 40:1 concentrate 1 gallon makes 40 gallons of solution
- No rinse formula, go right from Ultrasonic into Sterilizer
- 1 Gallon Container

#O-155-5005





**Quality you can feel,
value you can depend on!**

DynaFlex® Legend™ Pliers are manufactured with a superior finish that resists staining and corrosion. Our precision design incorporates a sliding lock that eliminates misaligned tips and a handle design that features a sure grip with excellent balance.

All inserts are made from super hard T-12 stainless steel that allows clean wire cuts.

1 Year Warranty : Damage to instruments, due to normal everyday use, will be covered by DynaFlex® for one full year from the purchased date. After the 1 year period, DynaFlex® offers Renu Plier Repair Service, see PAGE 154 for applicable fees.

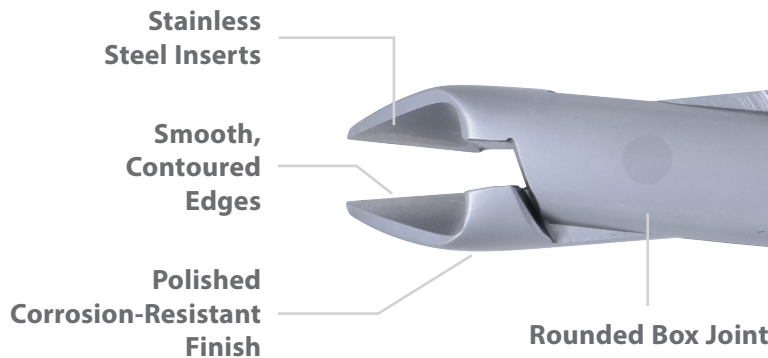

Orthodontic Instrument Sterilization Instructions

Instrument Sterilization:

Inspect, clean, and sterilize before each use. Use steam sterilize for at least 4 minutes at 270°F/132°C or 30 minutes at 250°F/121°C. Do not use the high pressure steam sterilization with the medicine made of alcoholic content.

- Use recommended chemicals only.
- Hinged instruments must be cleaned and sterilized in the open position.
- Clean instruments thoroughly, rinse and dry before sterilizing.
- Remove instruments immediately when cycle is complete to avoid possible signs of corrosion or discoloration.

Ultrasonic Cleaning:

Ultrasonic cleaning of cutting pliers is not recommended, this can dull or damage cutters. If ultrasonic cleaning is chosen, follow equipment manufacturer's recommended immersion schedule. Rinse instruments with high volume water before sterilizing. Air and towel dry instruments before sterilizing.

Lubrication:

To increase life of instruments, regular lubrication is recommended.

- Always lubricate after sterilization.
- One drop or a light spray is sufficient.
- Wipe off excessive lubricant.
- Sticky Joints is most common problem occurs due to less lubrication.

Sharpening:

Regular sharpening of orthodontic cutting pliers increase its life and ability to cut efficiently. Frequency of sharpening depends on: the frequency of use, as well as, the types and diameters of wires on which the cutter is being used. Check cutters frequently to assess if sharpening is needed.

Corrosion or Discoloration:

Even orthodontic instruments are made with highest quality surgical grade stainless steel which protect instruments from rust, but care is key factor for long life of instruments and protection from rust or oxidation. You can prevent corrosion problems by properly following all manufacturers recommendations. Discoloration of instruments, brown or yellow stains is the major cause if instruments are not dry after sterilization, not well cleaned or not kept in dry place. Discoloration may appear that may not be corrosion and can be removed by scrubbing with light wool saturate. Keep instruments in protective and dry case when not in use. It is recommended that a corroded instrument be replaced or through away. Never mix a corroded instrument with new instruments as oxidation may be spread to new instruments.

Legend II Aligner - Hole Punch

Hole punch, .5mm with standard handle.

#17-3010



Legend II Aligner - Tear Drop

Teardrop punch with standard handle.

#17-3011



Legend II Aligner - Horizontal

Horizontal punch with standard handle.

#17-3012



Legend II Aligner - Vertical

Vertical punch with standard handle.

#17-3013



Legend II Micro Pin & Lig Cutter 15° Angle

Micro small head Pin and Ligature Cutter with 15 degree angle. Standard handle.

Cuts wires up to .015"

#17-3015

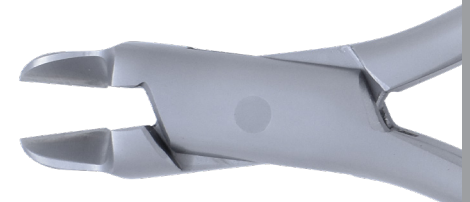

Legend II Pin & Ligature Cutter

Straight Pin and Ligature Cutter, standard handle. Cuts wires up to .015"

#17-3016

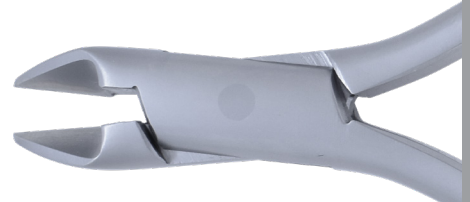



Legend II Hard Wire Cutter

Straight jaw hard wire cutter, standard handle. Cuts wires up to .022 x .025".

#17-3017



Legend II Flush Cut Distal End Cutter w/ Safety Hold

Flush cut Distal End Cutter with hold, standard handle. Cuts wires from .014" to .021 x .025".

#17-3018

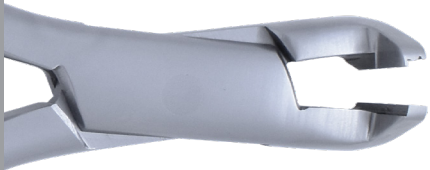

Legend II Long Handle Distal End Cutter w/ Safety Hold

Long handle distal end cutter with hold. Long handle. Cuts wires from .014" to .021 x .025".

#17-3019



Legend II Weingart Plier

Weingart utility plier, standard handle. Bends wires up to .030".

#17-3020



Legend II Posterior Band Remover Pliers

Posterior Band Remover, standard beak, standard handle. Diameter of pad 6.35mm. Replacement pads are heat sterilizable.

#17-3021



Legend II Bracket Removing Pliers

Bracket and adhesive removing pliers, standard handle. Diameter of pad 6.35mm. Replacement pads are heat sterilizable.

#17-3022



LEGEND II

ORTHODONTIC INSTRUMENTS

*Quality you can feel,
value you can depend on!*

Legend II Adhesive Removing Pliers

Adhesive Removing Pliers with standard handle. Diameter of pad 6.35mm. Replacement pads are heat sterilizable.

#17-3023

Legend II Bird Beak Pliers

Bird Beak Pliers with standard handle. Bends wires up to .030". Beak size measures .035".

#17-3024

Legend II Step Plier 1mm

1mm Step Plier with standard handle. Bends wires up to .020".

#17-3025

Legend II Crimpable Ball Hook

Ball Hook Crimping Pliers with standard handle. Hooks insert into plier tip and are then easily crimped on the archwire.

#17-3026

Legend II Torquing Plier Set (Male/Female)

Male and Female Torquing Plier Set, standard handle. Torques wires up to size .021" x .025".

#17-3027

Legend II Optical Plier

Optical Pliers with standard handle. Bends wires up to .030".

#17-3028

Legend II Three Prong Plier

Three Prong Pliers with standard handle. Bends wires up to .030".

#17-3029

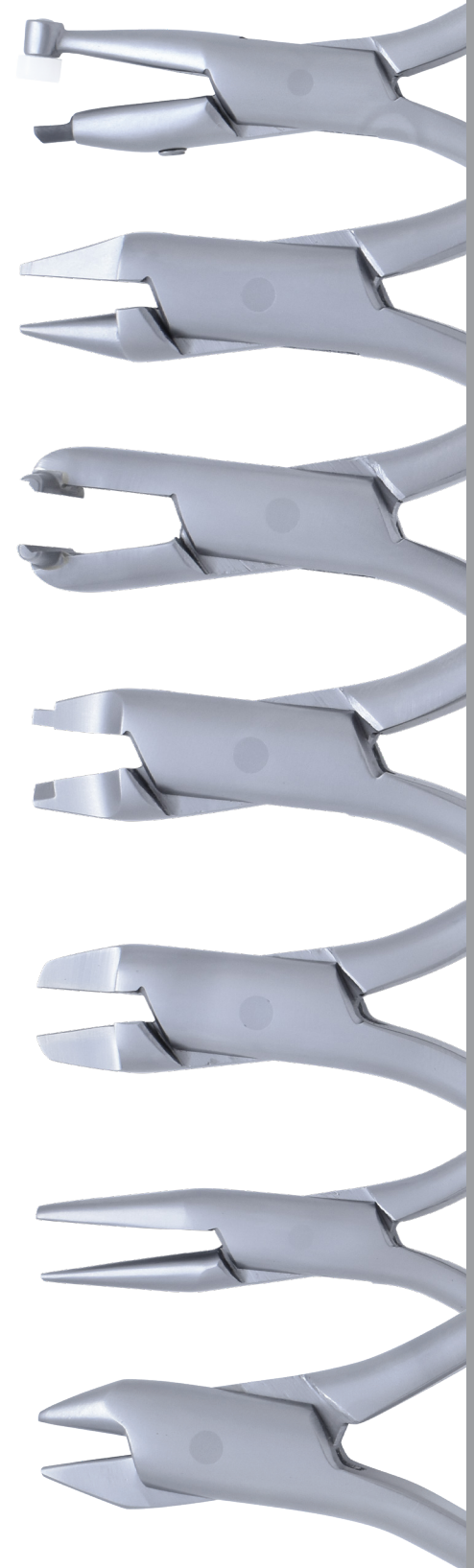

instruments

DynaFlex® Mathieu Forcep Stainless Steel

Our Mathieu forceps are made from the highest grade stainless steel available for instrument manufacturing. Exceptionally smooth operating and extremely precise tips makes our Mathieu forceps the premier instrument available today. You won't find a better value than our Mathieu forceps and most orthodontic companies charge three times our price for a lesser quality instrument. Guaranteed to outperform all others.

#1400-0255S Narrow Satin Finish

Best Seller



Satin Finish

Single Spring Design



DynaFlex® Round Plier Rack with Holding Tube

Outer ring of this round rack holds pliers, while the inner tube is great for holding hand instruments or straight wire. Rack dimensions are: 4" diameter x 4-1/4" high. Center holding tube diameter measures 1-1/4".

#1486



DynaFlex® Round Plier Rack

Clear plastic rack is ideal for holding pliers and cutters. Rack dimensions are: 4" diameter x 4-1/4" high

#1487



DynaFlex® Upright Plier Rack

Outer ring of this round rack holds pliers, while the inner tube is great for holding hand instruments or straight wire. Rack dimensions are: 4" diameter x 4-1/4" high. Center holding tube diameter measures 1-1/4".

#1488



DynaFlex® Convertible Cap Remover

For use in removing the Convertible Cap on a Convertible Molar Bracket when necessary.

#1610 Convertible Cap Remover

#1610-R Replacement Blade

#1610-S Replacement Screw

#1610-W Allen Wrench

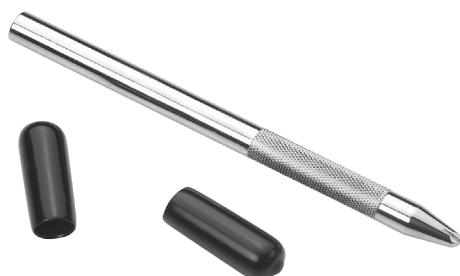

DynaFlex® Polar Bear Instrument

A great little tool for turning Niti wire soft and flexible. Slotted end to effectively push Niti wire into bracket slot on cases which are difficult to ligate. Designed for use intraorally. Simply fill the instrument with water, cap and freeze.

#1470

DynaFlex® Stainless Steel Hand Instruments

These hand instruments are manufactured with high grade stainless steel and feature accuracy in each tip. Guaranteed not to rust or corrode. Sold individually.



#1429 Double Ended Lig Director



#1400-833 Small Ligature Director/Scaler



#1400-030 Scaler/Band Pusher



#1444 Self-Ligating Instrument

DynaFlex® Zeffiro™ Stainless Steel Hand Instruments

Super high quality hand instruments have a patented handle system that reduces bacterial residue that usually hides on grid type instruments. Extremely lightweight with a slightly larger handle makes these instruments feel more comfortable to your hand with better tactile control.

#1400-50



DynaFlex® Premium Scalers

Made by a leading US instrument company, these hand instruments will provide you with the quality you expect and the comfort you deserve. A great value for your purchasing dollars!



#1400-4839 Scaler LT H6H7



#1400-4843 Scaler LT U15/33



DynaFlex® Bracket Tweezer - Stainless Steel

Made from high-grade stainless steel. Reverse action holds bracket firmly. Serrated tips provide good gripping action.

#1418



DynaFlex® Posterior Bracket Tweezer Long Handled

The same small tip as our regular posterior bracket tweezer with an extended handle to enable an easier reach to the posterior region. Overall length is 5-1/4".

#1416



DynaFlex® Posterior Bracket Tweezer - Small

Similar to our standard bracket tweezer but with smaller, angulated beaks allowing for more visibility when placing brackets. Reverse-action provides for ease in loading and firm grip. Overall length is 4 1/2".

#1417



DynaFlex® Bracket Placement Instrument

This bracket placing instrument is like having 2 instruments in one. A reverse action bracket tweezer at one end and a bracket positioning tool at the other end will eliminate the need for two instruments.

#1417-15



DynaFlex® College Pliers - Stainless Steel

Made from high-grade stainless steel. Non-locking pliers with serrated tips.

#1415



DynaFlex® Multi-Task™ Tweezer

Place, position & clean a bracket with ONE Instrument!

#O-600-1003



Place Bracket



Serrated End Fits in Slot to Position Bracket



Clean Residual Composite Around Bracket



DynaFlex® Curved Direct Bond Instrument

- Designed to securely hold and place lingual brackets or attachments.
- Works great with Habit Control Device, Bite Openers and placement of molar tubes.

#O-600-1018

DynaFlex® Buccal Tube Instrument

Don't miss out on the convenience of this product! This instrument makes placing molar brackets much easier than ever before! The instrument has a very slender tip that inserts easily into the slot on the molar bracket. The reverse-action tweezer allows for precise and easy placement of the molar bracket.



#1400-676



DynaFlex® College Pliers

#O-220-3050 Self-Locking

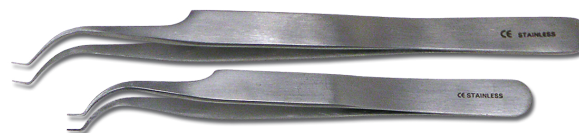

DynaFlex® Keat Tube Placing Tweezers

#O-600-1012 4.5" Regular

#O-600-1014 5.5" Long Handle

DynaFlex® Distal Bender

This simple new tool will make cinch back bends a snap. Features a long handle with an angle tube. Simply slip the tube over the archwire and bend distal to the buccal tube to create a cinch back bend. Fits wire up to .019x.025.

#1407

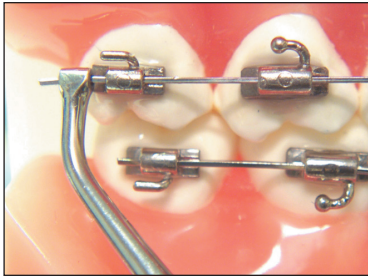

DynaFlex® Heavy Duty Band Pusher

Easy to hold handle allows for increased control in pushing and seating bands.

#1420



DynaFlex® 3.25" Crown & Bridge Scissors

For precise Essix® appliance trimming. Especially helpful for trimming the lingual on Glacier® & Essix® appliances.

#O-220-1016



DynaFlex® 5.5" Mayo Scissors

Used to cut the labial on our line of Glacier® & Essix® appliances.

#O-220-1015



DynaFlex® Spee Scissor

Ideal for all your bleaching, invisible retainers, and fluorine tray needs. The curve cutting blade makes it easy to contour the anterior lingual area.

#O-220-1018

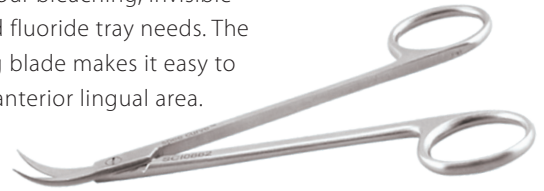

DynaFlex® Hemostat - Stainless Steel

Made from high-grade stainless steel. Easy to use and reliable. 3 tip designs to choose from.

#1400-018 Hook Tip

#1400-014 Without Hook Tip

#1400-016 Curved Hemostat



Need Help Placing Your Order?

Our highly trained and skilled Customer Care Team is here to assist you with any questions you may have.

Call **866-346-5665** or Chat Live online at **www.dynaflex.com/order**



Does your office have pliers that need to be
repaired, sharpened or re-tipped?

Renu™

Instrument Repair Service

BEFORE

AFTER

DynaFlex® is proud to offer Renu™, a quality instrument repair service that is both economical and reliable. Most repairs will be returned back to you complete in about 10-14 business days. However, pliers or instruments that need extra attention may take 2-3 weeks.

Simply Mail Your Instruments To:

DynaFlex®
ATTN: Renu™
8050 Hawk Ridge Trail
Lake St. Louis, MO 63367

Make sure to include the doctor's name, address and phone number. We recommend using a carrier with tracking capabilities.

Service
Sharpen Cutters
Sharpen Band & Bracket Remover
Retip Bird Beak
Retip Cutter
Retip Band & Bracket Remover
Retip Scalers, Hand Instruments, Explorers
Mathieu Spring Replacement
Sharpen Scalers
Repair Hemostat, Serrated Needle
Miscellaneous Repair
Repair Scissors
Repair Mathieu Forceps
Repair Utility Pliers
Replace Screw
Replace Hand Instrument Handle
Replace Rests
Repair Bird Beak Pliers
Retip 3 Prong Plier
Re-Tip Utility Pliers
Handpiece

*Prices are estimates only and may vary depending on work required to repair or sharpen.

DynaFlex® Boone Bracket Gauge

Place gauge on the incisal/occlusal surface of tooth to simplify bracket positioning. Solid stainless steel for lasting durability! Measures 3.5mm, 4.0mm, 4.5mm and 5.0mm.

#1324

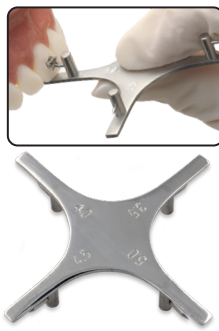

DynaFlex® Boone Combo Gauge & Marker

Convenient gauge and marker together. Replaceable graphite also included.

#O-600-1021

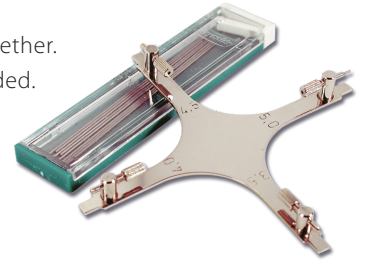

DynaFlex® Metal Spatula

Flexible blade and easy-grip handle provides ease and control in mixing. Stainless steel construction for durability.

#1405



DynaFlex® Handheld Prophy Instrument

Cleaning a single tooth at a time will save staff time and decrease wear and tear on your handpiece. Made of high-quality stainless steel that will not rust. Instrument requires screw-type prophy cups.

#1402



DynaFlex® Boley Gauge

Boley Gauge, manufactured of high grade stainless steel, used for accurate millimeter measurements of thickness, length and width in either a laboratory setting or your clinic.

#1480

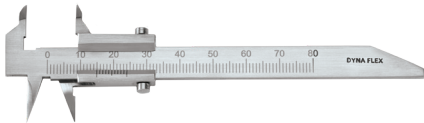

DynaFlex® Prophy Cup Holder

Autoclavable and disposable prophy cup holders are convenient to use. Disposable cup holder is sold 25 cups and handles per package.

#1402-05



DynaFlex® Colored Disposable Mouth Mirrors

Brilliantly colored handles with an ergonomic design will not only brighten the office but give you comfort with every use. Our highly reflective mirror gives you a great intraoral view and comes with a peel away seal for a clean and clear view with each mirror. All of these benefits plus an economical price is all the reason you need to call today! Pack of 24.

ITEM #	COLOR
#4900-B	Blue
#4900-GN	Neon Green
#4900-PK	Pink
#4900-P	Purple
#4900-W	White



DynaFlex® Stainless Steel Mouth Mirrors

An affordable high quality mouth mirror is now available! Made of high grade stainless steel, these mirrors and handles will not rust or corrode. Sterilizable by any method. Mirrors are available in size 4 or 5.

#1479-10 Size 4 Mirror

#1479-20 Size 5 Mirror



DynaFlex® Replacement Mirrors

These replacement mirrors fit our DynaFlex® Stainless Steel Mouth Mirrors. Replacement Mirrors come in packs of 5.

#1479-4 Size 4

#1479-5 Size 5



DynaFlex® Mouth Mirrors - Disposable

Disposable front surface mirrors are sturdy, economical mirror with a clear reflection. White. Pack of 100.

#O-220-2016



INTERPROXIMAL REDUCTION



DynaFlex® Diamond Disc



#O-109-1300

Single-Sided: 7/8" dia. 0.10 mm thick

#O-109-1302

Double-Sided: 7/8" dia. 0.15 mm thick

DynaFlex® See Thru Diamond Disc

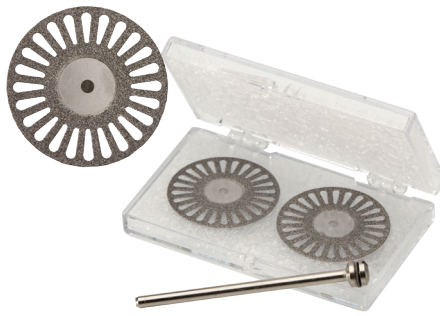

#O-109-1303

Double Sided: 7/8" dia. 0.18 mm thick.

Smooth Interproximal Stripping

DynaFlex® Serrated Diamond Disc



Enlarged To Show Detail

#O-109-1299

Double Sided: 7/8" dia. 0.20 mm thick.

Smooth Interproximal Stripping

DynaFlex® Interproximal Disc

A double sided diamond disc designed for separating and shaping the interproximal, marginal and facial surfaces of enamel or composite, acrylic and ceramic restorations. Discs are electro plated and riveted to maintain a long instrument life. Comes attached to mandrel. Honeycomb swirl allows for more tooth contact. Thickness of discs is 0.18mm. Sterilization recommendation: 30 min at 121 degrees C or for 4 minutes at 134 degrees C.



- #0778** Honeycomb 22mm
- #0778-01** Honeycomb 18mm
- #0778-02** Honeycomb 14mm

- #0779** Honeycomb Swirl 22mm
- #0779-01** Honeycomb Swirl 18mm

DynaFlex® Ortho Stripping Disc

A double sided disc used for smooth interproximal stripping. Extremely flexible and easy to use. For use with the low speed handpiece. Disc thickness is 0.14mm. Available in 22mm or 16mm diameter.



- #0760** 22mm Diameter
- #0760-01** 16mm Diameter

STERILIZATION RECOMMENDATION:
Rinse with water and dry, then steam sterilize at 121° C for 20 min or 134° C for 5 min.

DynaFlex® Disc Guard Set

Protects patient from stripping discs. Allows you to provide extra patient safety. Fits 7/8" discs. Kit includes shaft, 22mm guard, 16mm guard and 8mm guard.

#0761

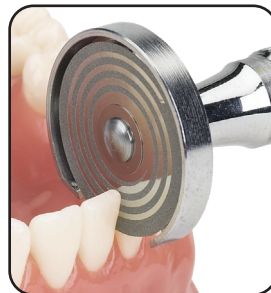

DynaFlex® ContacEz® Thickness Gauge Set

Incremental thickness gauge made of stainless steel. Set of 6 guides, one each size: 0.10mm, 0.20mm, 0.25mm, 0.30mm, 0.40mm, .0.50mm.

#O-109-1525



DynaFlex® ContacEZ® IPR System

The ContacEZ IPR System is an innovative interproximal enamel reduction system that makes IPR safer and more accurate without cutting excessive enamel.

- Will not cut lips or gums and eliminates gagging
- Flexible strip does not create corners or subgingival ledges
- Single-handed design offers optimal tactile control
- Effective for anterior teeth, easy to access to posterior areas, and case refinement.

STERILIZATION RECOMMENDATION:

Do not heat sterilize.
Steam sterilization only, up to 270° F at 30 psi max.



Kits

#O-109-1500 Starter Kit (4 each : Yellow, Red, Green, Dark Blue)

#O-109-1501 Full Kit (8 each: Yellow, Red, Green, Dark Blue)

Individual Refill Strips

ITEM #	COLOR	SIZE	FUNCTION	DOUBLE /SINGLE SIDED	GRIT
#O-109-1502	Yellow	.06mm	Starter	Single Sided	Extra Fine
#O-109-1506	Clear	.10mm	Single Sided Opener	Single Sided	Medium Fine
#O-109-1503	Red	.012mm	Opener	Double Sided	Medium
#O-109-1505	Dark Blue	.015mm	Widener	Double Sided	Coarse
#O-109-1504	Green	.020mm	Extra Widener	Double Sided	Coarse

GLACIER®

Ultra Premium Thermoform Material

For Fabrication of Aligners & Retainers

- Durable
- Superior Clarity
- Grab-Force Technology
- Enhanced Tooth Movement
- Box of 100
- Made In The USA

Available In:
.030, .035 & .040
125mm Round &
5"x 5" Square

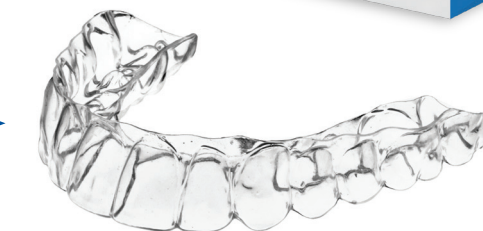
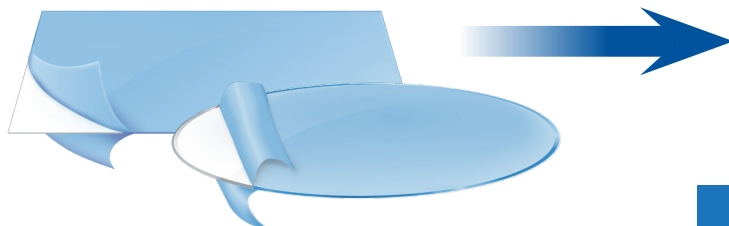

See Page 10 For More Information



DynaFlex® Dome® Manual Stripping Handle

A useful tool for opening tight contacts between teeth and contouring. Light-weight plastic handle. Handle sold individually. Tips sold separately below.

#0716



DynaFlex® Replacement Heads for Dome® Manual Stripping Handle

Cold sterile only. Pack of 4

ITEM #	SINGLE/DOUBLE SIDED	GRIT
#0714-011	Double Sided	Coarse
#0714-012	Double Sided	Med.
#0714-014L	Single Sided - Left	Med.
#0714-014R	Single Sided - Right	Med.
#0714-013L	Single Sided - Left	Coarse
#0714-013R	Single Sided - Right	Coarse

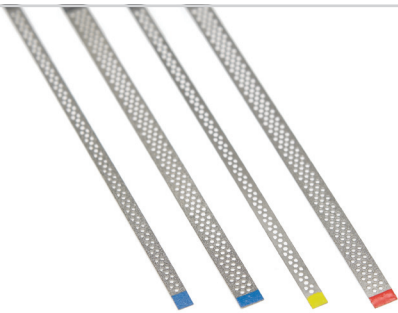

DynaFlex® Interproximal Stripping Strips

A meshed, strip for interproximal reduction, contouring and finishing most surfaces. Strips are available in 2.5 or 3.75 width and medium, fine and extra fine grit. Single Sided. Sold individually or in bulk packs of 10.

STERILIZATION RECOMMENDATION:
Autoclave 30 min at 121° C
or 4 minutes at 134° C

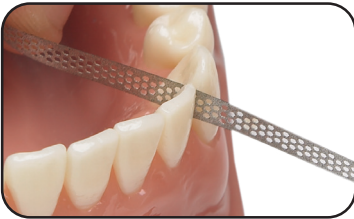

GRIT	COLOR CODE	SIZE	SINGLE PACK	10 PACK
Extra Fine	Yellow	2.5	#1013	#1013-B
Extra Fine	Yellow	3.75	#1013-15	#1013-15B
Fine	Red	2.5	#1013-11	#1013-11B
Fine	Red	3.75	#1013-14	#1013-14B
Medium	Blue	2.5	#1013-12	#1013-12B
Medium	Blue	3.75	#1013-13	#1013-13B



DynaFlex® Lightning Strips

Thin metal strips for interproximal reduction, contouring and finishing enamel, metallic and composite surfaces. Manufactured from 304 Stainless Steel. Strips are .003" thick. Available in single or double-sided surfaces. 6mm or 8mm widths available. 6" long. Pack of 10.

STERILIZATION RECOMMENDATION:
Steam autoclave with the following parameters: 134 degrees C, 2.5 minutes, 10 minute drying time.

Single Sided Lightning Strips

ITEM #	SIZE
#1012-01	Fine (6mm)
#1012-02	Medium (6mm)
#1012-04	Coarse (6mm)
#1013-02	Medium (8mm)
#1013-04	Coarse (8mm)

Double Sided Lightning Strips

ITEM #	SIZE
#1012-03	Medium (6mm)
#1013-03	Medium (8mm)



DynaFlex® Reciprocating Contra Angle

- Fits 'E' type handpieces
- 1.4 mm stroke
- Autoclavable
- Optimal torque

#O-109-1600

*Heads Sold Separately



DynaFlex® Reciprocating IPR System

A safe, precise and reliable method to achieve accurate interproximal stripping. More controllable and safer for the dentist and patient than diamond discs. Provides the flexibility that diamond and carbide burs can't. Faster and more comfortable for the patient than manual hand stripping. Maximum speed 20,000 oscillations per minute.

Double Sided Available in 5 different grits

- 90 micron - for use as a saw for opening contacts
- 60 micron - for reduction
- 40 micron - for contouring
- 25 micron - for finishing
- 15 micron - for pre polishing



W/ HOLES	#O-109-1605H	#O-109-1606H	#O-109-1607H	#O-109-1608H	#O-109-1609H
GRIT	15 micron/Extra Fine	25 micron/Fine	40 micron/Medium	60 micron/Coarse	90 micron/Extra Coarse

DynaFlex® Single Sided

Available In 5 Different Grits / Right And Left

- 90 micron - for use as a saw for opening contacts
- 60 micron - for reduction
- 40 micron - for reduction and contouring
- 25 micron - for finishing
- 15 micron - for pre polishing



LEFT W/ HOLES	#O-109-1620H	#O-109-1622H	#O-109-1624H	#O-109-1626H	#O-109-1627H
GRIT	15 micron	25 micron	40 micron	60 micron	90 micron
	Extra Fine	Fine	Medium	Coarse	Extra Coarse



RIGHT W/ HOLES	#O-109-1628H	#O-109-1630H	#O-109-1632H	#O-109-1634H	#O-109-1635H
GRIT	15 micron	25 micron	40 micron	60 micron	90 micron
	Extra Fine	Fine	Medium	Coarse	Extra Coarse

MISCELLANEOUS



DynaFlex® Retainer Cases - 20 Pack

Brightly colored, scented, splash, sparkle or plain retainer cases are sure to be a hit with your patients! Name tags included. 20 per pack. Large quantity discounts available.

CUSTOM IMPRINTING AVAILABLE!

A great and inexpensive marketing tool!
See Page 168 For Details
Available for 0854 & 0859 Series



#0854-AQ
Aqua



#0854-BB
Blueberry



#0854-BG
Bubble Gum



#0854-BL
Black



#0854-C
Cherry



#0854-F
Fuchsia



#0854-G
Grape



#0854-GY
Grey

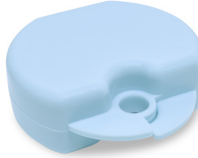

#0854-LB
Light Blue



#0854-M
Mint



#0854-MR
Maroon



#0854-O
Orange



#0854-TB
Sparkle Tropical Blue



#0854-W
White



#0854-Y
Banana

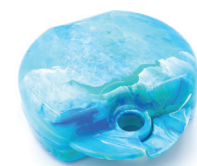

#0854-21
Under The Sea Splash

DynaFlex® Flip Top Retainer Cases - 12 Pack

Easy open flip up lid makes this retainer case a favorite for everyone. Available in 9 bright beautiful colors. Box measures 3" W x 2-1/2" L x 1" H. Packed in boxes of 12 with patient labels.



#0856-BK
Black



#0856-B
Blue



#0856-NG
Neon Green



#0856-NP
Neon Pink



#0856-NT
Neon Tangerine



#0856-NY
Neon Yellow



#0856-P
Purple



#0856-R
Red



#0856-W
White

DynaFlex® Mini Retainer Cases - 20 Pack

Brightly colored and durable for every day use. Our new small retainer cases measure 2.75" W x 2.5" L x 3/4" deep and are available in a variety of colors and/or scents. Your patients will approve! 20 per package.



#0859-AQ
Aqua



#0859-BL
Black



#0859-F
Fuchsia



#0859-G
Grape



#0859-GY
Grey



#0859-LB
Light Blue



#0859-M
Mint



#0859-MR
Maroon



#0859-O
Orange



#0859-W
White



#0859-Y
Banana

DynaFlex® Retainer Brite

Cleaning tablets to keep retainers fresh and looking new. Fresh minty taste. Will not dull or corrode appliance. Available in 36 or 92 count packages.

#0858 (36 count)

#0859 (92 count)

#M-RETBRT100 Retainer Brite Trial (100pk pouches)

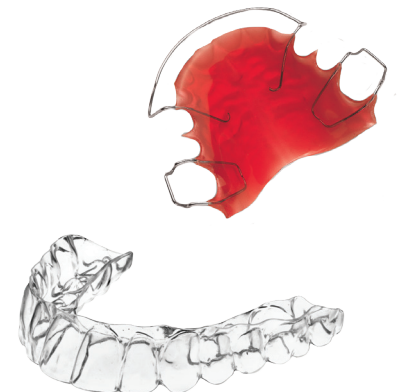

Great For Clear Aligners



DynaFlex® Bracket Wax

Clear bracket relief wax. Easy to use compacts. 50 per box.

#1300



DynaFlex® Wax Dispenser

Keep your office looking organized with the DynaFlex® Wax Dispenser.

#1499

DynaFlex® Wax Boxes

Reduces patient discomfort. Plain, tropical, splash or scented wax boxes will be a hit with your patients! Each compact contains clear bracket wax. 50 compacts per box.



#1309-AQ
Aqua



#1309-BB
Blueberry



#1309-BG
Bubble Gum



#1309-C
Cherry



#1309-G
Grape



#1309-LB
Light Blue



#1309-M
Mint



#1309-MR
Maroon

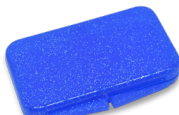

#1309-TB
Tropical Blue



#1309-TG
Tropical Green



#1309-TP
Tropical Pink

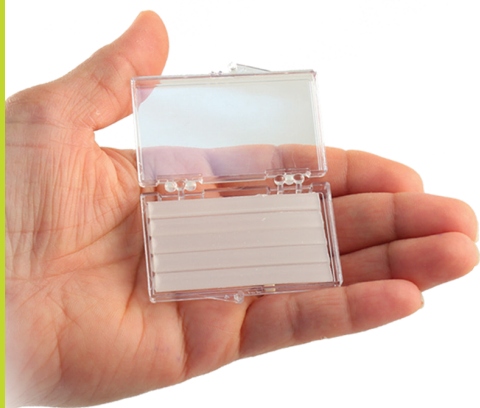

DynaFlex® Bracket Wax

Wax Packs Relieves Irritation From Sharp Wires

- Available filled with wax or empty compacts.
- Save emergency visits!
- Wax blends in with teeth for low visibility.
- 5 unflavored wax strips in a crystal clear box.
- Adheres to orthodontic appliances to help relieve irritated tissue.
- Box of 100

#O-100-1066



DynaFlex® Pontic Wax: Tooth Colored

Creates the appearance of teeth inside aligners with areas of missing teeth/tooth. Easy to apply and remove when needed. If the pontic wax wears down during treatment it can easily be replaced by the patient in between appointments. Contains 25 cases.

#O-101-1062



DynaFlex® Brace Gard™ Silicone Brace Wax Squares

Now in 12 easy to use, pre-measured squares. Less patient handling, more sanitary. Mirror included for easy application. 5 brightly colored boxes. 80 per package.

#1319



DynaFlex® Magic Touch Antiseptic Gel Only

A very healing Antiseptic/Anesthetic Gel that effectively toughens healed tissue helping to condition newly bonded patients. The astringent value of the natural ingredient, Myrrh, offers excellent healing of sore soft tissue due to braces and also mouth ulcers. Each tube is 1/8-ounce.

#1320-10 Magic Touch Orthodontic Gel (Bulk Pack - 72)

#1320-500 Magic Touch Dispenser Series (144/pk)



DynaFlex® Brace Gard Silicone Silicone Brace Wax Squares

Special food grade silicone wax that will not melt or become hard and crumbly. Transparent for a pleasing appearance and remains pliable allowing the patient to remove and reapply. Dispenser pack of 200. 2 rods per pack.

#O-100-1073



DynaFlex® Lip Protectors

Perfect For Patients Who Play Musical Instruments

Tiny bur-free fingers grip the archwire between the brackets. Long enough to cover an entire 5 to 5 prescription as well as buccal tubes. Comes in pairs of upper & lower. Set of 2.

#O-100-1090

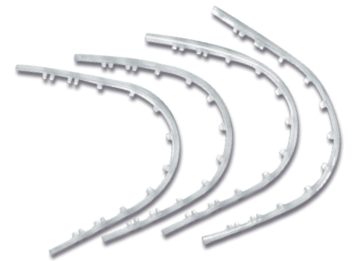

DynaFlex® Comfort Covers™: For Orthodontic Braces

Shields the patient's lips and cheeks from the discomfort often associated with orthodontic treatment or activities where risk of oral lacerations could occur. 5 sets per package.

#O-100-1088



Champion™ Comfort Covers

The Champion Comfort Cover is designed to provide an easily installed shield that bumpers lips and cheeks from discomfort. Manufactured of soft pliable medical grade PVC. C-shaped design simply clamps over the braces. 5 one-foot lengths per pack.

#1160-1 Clear

#1161-FB Fluorescent Blue

#1161-FG Fluorescent Green

#1161-FR Fluorescent Red

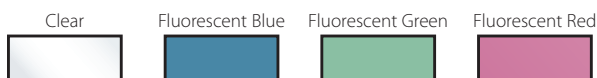

Custom Imprinting Services

Personalized Retainer Cases & Wax Boxes - Ink Stamped

High quality retainer cases and wax boxes fully customized with your logo.

Simply place your order online, with your local rep, or by calling 866-346-5665.

- Choose your imprint/ink color, retainer case/wax box colors, then select a quantity.
- E-mail your logo file to imprints@dynaflex.com, you'll then receive a proof for approval.
- Once approval is received, production on your personalized retainer cases or wax boxes will begin!



Personalized Wax Box With White Ink

DynaFlex® Personalized Wax Boxes

See **PAGE 164** for color options. Price includes wax box with imprint. **100 unit minimum order.**

A great and *inexpensive* marketing tool!



Personalized Retainer Case With Black Ink

DynaFlex® Personalized Retainer Cases

Available on the 0854 and 0859 series. See **PAGE 164-165** for color options. Price includes retainer case with imprint. **100 unit minimum order.**

DynaFlex® Personalized Bracket Wax Packs: Hot Foil Stamped

FREE One-Time Artwork

FREE One-Time Setup

FREE One-Time Impression Plate

High quality wax packs fully customized with your name, number, and/or message. A great & inexpensive marketing tool. Our crystal clear box is hot stamped with a beautiful foil that reflects the same quality and care your office does. The patient wax packs are available in boxes of 100, each pack containing 5 wax strips. Each pack personalized with your practice name, phone number and your message. Box of 100.

#O-100-1063 Personalized with Gold Foil Print

#O-100-1064 Personalized with Red Foil Print

#O-100-1065 Personalized with Blue Foil Print



Patient Home Care & Travel Kit For Orthodontic Patients

*Personalized Shown

The Right Stuff Kit consists of an impact resistant, translucent blue case containing the most commonly used ortho patient care items.

An easy and convenient way for your patients to maintain dental hygiene as well as their new appliances between visits. The Travel Case keeps the contents clean and intact so they're always ready whenever and wherever your patients need them.



Each Right Stuff™ Kit Includes

- Ortho Wax Pack
- Dental Mouth Mirror
- Proxi Brush With Cover
- Ortho Appliance Care Instructions
- Floss Threaders
- Johnson & Johnson 5 Yard Waxed Floss
- Home Use V Trim Toothbrush
- Travel V Trim Toothbrush



Non-Personalized The Right Stuff™ Kits No Minimum

#O-100-1002

Personalized The Right Stuff™ Kits 100 Kit Minimum

Get your personalization form online or by phone.

Ortho Care™ Orthodontic Home Hygiene Kit

The Ortho Care Home Hygiene Kit gives the orthodontic patient all the tools to properly maintain their appliances. The handy, durable, pouch keeps everything in one place for the patient on the go.

#O-100-1009

Each Ortho Care™ Kit Includes

- 12 yards Dental Floss
- 10 Floss Threaders
- Patient Emergency Wax Pack
- V Trim Orthodontic Toothbrush
- V Trim Travel Orthodontic Toothbrush
- Proxi Brush
- Mouth Mirror
- 2 Minute Timer



miscellaneous



DynaFlex® Eez-thru® Floss Threader

Versatile nylon loop designed to help patients in threading dental floss under bridges, splints or orthodontic appliances. 5 per envelope. Box of 100.

#O-100-1126



The DynaFlex® Platypus Orthodontic Flosser

The easiest way to floss with braces! The Platypus Flosser has changed the way the world flosses with braces! So easy to use you can floss at school, in the car, wherever you are!

#0800-150 Pack of 30

#0800-151 Bulk Pack - 75 Bags of 3



Reach® Floss - Easy Slide®

- Patient trial size
- 5 yards (4.6m)
- Ultra shed resistant floss
- Box of 144

#O-100-1128

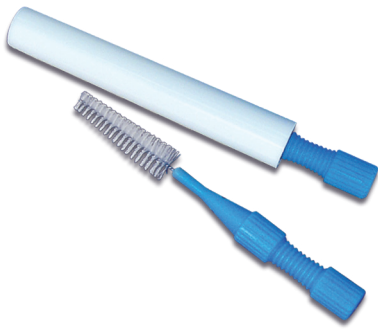

DynaFlex® Tapered Proxi Brush: With Cover

For fast, efficient removal of plaque and food particles from braces and other appliances. The Proxi Brush bristles reach into and clean the indents on the surfaces between the teeth & braces. Great for use in between brushes. Includes a convenient cover for on the go use.

#O-100-1120 Box of 36

#O-100-1122 Box of 144



DynaFlex® Proxi-Clean Interproximal Brushes

Our newly designed travel brushes feature a larger ergonomic handle that is easier to hold and will not slip during use. Handy for every patient with brackets! Brushes have a plastic cover that becomes an extension when removed. Each package contains 6 different colors: blue, green, orange, red, white, yellow. 144 brushes per package.

#1541

DynaFlex® Orthodontic Toothbrush - 'V' Trim Design

Bristle tips are smooth & evenly rounded using a specially patented process. The rounded tip bristles gently flow across gums, minimizing trauma. The "V" Trim Design allows the brush to perform a thorough cleaning without interfering with orthodontic appliances. Box of 72 (assorted colors). Each Toothbrush is individually bagged.

#O-100-1110



DynaFlex® Travel Toothbrush 'V' Trim Design

The handle doubles as a protective cover. The "V" Trim Design allows the brush to perform a thorough cleaning without interfering with orthodontic appliances. Each Toothbrush is individually bagged. Box of 100 (assorted colors).

#O-100-1112



DynaFlex® Toothbrushes w/ Paste

These toothbrushes have soft plastic bristles with toothpaste powder impregnated into the bristles. Great for patients to use right before their appointment! Assorted packs of 100 individually wrapped toothbrushes.

#0801



DynaFlex® Toothbrushes

A must for every office! Our toothbrushes have high-quality nylon bristles. Toothbrushes are inexpensive enough to be disposable, yet strong enough to be used several times. Assorted packs of 100 individually wrapped toothbrushes.

#0800



DynaFlex® Two Minute Sand Timers

Great for timing kids while brushing their teeth. Box of 50 (assorted colors.)

#O-100-1136





DynaFlex® Therapy Wafers

Helps to relieve orthodontic pain by increasing bloodflow to the gingival tissues. Patient simply chews wafer after wire change appointment to ease pain. Pack of 25. Available in Bubble Gum, Cherry, Grape or Mint scent. Pack of 25.

#1270-BG Bubble Gum

#1270-G Grape

#1270-C Cherry

#1270-M Mint



DynaFlex® Appliance Remover Tool

Our appliance remover tool makes it easy for the patient to remove aligners and other appliances. Allows for easy removal from the cheek-side and the tongue-side of the mouth. Can be cleaned at the same time, the same way as the aligner itself. Pack of 10.

#0870 Blue

#0870-PK Pink

#0870-GN Green

#0870-W White

#0870-O Orange



DynaFlex® Aligner Chewies™

Aligner Chewies™ are the perfect solution for properly seating an imperfect fit aligner. Specifically designed to provide uniform force to one area of the mouth if needed. Aligner Chewies™ are a cleaner alternative to cotton rolls. Available in packs of 20. 10 sealed patient packs of 2.



#0853-W White/Unscented

#0853-M Green/Mint

#0853-G Purple/Grape

#0853-P Yellow/Pineapple

#0853-BG Pink/Bubblegum



DynaFlex® Elastic Attachers

Easily place elastics with these Elastic Attachers manufactured with a hook at one end and a pusher at the other end. Make placement and removal of intraoral elastics easy for your patients. Kids will love the glow in the dark attachers with the sure-grip handle that does not slip. Pack of 250.

#1225-05 Multicolored

Used In The Dynaflex® Lab Everyday!

DynaFlex® Coe Tray Cleaner

Coe Tray Cleaner mixes easily with water to remove alginate, wax and material compounds from metal trays and instruments. Cleans in as little as 15 minutes. Does not contain phosphates. 1-1/2-pound container.

- TO USE:**
1. Stir 2 capfuls of powder into one quart of warm water until completely dissolved.
 2. Remove the bulk material from instruments/trays immerse completely in solution.
 3. Leave items immersed in solution for 15-30 minutes. Stubborn stains may require light brushing.
 4. Rinse. Solution can be mixed HOT for faster residue removal.

#9-250010



DynaFlex® Wood Handled Spatula

Semi-rigid stainless steel spatula with wood handle is a favorite among our customers! Blade length is 3.5" and blade width is 1.25". Overall spatula length is 7-5/8".

#1463



DynaFlex® Disposa-Bowl™

This strong, yet flexible, disposable bowl is ideal for mixing alginate, plaster or stone. Just use it once and throw it away! Made of thin recyclable plastic with side grips for easy handling. Pack of 50 bowls.

#1550-05



Made of thin recyclable plastic

Tired Of Navigating Through Multiple Pages And Hundreds Of Products?

That Ends Now With...

OnCommand

OnCommand was created to make ordering even easier. We've taken your accounts most ordered items and combined them in an easy to navigate grid that can be filtered by product line and/or searched by item name or item number.

Ordering has never been quicker....

LEARN MORE:

www.dynaflex.com/oncommand-tutorials/



miscellaneous

DynaFlex® Disposable Impression Trays

DynaFlex plastic impression trays are color-coded for easy identification of sizes. Now made of plastic that can be cold sterilized, they are more cost effective than ever! Available in six sizes, pedo, x-small, small, medium, large and x-large. Pack of 50.



#1191 Assorted Pack of 60 Trays

ITEM #	SIZE
#1192-U	Pedo Upper (#1 - Red)
#1192-L	Pedo Lower (#1 - Red)
#1193-U	X-Sml Upper (#2 - Orange)
#1193-L	X-Sml Lower (#2 - Orange)
#1194-U	Sml Upper (#3 - Blue)
#1194-L	Sml Lower (#3 - Blue)
#1195-U	Med Upper (#4 - Green)
#1195-L	Med Lower (#4 - Green)
#1196-U	Lg Upper (#5 - Yellow)
#1196-L	Lg Lower (#5 - Yellow)
#1197-U	X-Lg Upper (#6 - Purple)
#1197-L	X-Lg Lower (#6 - Purple)

DynaFlex® Secure Lock™ Disposable Impression Trays

Our new disposable impression trays will quickly become your new office favorite. We named them Secure Lock™ because of the exclusive design that will let the alginate flow easily into the tray and "lock" into place without pulling away, even when you double pour your impressions. High gingival margins. Side view of exclusive locking system. Color coded by size and available in five different sizes. Pack of 50.



ITEM #	SIZE
#1199-1L	X-Large Lower (Yellow)
#1199-1U	X-Large Upper (Yellow)
#1199-2L	Large Lower (Green)
#1199-2U	Large Upper (Green)
#1199-3L	Medium Lower (Blue)
#1199-3U	Medium Upper (Blue)
#1199-4L	Small Lower (Orange)
#1199-4U	Small Upper (Orange)
#1199-5L	X-Small Lower (Red)
#1199-5U	X-Small Upper (Red)

DynaFlex® Stainless Steel Perforated Trays

Made of high quality stainless steel with perforations and edge-lock design. Can be repeatedly sterilized by any method without breakage

ITEM #	ADULT
#1170-01	Upper XL - #1
#1170-02	Upper Lg - #2
#1170-03	Upper Med - #3
#1170-04	Upper Sml - #4
#1170-05	Upper X-Sml - #5
ITEM #	PEDODONTIC
#1190-01	Upper - Lg
#1190-02	Upper - Med
#1190-03	Upper - Sml

ITEM #	ADULT
#1170-11	Lower XL - #1
#1170-12	Lower Lg - #2
#1170-13	Lower Med - #3
#1170-14	Lower Sml - #4
#1170-15	Lower X-Sml - #5
ITEM #	PEDODONTIC
#1190-11	Lower - Lg
#1190-12	Lower - Med
#1190-13	Lower - Sml

TAC™ Tray Adhesive Spray

TAC Tray Adhesive effectively and securely holds alginate in tray when impression tray is removed. 3.5-ounces.

#1187



DynaFlex® Kromopan® Alginate

Simply the best! Keeps its shape up to 100 hours, unsurpassed in quality, detail and compression resistance. Changes color so you know exactly what to do. Purple-Spatulate + Pink-Load Tray + White-Insert Tray. Approx. 50 impressions per pouch.

#1552 1lb. Pouch

#1551 Resealable 1 lb. Canister



DynaFlex® DeBubblizer by DeLar Corporation

Surface tension reducer, eliminates bubble formation and produces sharper details. Simply hold bottle 15cm from impression and spray surface lightly, vibrate stone mix into impression. Available in 8-ounce spray or 32-ounce refill (empty 8-ounce spray included).

#1525 8-ounce Spray

#1525-01 32-ounce Refill



DynaFlex® Alginate Flavor Drops

Alginate flavoring encourages patient cooperation and reduces gagging. Excellent smell and taste for all ages. Simply add 4-6 drops to alginate while mixing. 2 ounce bottle with drip style top.

FUN FLAVORS®
Alginate Flavor Drops



ITEM #	FLAVOR
#1530-A	Awesome Apple
#1530-B	Banana-Rama
#1530-BB	Wild Blueberry
#1530-BG	Yum-Yum Bubble Gum
#1530-C	Red Cherry
#1530-CC	Simply Chocolate
#1530-CI	Cinnamon Stick
#1530-CO	Coolin' Cola
#1530-CT	Circus Cotton Candy
#1530-CD	Mom's Cookie Dough

ITEM #	FLAVOR
#1530-FP	Tutti Frutti Fruit Punch
#1530-G	Jammin' Grape
#1530-M	Cool Mint
#1530-O	Sunshine Orange
#1530-PC	Island Pina Colada
#1530-R	Razzle Dazzle Raspberry
#1530-RB	Root Tootin' Root Beer
#1530-S	Sparkling Strawberry
#1530-V	Vanilla Bean
#1530-W	Wacky Watermelon

Cadco



The DynaFlex® Alginator

The easiest way to mix alginate and stone without the hassle! The new and improved mixer makes a smooth, bubble-free mix while eliminating waste and reducing clean up time. The sleek new design has been updated to compliment your office. Ergonomically designed, with a single speed and improved portability.

#1548 The New Alginator

#1548-01 Alginator Alginate Bowl

#1548-02 Alginator Stone Bowl

#1550-04 Cadco Spatula (Autoclavable)



RACK #1530-05

DynaFlex® Alginate Flavor Caddy

Quickly becoming a best seller! Great for the office that's on the go! Holds 10 flavorings. Caddy dimensions are: 10.5" long x 3.25" deep x 7" tall.

DynaFlex® Alginate Flavoring Rack

Our clear acrylic alginate flavoring organizer is a great way to move from chair to chair! Each rack holds 6 flavorings.

DynaFlex® Pro-form Mouthguards

DynaFlex® Lab Can Also Fabricate These For You.

Professional and amateur athletes alike use Pro-form mouthguards because they provide the highest level of protection, retention, comfort and fit without hindering speech, breathing and most of all athletic performance. The Pro-form custom-fit mouthguard goes above and beyond typical boil-and-bite mouthguards because of its superior fit and retention. In addition, Pro-form mouthguards are thin and comfortable while still maintaining shape and protection long after other mouthguards have worn out.

Pro-form custom-made athletic mouthguards are proven to reduce the incidence of tooth breakage by properly distributing the stress of a hard impact to the entire length of the tooth. A double layer of laminated sheet vinyl and a lingual plate imbedded behind the incisors gives the piece long-lasting durability. The mouthguard maintains its form because of the heat and pressure laminating process. The tensile strength is excellent due to the two layers of laminate while the density is maintained during the pressure laminated process for controlled, uniformed shape.

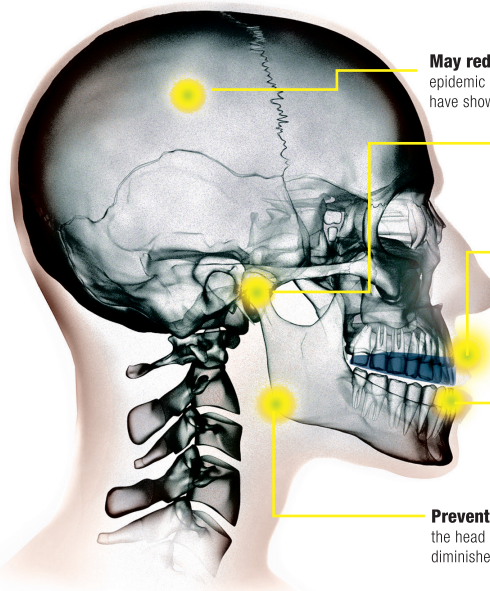

May reduce concussions Concussions are becoming an epidemic in many sports. With a custom mouthguard, studies have shown a possible reduction in concussion cases.

Protects jaw joint A custom mouthguard absorbs and spreads the impact or blow to the face, which may otherwise result in a major injury to the delicate jaw joint.

Protects soft tissue around the mouth Lacerations, bruised lips, cheeks and gums can result from direct impact to the mouth. The reinforcement of a custom mouthguard can eliminate painful soft tissue injuries.

Cushions teeth from high impact Any sport has a possibility of receiving a heavy blow to the teeth and mouth. Wearing a custom mouthguard during athletic competition decreases the chance of chipping, breaking or knocking out a tooth.

Prevents major head and neck injuries Any impact to the head or jaw can create serious injury. A custom mouthguard diminishes the likelihood of jaw dislodgement or neck trauma.

Used at all levels of competition, Pro-form has proven itself as a top performer on the field when athletes need it the most.

DynaFlex® Glitter Guard

Add a little more flash and sparkle with Glitter Guards! By laminating two layers of soft EVA together, the material has excellent tensile strength. 5"x5" Squares, **6 per package.**



ITEM #	GLITTER COLOR
#0751-01	Assorted Glitter
#0751-02	Green Glitter
#0751-03	Orange Glitter
#0751-04	Pink Glitter

DynaFlex® Tie Dye Guards

Pro-Form line features a bold Tie dye design! Pro-form protection you expect in bright patterns! 5"x5" square, **6 per package.**



ITEM #	TIE DYE COLOR
#0752-01	Midnight Tie Dye
#0752-02	Patriot Tie Dye
#0752-03	Wilderness Tie Dye
#0752-04	Flamingo Tie Dye
#0752-05	Shamrock Tie Dye

DynaFlex® Basic Mouthguards

Can't go wrong with the basics! Solid colors sure to please every athlete's team loyalty! 5"x5" square, **12 per package.** Mouthguard Strap shown, sold separately.



ITEM #	BASIC 1 COLOR
#0753-BK	Black
#0753-B	Blue
#0753-C	Clear
#0753-G	Green
#0753-O	Orange
#0753-R	Red
#0753-P	Purple
#0753-Y	Yellow

DynaFlex® Mouthguard Straps

Easy-to-attach helmet straps to be used with Pro-form mouthguards. The strap works great for any sport that has a helmet, such as football, hockey and lacrosse. The strap is especially helpful due to its safety release feature which allows the mouthguard to break away under less than 12 pounds of pressure. **12 Clear Straps per package.**

ITEM #	BASIC 2 COLOR
#0754-01	White/Purple
#0754-02	Black/Red
#0754-03	Black/Yellow
#0754-04	Black/Orange

The DynaFlex® Super-Guard™

- Tapered to increase comfort and protection
- Three breathing vents
- Curved for better fit and comfort
- Tongue guard
- Helmet strap
- Pack of 10

WITHOUT STRAP

ITEM #	COLOR
#1335-B	Blue
#1335-C	Clear
#1335-G	Green
#1335-SI	Silver
#1335-Y	Yellow

WITH STRAP

ITEM #	COLOR
#1336-B	Blue
#1336-C	Clear
#1336-G	Green
#1336-SI	Silver
#1336-Y	Yellow



DynaFlex® Ultraguard Mouth Guards

- Conforms to NCAA guidelines
- Shock absorbing bite tips
- No boiling or impression needed
- Ergonomic contours with free flow air channels
- Pack of 10

WITHOUT STRAP

ITEM #	COLOR
#O-100-1180	Red
#O-100-1182	Green
#O-100-1184	Yellow
#O-100-1186	Blue
#O-100-1188	Black
#O-100-1190	Clear
#O-100-1192	Assorted

WITH STRAP

ITEM #	COLOR
#O-100-1181	Red
#O-100-1183	Green
#O-100-1185	Yellow
#O-100-1187	Blue
#O-100-1189	Black
#O-100-1191	Clear
#O-100-1193	Assorted



opro® SELF-FIT MOUTHGUARDS

Boil & Bite

The perfect fit for all contact sports! Unbeatable protection! The Opro Self-Fit Mouthguards are latex free, made with 2 protective layers and provide the best retention/fit performance of any self-fit mouthguard in the world. Provides maximum protection against front and concussive blows while keeping the palate clear for improved breathing and speech. Mouthguard and case have an antimicrobial additive to prevent germs.

The "Gold Braces Opro®" Is Great For Orthodontic Patients:

- Contains a durable outer layer for superior impact protection
- Revolutionary designed braces bumper for protecting orthodontic patients
- Air spaces for maximum cushioning and protection
- Latex free
- Ages 7 to adult

ITEM #	COLOR
#1328-BK	Black/Pearl
#1328-B	Blue/Pearl



The "Silver Opro®" is great for patients without brackets:

- Durable outer later for enhanced impact protection
- Flexible inner layer for greater comfort and fit
- Ages 10 to adult



Adult

ITEM #	COLOR
#1329-W	White/Black
#1329-B	Blue/Light Blue
#1329-R	Red/Blue

Junior

ITEM #	COLOR
#1329J-W	White/Black
#1329J-B	Blue/Light Blue
#1329J-R	Red/Blue



LABORATORY SUPPLIES



Trims the time. Polishes the model.
Pampers your hands.

Introducing a water-soluble tongue void filler that will save you time while producing a sleek model! Pre-mixed, Wonderfill eliminates time spent mixing alginate filler or grinding out plaster or stone from lower impressions. Simply fill the tongue area with Wonderfill and pour the model. Once the model is set, Wonderfill can be removed without sticking. Wonderfill is water soluble and requires no set-up TIME or special clean-up REQUIRED. 51-ounce tub.

#1549



No mixing, no mess,
no wasted time grinding,
ending in exceptional model
appearance.



Remove a palmful of Wonderfill from tub.

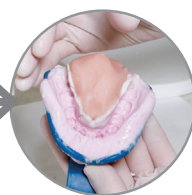

Form a domed bridge in the tongue area.



After plaster/stone fully sets, easily pop out Wonderfill.



With Wonderfill in the tongue area, pour plaster/stone.

DynaFlex® Model Storage Boxes A practical new dimension in orthodontic model storage. Inexpensive, easy to assemble boxes conserve valuable space prior to use. Very sturdy when assembled. Each box has compartments to safely store the models and comes complete with a tray, compartment insert and a sleeve.

4 Compartment Box

Case of 50 boxes: 11" x 3.375" x 1.875"

#0850-4

8 Compartment Box

Case of 50 boxes: 11" x 6.875" x 1.875"

#0850-8



8 Compartment

4 Compartment

DynaFlex® Trap-Eze: Disposable Plaster Trap

The easy, safe and sanitary method for containing and disposing of sink waste. When full, seal trap bucket with snap-on caps provided and discard- No Spills, No Odors! Flexible 18" long vinyl hoses connect to standard 1.75" plumbing outlets in minutes. Available in a 5 gallon or 3.5 gallon Kit. Refills and additional hoses also available.

#O-107-1050 5 gallon 15.25" x 12" Kit

#O-107-1051 5 gallon Refill

#O-107-1052 3.5 gallon 11" x 12" Kit

#O-107-1053 3.5 gallon Refill

#O-107-1054 Hose Set



DynaFlex® Fabulustre Polish

Provides a high-luster finish on all types of metals and acrylic. A special formulation that removes light scratches and produces a fast, mirror-bright final finish without discoloration. Greaseless, dry but not dusty. Easy to clean up and leaves little or no residue.

#0810-312 1/4-lb. Tube

#0810-313 1-lb. Tube



DynaFlex® Ortho-Plaster: Super White

Ortho-Plaster is a pure, fine white plaster used for producing bright white Orthodontic casts. It has high strength, medium expansion and mixes into a smooth, easy-flowing mix that allows ample working time. 50lb. carton.

#O-107-1000

DynaFlex® Ortho-Stone: Super White

Ortho-Stone has exceptional strength and is resistant to abrasion and fracture while still producing a smooth model surface. Minimal setting expansion provides precise, accurate reproduction of detail with Select Dental Ortho-Stone.

#O-107-1003



DynaFlex® Whip Mix

Formulated for consistency, strength, snow white color and ease of handling. Assures good looking, high accuracy models every time. 50lb. carton.

#O-107-1002 Stone

#O-107-1004 Plaster



DynaFlex® Snap-Stone

Exceptionally fast-setting with early high compression strength.

#O-107-1008 11lb. Box

#O-107-1009 33lb. Box



DynaFlex® Plaster Knife

Straight plaster knife with hardwood handle and carbon steel blade 5 1/2" overall length with a 1 3/4" blade.

#1462



DynaFlex® Plaster Nipper

Specially designed for accurate removal of excess plaster from laboratory models. 7 5/8" length.

#1460



DynaFlex® Vibrator General Purpose

- Compact
- Heavy Duty Motor



#O-190-1432

DynaFlex® Touch Activated Gas Burner

Model: GB4105

Self-contained compact burner features electronic instant ignition. Simply rest your hand on the pressure sensitive pad to instantly ignite the burner. Turn the flame adjustment dial to choose the right flame for the job. Lift your hand from the pad to extinguish the flame and shut the unit off.

#O-189-4105



DynaFlex® Water Bath

Our new water bath is economical, thermostatically controlled and suitable for many dental procedures. A selective temperature setting maintains an accurate range of 100° F to 160° F. It's ideal for base plate wax and taking functional construction bites.

#1315 DynaFlex® Water Bath

#1315-001 Plastic Insert 2 1/4", 3 1/4", 4 1/2" (sold individually)





DynaFlex® Orthodontic Study Model Base Formers

Clear, flexible base formers. Two sizes available. Standard size 4-1/2" wide x 1-3/4" deep x 3" long. Pedodontic size 4" wide x 1-3/4" deep x 2-5/8" long. Sold individually.

- #1499-01 Standard Size
- #1499-05 Pedodontic Size



DynaFlex® Muslin Buff

Quality muslin wheel with shellac hardened center. 4" x 30-ply. One per pack.

#0812-01



DynaFlex® Pointed Felt Cones

This solid felt cone is excellent for concave or hard to reach surfaces. 1/2" diameter x 1" length. One per pack.

#0813-01



DynaFlex® Polishing Brushes

Ideal for polishing clear tray appliances. Specifically designed for use with cordless dremel-max speed 13,000 rpm. The brush heads are pre-mounted on a mandrel and made of Scotch-Brite material. Sold individually. Available in three textures. Autoclavable Only.

- A. #0750-F Fine Brush
- B. #0750-M Medium Brush
- C. #0750-C Coarse Brush

DynaFlex® Compo-Covers

Prevents any hardening of light-sensitive set-ups for more than 30 minutes.

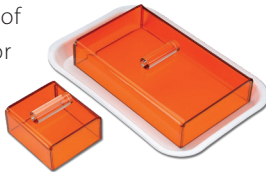

Small 7"L x 4.5"W x 1.5"H inside
#O-190-6150

Extra Small 3/25"L x 2.5"W x 1.5"H inside
#O-190-6152

DynaFlex® Dual Cut Lab Carbide Burs



82-T

#O-109-1210

84-T

#O-109-1216

52-C

#O-109-1220

Individual Bur

DynaFlex® Acrylic & Stone Trimming Bur



Designed especially for trimming stone and acrylics, these burs are made of carbide steel for long life. Wide non-clogging flutes.

#O-109-1202

DynaFlex® Bur For Vacuum Formed Sheets

Makes easy work of trimming vacuum forming plastic sheets

#O-109-1050



DynaFlex® Trimming Wheel

Trim Essix® appliances with this high-quality, rigid one-piece tool.

- Head Size: 10 mm
- Thickness: 0.5 mm
- Maximum Speed: 10,000 rpm

#O-109-1055

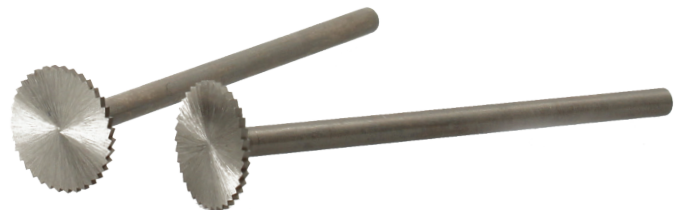

DynaFlex® Lab Burs

High quality, long lasting carbide combined with diamond cutting provides benefits of fast material removal, smooth cutting action, reduced vibration. Designed for maximum control, minimal clogging and minimal heat build up.

STYLE	ITEM	DESCRIPTION
1	#0989-1	Handpiece
2	#0989-2	Handpiece
3	#0989-3	Handpiece
5	#0989-5	Handpiece
6	#0989-6	Handpiece
7	#0989-7	Handpiece
8	#0989-8	Handpiece
10	#0988-10	3/8 " Lathe

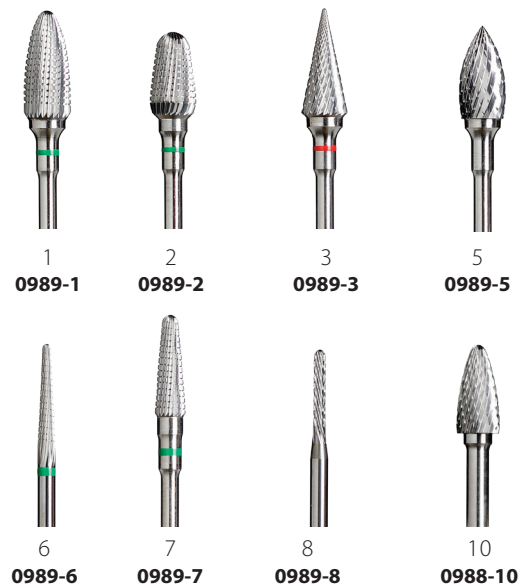

DynaFlex® Bur Blocks

Autoclavable bur blocks are magnetized to keep burs securely in place. Autoclavable up to 250° Fahrenheit. Available in rectangular which holds 14 burs or round which holds 7 burs.

#0991 Rectangular - Holds 14

#0992 Round - Holds 7



DynaFlex® Specialty Burs

Burs designed for specific laboratory materials.

#O-109-1240 H251EF - For Acrylics & Metallic Alloys

#O-109-1242 H251E - For Acrylics, Metallic Alloys & Plaster

#O-109-1244 H79GSQ - For Soft Acrylics



DynaFlex® 16 Fluted Burs

Primarily used for finishing composites, although also used for smooth preparations.

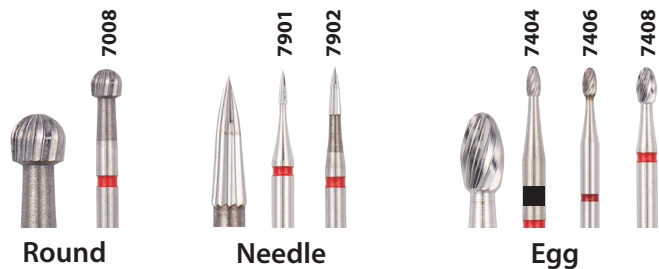

DESCRIPTION	7008	7901	7902	7404	7406	7408
Handpiece Shank	N/A	#O-109-1252	N/A	#O-109-1256	#O-109-1258	#O-109-1260
Friction Grip	#O-109-1280	#O-109-1282	#O-109-1284	#O-109-1286	#O-109-1288	#O-109-1290

DynaFlex® Q.C.M. Labial Bow

Does your patient need a retainer but you want that beautiful smile to show through? Q.C.M. Labial Bows are the answer! Aesthetically pleasing, Q.C.M. Labial Bows are easy to form, no special tools required. Available in 42mm, 48mm, and 54mm. Sold individually.

- #2013-42 42mm
- #2013-48 48mm
- #2013-54 54mm



DynaFlex® Adams Clasp

Spring tempered precision formed clasp. .028 wire diameter. Available in eight sizes. Pack of 100.

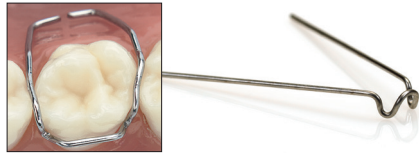

SIZE	100 PACK
5mm	#1130-5
6mm	#1130-6
7mm	#1130-7
8mm	#1130-8
9mm	#1130-9
10mm	#1130-10
11mm	#1130-11
12mm	#1130-12

DynaFlex® Ball Clasp

Our spring tempered ball clasp is better than ever. We guarantee this to be the shiniest ball clasp available. These are the exact same ball clasps we use in our laboratory everyday. Pack of 100.

SIZE	ITEM #
.024	#1124-1
.028	#1128
.032	#1132
.036	#1136-1
.040	#1140

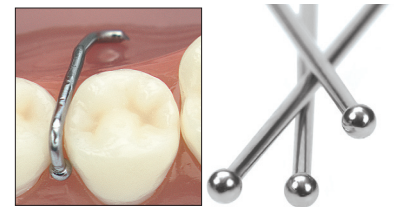

DynaFlex® 14" Straight Lengths - Stainless Steel

Economical wire excellent for laboratory use or spring formation. Available in round and rectangular. 10 lengths per tube.

Round			
SIZE	ITEM #	SIZE	ITEM #
.012	#0950-012	.032	#0950-032
.014	#0950-014	.036	#0950-036
.016	#0950-016	.040	#0950-040
.018	#0950-018	.045	#0950-045
.020	#0950-020	.048	#0950-048
.028	#0950-028	.056	#0950-056
.030	#0950-030		

Rectangular	
SIZE	ITEM #
.016 x .016	#0951-016
.016 x .022	#0951-022
.017 x .025	#0951-017
.018 x .025	#0951-018
.019 x .025	#0951-019
.021 x .025	#0951-021

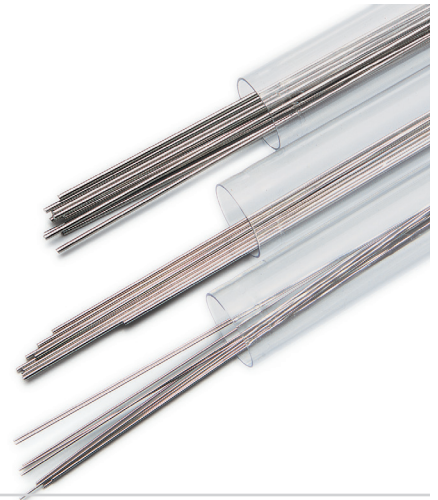

DynaFlex® Retainer Wire Stainless Steel

14" Lengths. Pack of 50

SIZES	ITEM NUMBER
.024	#O-951-7024
.028	#O-951-7028
.030	#O-951-7030
.032	#O-951-7032
.036	#O-951-7036
.040	#O-951-7040
.045	#O-951-7045

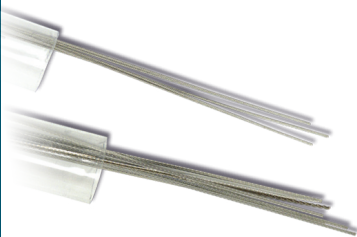

DynaFlex® Heavy Wire Cutter

This cutter is capable of cutting all sizes of orthodontic wire. Excellent for lab use. Cutter features spring action handle for easy use. 5 1/2" long.

#1461



The DynaFlex® Micro Torch

Model: GB2001

The Original Micro Torch! The GB2001 features state-of-the-art Piezo Electronic Ignition, a powerful 2500°F blue torch flame, and an air flow adjustment dial for superior flame control. Includes a detachable base for hands-free work. The first and still the best! Fuel Capacity: 26 grams

#0791-05

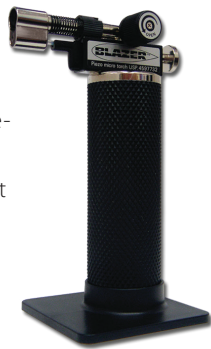

DynaFlex® ES-1000 Self-Igniting Micro Torch

Self starting, hand held, piezo electric. Refillable with butane gas. Easy to adjust precise flame.

#0791



DynaFlex® PT-4000 Cordless Pencil Torch

New high tech cordless pencil torch is a versatile, butane powered tool with virtually unlimited number of uses. 30 minutes of continuous use. Convenient compact size with automatic one second ignition.

#0790



DynaFlex® Butane Refills

Triple refined butane that burns cleaner and will not clog air flow of your torch. Twice as effective as store bought butane!

#0792

Universal tip for refill of all brands of torches is included



DAPDISH™ Dental Dappen Dishes

Disposable, yet sturdy dappen dishes available in assorted colors. 200 assorted colors per box.

#1599



DynaFlex® Smart-Key

The Smart-Key has been developed to ensure full activation detection while turning RPE screws. Simply move the key tip toward the front stop, insert the key into REP expander screw and push the key handle toward the throat. The key head and tip will rotate as the RPE is activated. Push the key until a full π turn activation stop is reached, a slight "bump" or "click" may be felt as the full activation stop is reached. 10 per package.

#3017



DynaFlex® Safety Key

This long handled key allows for easy turning of screws and prevents the patient from swallowing the key. The button is made of super-safe Hi Impact Polystyrene that cannot be removed. Both styles can be used with and work well with all screw mechanisms. 10 per pack.

#3010-K New & Improved

#3011 The Original



DynaFlex® Expansion Screws

Midline Upper & Lower: Expansion 7mm, Length 11mm, Width 7mm
#3100-2000

Midline Lower: Expansion 5mm, Length 10mm, Width 6mm
#3130-2000

Midline Upper: Expansion 7mm, Length 11mm, Width 10mm
#3150-2000

Midline Upper: Expansion 11mm, Length 15mm, Width 10mm
#3150-2011

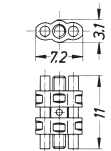

#3100-2000

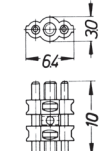

#3130-2000

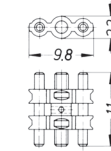

#3150-2000

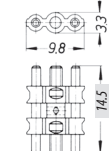

#3150-2011

DynaFlex® Memory Expander

Niti inserted expansion screw makes for faster movement and more comfortable expansion of the palate.

#3167M1529

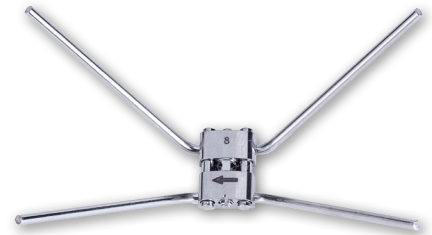

DynaFlex® Super Screw Telescopic Maxillary Expander

- Innovative telescopic design
- Eliminates back-turning
- Activation from front of mouth
- Expansion limit indicator
- Graduated scale



#O-160-1027 16 mm

#O-160-1035 12 mm

DynaFlex® Locking Nut

#O-160-1036

DynaFlex® Super Screw Wrench

#O-160-1037

DynaFlex® Snap Lock Expanders

The Snap Lock Expander does not turn back unless the doctor or patient turns it back. After activation of the spindle, the flat spring snaps in. When the Snap Lock Expander is properly activated by ¼ turn, both the patient and doctor will be able to feel the screw "lock". The hole in the spindle is always in the correct position for reactivation/turning. By chance if the Snap Lock Expander is overactivated, it can be turned back.

8mm Snap Lock Expander

#3-A167-1239

10mm Snap Lock Expander

#3-A167-1439

12mm Snap Lock Expander

#3-A167-1639

DynaFlex® RES Screw – Ratchet Expansion Screw

This expansion screw produces an audible "click" with each ¼ mm turn of the screw, making it easy for parents and patients to know they've made the correct advancement and preventing back-up! An additional built-in safety feature prevents separation of the screw intraorally. Screw advances up to 11mm in 1/4mm increments. Includes Safety Key.

#3120 2-Arm

#3125 4-Arm



High Quality Expansion Screws

DynaFlex® Palatal Expanders

Our best selling palatal expanders are available with pre-bent, straight or no arms.

EXPANSION	ARMS	ITEM #
12mm	Straight	#3602-811
12mm	Pre-Bent	#3602-812
10mm	Pre-Bent	#3602-808

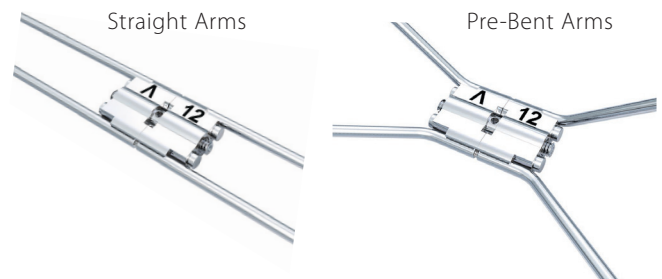

DynaFlex® Variety RPE

Originally developed for use in the mandible, these RPE's can be used for early palatal expansion in the maxilla. The compact design allows for patient comfort, the laser-welded arms are capable of handling a high mechanical load and with only two arms, the appliance applications are numerous.

#3602-806 12mm

#3602-815 8mm



DynaFlex® palex® RPE "Click" Expanders

The palex® RPE "Click" Expander has a patented "Click" feature to prevent unwanted reversing for rapid palatal expansion in the fixed appliance. When the palex® RPE "Click" Expander is properly activated by ¼ turn, both the patient and doctor will be able to feel the screw "lock". The hole in the spindle is always in the correct position for reactivation/turning. By chance if the palex® RPE "Click" Expander is overactivated, it can be turned back.

#3602-830 8mm palex®

#3602-832 10mm palex®

#3602-834 12mm palex®

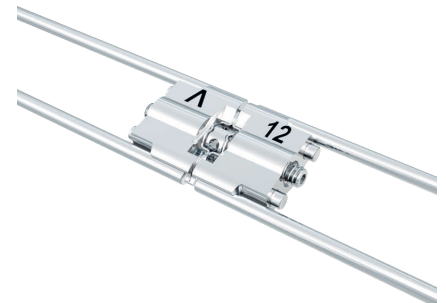

DynaFlex® Variety SP Expansion Screw

Variety SP Expansion Screw offers versatility for both upper and lower fixed technique applications. This Stealth™ screw offers a high degree of intraoral comfort. Arms are laser-welded, the two arm design allows for numerous application options. Available in 8mm or 12mm.

#3602-819 8mm

#3602-809 12mm



Euro-Cryl™ Orthodontic Acrylic

Maximum strength, high density, less breakage. Allows for adequate working time. Will not slump. Polishes to a beautiful luster. Available in kits or in bulk packaging.



Polymer and Monomer Kits

ITEM	DESCRIPTION
#1561-PL	Clinic Combo - 1 lb. Polymer & 8 oz. Monomer
#1562-PL	Lab Combo - 5 lbs. Polymer & 1 quart Monomer

Polymer Only

ITEM	DESCRIPTION
#1561-P	1 pound
#1562-P	5 pounds

Monomer Only

ITEM	DESCRIPTION
#1561-L	8 ounces
#1562-L	1 quart



laboratory supplies

Lang Aquapres®

Cures Acrylic without Heat! The Lang Aquapres is a hydraulic pressure curing unit designed for use with self-curing resins. Eliminates porosity in methacrylate acrylics and provides long-lasting color stable results. Works without heat, electricity or compressed air. Maintenance free and easy-to-use. Simply fill unit with tap water, place models in unit, replace top and turn handle to desired pressure. Optimum effective pressure is 30 lbs. Holds pressure for hours at a time. 2-year unconditional guarantee. Stainless steel frame and plastic bowl. Overall dimensions: 9"Hx6.5"Wx5.25"L. Inside diameter is 5" and inside height is 3.5". Red.

#0722



DynaFlex® Aluminum Oxide For Microetcher

Aluminum Oxide can be used with any sandblasting machine. Available in 50 micron or 90 micron. 50 micron is white in color and 240 grit. 90 micron is gray in color and 150 grit. Both packaged in 1 lb. bottle.

#0740 50 Micron

#0740-2 90 Micron



DynaFlex® Microlab Digital Micromotor

High quality heavy duty micromotor with state-of-the-art Microprocessor Control. 35,000 RPM, hand or foot control, forward or reverse, has a twist-type chuck release. Easy to change chucks. Improved dust seal protection. Heavy duty front bearings with safety overload.

#O-190-8000C



DynaFlex® Micro-Etcher II Intra-Oral Micro Sandblaster

Fully Autoclavable Tip Recommended by top dental authorities across the country!!!
Excellent for chairside use. Enhanced bond strength for all procedures. Quick disconnect kits available.

- #0735 Micro-Etcher II
- #0735-5 Micro-Etcher IIA
- #0736 Quick Disconnect Kit
- #0737 4-Hole Handpiece Adapter
- #0735-4 Micro-Etcher Tip-60°
- #0741 Micro-Cab Plus (6-1/2" x 6-1/2" x 12")
- #0741-2 Macro-Cab Plus (9.8" x 12" x 7")
- #0742 Micro-Cab Plus Replacement Glass
- #0742-2 Macro-Cab Plus Replacement Glass
- #0743 Micro-Cab Plus Handguard Kit
- #0743-2 Macro-Cab Plus Handguard Kit



Disposable

- #0744 Micro-Cab Plus Replacement Shields (10)
- #0744-2 Macro-Cab Plus Replacement Shields (10)

DynaFlex® Low Speed Classic Motor

- Extremely High Torque and Exceptionally Low Noise Levels
- Adjustable Forward and Reverse Speeds up to 20,000 rpm
- Light Weight and Well Balanced
- 4 Hole



#O-190-8016

DynaFlex® Torque Master

- Light Weight and Well Balanced
- Excellent for Prophylaxis
- Fits All Contra Angles & Straight Burs
- Adjustable from 0 – 20,000 rpm
- 4 Hole Model



#O-190-8014

DynaFlex® High Speed Air Handpiece

- Streamlined, Lightweight Design
- Super Reliability and Low Noise
- Perfectly Balanced & Extremely Comfortable to Hold
- 4 Hole Model

#O-190-8020



Push-button grip-lock cartridge features extreme gripping & locking power, yet easy to change burs.

DynaFlex® Doriot Latch Head



#O-190-8029

DynaFlex® E-Type Front End Nose Cones & Contra Angles

Nose cone accepts diamond disc guard and turns 40,000 RPM to 10,000 RPM. Perfect balance. Simple and Safe Locking Mechanism. Full 360° swivel. Fits all "E" type handpieces.

#O-190-8025 1:1 Straight Nose Cone

#O-190-8026 4:1 Reduction Straight Nose Cone



★★★
**BEST
SELLER**

GLACIER®

Ultra Premium Thermoform Material

Glacier® is an Ultra Premium Thermoform Material that we built for durability, clarity and comfort during treatment. It provides excellent ductility that adapts to undercuts and gingival embrasures, while being flexible enough to allow comfortable insertion and removal. Glacier® offers a high range of activation and memory while applying biocompatible forces with superior aesthetic quality for precise tooth movements. Glacier® is a DynaFlex® proprietary material, manufactured to our specifications and high quality standards.

For Fabrication of Aligners and Retainers

- Durable
- Superior Clarity
- Grab-Force Technology
- Enhanced Tooth Movement
- Box of 100
- Made In The USA



SIZE	SHAPE	ITEM NUMBER
.030 x 125mm	Round	#0764-030
.035 x 125mm	Round	#0764-035
.040 x 125mm	Round	#0764-040
.030mm	Square (5"x 5")	#0765-030
.035mm	Square (5"x 5")	#0765-035
.040mm	Square (5"x 5")	#0765-040



**Bulk Purchases Of Glacier® Material Are Available.
Call Our Customer Care Team For Details!**

Scan The QR Code
To Learn More

DynaFlex® Thermaknife

The improved way to quickly and easily trim bleaching trays, mouthguards, and many other thermoplastic materials.

- Fully adjustable temperature control for precise cutting action
- Cutting tip heats ultra-fast to save time and eliminate waiting
- Lightweight pen features an ergonomic design and sharp, permanent tip for improved comfort and control
- Fast and easy pen replacement
- Convenient pen rest provides added safety when unit is not in use



#O-205-1060 Intro Kit (includes Knife Edge Pen)

#O-205-1061 Replacement Pen with Concave Tip

#O-205-1062 Replacement Pen with Knife Edge Tip

#O-205-1063 Replacement Pen with Waxing Tip

DynaFlex® Electric Heat Knife

Capable of cutting any thermoforming plastic up to a 4mm splint material.



#O-205-1004

DynaFlex® Vacuum Former

Make Retainers In House! You are sure to be pleased with the quality of this unit. Easy to use. Silicone gasket ensures a long life. Five year warranty, the longest warranty available. Made in the U.S.A. Complete sample pack of material accompanies unit.



#0765 Standard

#0765-01 220 Volt
(Not for use in U.S.A.)

DynaFlex® LC Blockout Resin

Block-Out Resin provides reservoir space for bleaching trays. It's also useful for other laboratory procedures such as model and die repairs. LC Blockout can be rapidly and efficiently delivered with the Black Mini® tip. It must be light cured and is not intended for intraoral use.

- Low viscosity for easy flow
- Blue pigment for easy visibility
- Great utility resin with numerous cases

#O-115-1140 Two 2g Syringes



DynaFlex® Heat Sealer

8" sealer creates water tight seals. Great for shipping of finished dentures. Perfect for sealing autoclave tubing!



#O-120-2046 Heat Sealer

#O-120-2047 Repair Kit

DynaFlex® Dry Heat Sterilizer Tubing with Indicator

#O-120-2048 2" wide x 100 feet

#O-120-2050 4" wide x 100 feet

#O-120-2054 6" wide x 100 feet

DynaFlex® Dry Heat Bags: Self-Sealing

Features color changing strip with dry heat sterilizer temperatures. Dimensions: 2.5" x 1.5" x 10.5". Box of 250 bags.



#O-120-2060

DynaFlex® Sterilization Pouches



Triple seal combined with medical grade paper and plastic provide maximum protection. Indicator arrows verify sterilization. Available in 2 sizes. Box of 200 pouches

#O-120-2056 3.5" x 9"

#O-120-2058 5.75" x 10"

DynaFlex® Tray covers

Box of 1000

#O-120-2000 Ritter - 8.5" x 12.25" White

#O-120-2028 Weber - 11" x 17.5" White



DynaFlex® Set Up Trays

- Flat B Size: 13.5" x 9.625" x .875"
- Divided B Size: 13.5" x 9.625" x .875"
- Tub Size: 9.5" x 11.5" x 2.625" x .25"
- Mini F Size: 9.625" x 6.625" x .875"

DynaFlex® Set Up Racks

#O-121-2301 Mini Tray Rack (Holds 6 Trays)

#O-121-2302 Rack for B Trays (Holds 8 Trays)

#O-121-2303 Rack for Tub Trays (Holds 4 Trays)

COLOR	FLAT B	DIVIDED B	TUB	MINI F
Grey	#O-120-2214	#O-120-2246	#O-120-2278	#O-120-2310
Black	#O-120-2220	#O-120-2252	#O-120-2284	#O-120-2316
Blue	#O-120-2222	#O-120-2254	#O-120-2286	#O-120-2318
Yellow	#O-120-2228	#O-120-2260	#O-120-2292	#O-120-2324
White	#O-120-2234	#O-120-2266	#O-120-2298	#O-120-2330
Neon Blue	#O-120-2236	#O-120-2268	#O-120-2300	#O-120-2332
Neon Green	#O-120-2240	#O-120-2272	#O-120-2304	#O-120-2336

Tub Size



Divided B Size



Flat B Size



Mini F Size



Try Our Glacier Material (pg. 190)

Super Clear, Made In The USA. A Great Replacement For ACE Material!

Essix® Plastic Sheet: "ACE":

Best for Aligners and Retainers. Clear, rigid and accepts bonding agents. Ideal for retention, minor tooth movement and temporary bridges using Essix pontics.

#O-205-1022

5" Square .030mm (100) 1A350

#O-205-1023

5" Square .035mm (100) 1AH50

#O-205-1024

5" Square .040mm(100) 1A450



Essix® Plastic Sheet: Type "A+":

Excellent when the patient wears the appliance full time. Crystal clear. Rugged, inexpensive, excellent flex memory, and a snap-in fit is insured. Light reflection properties makes the teeth look brilliant. .040" Type "A" used exclusively for moving teeth with Windows and Divots™. Acrylic will bond to Essix® Type 'A'. (Patent Pending)

Type "A+" For Essix® Retainers:

- #0769-01 BIOSTAR® 125mm SQUARE .020"(.5mm) 100 sheets 10020
- #0769-02 VACUUM 5" SQUARE .020"(.5mm) 100 sheets 10025
- #0769-03 VACUUM 5" SQUARE .030"(.75mm) 100 sheets 10035
- #0769-04 BIOSTAR® 125mm SQUARE .030"(.75mm) 100 sheets 10030
- #0769-05 BIOSTAR® /MINISTAR® 125mm CIRCLE .030" (.75mm) 100 sheets 11030
- #0769-06 ERKOPRESS 120mm CIRCLE .030" (.75mm) 100 sheets 10031
- #0769-07 VACUUM 5" SQUARE .060"(1.5mm) 50 sheets 10065
- #0769-09 BIOSTAR® 125mm SQUARE .080"(2mm) 50 sheets 10080
- #0769-10 VACUUM 5" SQUARE .080"(2mm) 50 sheets 10085
- #0769-11 BIOSTAR® /MINISTAR® 125mm CIRCLE .080" (2mm) 50 sheets 11080
- #0769-12 ERKOPRESS 120mm CIRCLE .080" (2mm) 25 sheets 10081
- #0769-13 BIOSTAR® /MINISTAR® 125mm CIRCLE .120" (3mm) 25 sheets 13125
- #0769-14 VACUUM 5" SQUARE .120"(3mm) 25 sheets 13500

Type "A+" For Tooth Movement with Divots & Windows™:

- #0769-15 VACUUM 5" SQUARE .040" (1mm) 100 sheets 10045
- #0769-16 BIOSTAR® 125mm SQUARE .040" (1mm) 100 sheets 10040
- #0769-17 BIOSTAR®/MINISTAR® 125mm CIRCLE .040" (1mm) 100 sheets 11040
- #0769-18 ERKOPRESS 120mm CIRCLE .040" (3mm) 100 sheets 11041

Essix® Plastic Sheet: Type "C+":

For night wear and/or when the patient bruxes or grinds. No plastic on the market combines the features of clarity, esthetics, resistance to wear and formability that is inherent in Essix® Type 'C' plastic. This plastic will not crack or bubble, has outstanding wear resistance. We guarantee to replace any appliance that cracks within 12 months with two pieces of Essix® Type 'C' plastic at no charge! Acrylic will not bond to Essix® Type 'C'. (Patent Pending)

- #0768-125 BIOSTAR®/MINISTAR® 125mm CIRCLE .040" (1mm) 100 sheets 1C125
- #0768-478 BIOSTAR® 125mm SQUARE .040" (1mm) 100 sheets 1C478
- #0768-500 VACUUM 5" SQUARE .040"(1mm) 100 sheets 1C500

Hygienic Waxes

Yellow Bite Wafers

Yellow Bite Wafers are a single layer of soft bite wax, U-shaped and designed to adapt to the dental arch. Provides quick, precise bite-checks. 50 wafers per box.

#1306-0839



Extra Hard Green Bite Wafers

These extra hard green bite wafers are non-brittle and won't shatter when chilled. Softens quickly in warm water and can be shaped for full arch coverage. 36 wafers per box.

#1306-3365



Laminated Blue Bite Wafers

Aluminum foil is laminated between two layers of soft bite wax. Aluminum foil lessens distortion and prevents patient from biting through the wafer. 24 wafers per box.

#1306-0825



U-Shaped Occlusal Rims

U-shaped, pink wax blocks. The recessed base aids in adaption to the base plate.

#250-1050 Box of 21

#250-1052 Box of 100



Orthodontic Tray Wax Strips

Used for peripheral lining of impression trays. Increases the tray height. Soft and tacky, and can be adapted without heating. 48 strips per box, each strip 6" x 1/4".

#1306-0827

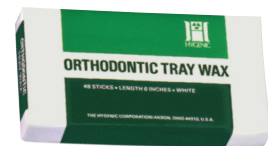

Utility Wax Strips

Shaped in round strips, used for preserving the periphery roll & extending and building up impression trays and post-damming. Sized 11" long x 3/16". Box of 80.

#O-250-1048



Yellow Bite Wax

Made from a blend of fresh, clean wax and can be used under hot water. Supplied in sheets.

#O-250-1045 1lb. Box

#O-250-1046 5lb. Box



Baseplate Wax

Extra Tough Pink

#O-250-1036 1 lb. Box

#O-250-1035 5 lb. Box

Medium Soft No. 3 Pink

#O-250-1041 1 lb. Box

#O-250-1040 5 lb. Box

Red

#O-250-1031 1 lb. Box

#O-250-1030 5 lb. Box



Yellow Check Bite Wafers

Gives quick, precise check-bites and occlusal transfers.

Regular

#O-250-1000 Box of 56

#O-250-1002 Box of 192

Extra Thick

#O-250-1003 Box of 24

#O-250-1004 Box of 168



Yellow Check Bite Wafers

A single layer of soft bite wax, U-shaped & designed to adapt to the dental arch. Gives quick, precise check-bites and occlusal transfers.

#O-250-1006 Box of 192



DynaFlex® Sticky Wax

A hard fast-setting wax. Repairs wax patterns and welds waxes together.

Melts at 73°C /163°F.

#O-250-1060 Case of 18 sticks

#O-250-1062 Box of 120 sticks



DynaFlex® Silver Solder

Lab technician's love our easy-to-work-with solder because of the smooth flow. Usable with gold, silver or stainless steel. Cadmium free with a melting point of 756 degrees F. The larger gauge enables you to use less and save more. 5-DWT. 4 foot spool.

#0718 .045

#0718-5 .025

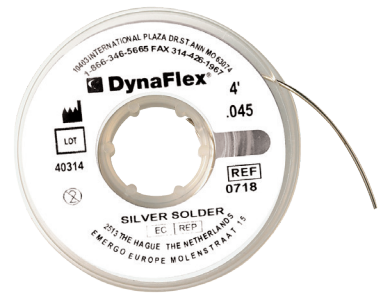

DynaFlex® Flux

Smooth quick flowing flux makes your soldering easy and consistent in color. 7 ounce jar.

#0719-05



DynaFlex® Notched Electrodes

Silver solder notched electrodes used for soldering elastic hooks, head-gear hooks and stops and tiebacks. 100 per package.

#0720-N

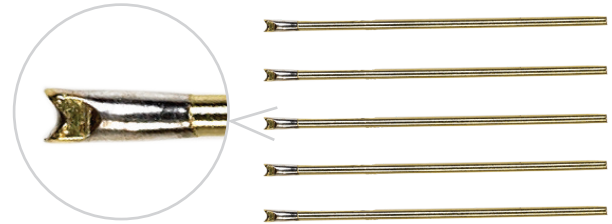

DynaFlex® Ball Electrodes

Silver solder ball electrodes are excellent for reinforcing wires to models, attaching auxiliaries, reinforcing the lingual surface of anterior bands, and work with lingual arches. .032 brass wire. 100 per package.

#0720-A Small

#0720-B Medium

#0720-C Large



DynaFlex® Patient Relief Wax In Bulk Boxes

Makes 540 Wax Packs! Same great high grade wax used in our regular wax packs! Contains 450 strips measuring 12" in length by 3/16" width.

#O-100-1068



L'il Palates™

A simple, yet very useful device used to remove food that gets trapped between the expander and the palate. The soft, flexible plastic hook retracts from the housing similar to a pocketknife design. Sold in pack of 12.

#8010 Blue

#8020 Purple



Cavicide1™

1 minute, 1 Step Surface Disinfectant Liquid. The all new, exceptionally fast and effective CaviCide1 is the next generation surface disinfectant. CaviCide1, a multi-purpose disinfectant/decontaminant cleaner can be used on hard, non-porous surfaces. The improvements found in the latest formulation are effective inkilling 99.9% bacteria, viruses and fungi in 1-minute including TB, Norovirus, A. baumannii, HIV-1, HBV.HCV and many more. When used as directed, the fragrance free CaviCide1 will effectively clean and disinfect surface and can help reduce the risk of cross contamination.

#4060-5000 1 Gallon

#4060-5024 24 Fluid Ounce Spray Bottle



CaviCide1™ Wipes

Disposable towelettes are pre-saturated with CaviCide Surface Disinfectant Cleaner. These wipes are convenient, durable, non-woven, nonabrasive towels that will not bunch up during use. Recommended for nonporous surfaces. The only towelette proven to kill TB in 5 minute and HBV in 3 minutes! 160 Towelettes per canister.

#4060-5100 Regular Size 6" x 6.75" 160/Canister

#4060-5150 XL Size 9" x 12.65" 65/Canister



MEDICA 28™ Plus Cold Sterilant

Eliminate the risk of cross contamination! Health care professionals understand the risk posed by the life-threatening infectious diseases found in today's medical environments-they need to feel secure that their instruments and equipment are free of infectious diseases. Medica 28™ Plus is classified for disinfection and sterilization in the critical and semi-critical categories, Delivering one-step protection in the following areas: Tuberculocidal, Sporicidal, Virucidal, Pseudomonacidal, Bactericidal and Fungicidal. Designed for use on sharp instruments, instruments with a lens, thermometers, anesthesia equipment, metal objects, respiratory therapy equipment, rubber and plastic objects and flexible fiber-optic endoscopes. Mild pleasant odor, contains no phenol, the new solid activator assures a consistent efficacy level throughout 28 days of continuous use. 1 gallon.

#4006-02



DynaFlex® SteriDent Dry Heat Sterilizer

This economical dry heat sterilizer is perfect for your practice. Available in two models: #200 equipped with two trays, #300 equipped with three trays. One year full warranty. Five year warranty on heating element.

Model #200 - w/ 2 trays - 15-1/2" x 10-1/2" x 9-1/2"
#0798

Model #300 - w/ 3 trays - 19-1/2" x 14-1/2" x 11"
#0799

Dry Heat Bags - 250
#0798-01



DynaFlex® Hot Air Sterilizer - RH-PRO11

The RH-PRO11 is a High-Velocity Hot Air (HVHA) Sterilizer ideal for any office setting. Waterless sterilization with no chemicals, uses 85% less energy than steam sterilizers. Can accommodate Small and Large Cassettes and 4 Large Instrument Trays per cycle. Documents cycles for easy log retrieval. The Self-Locking door ensures cycle completion. Manufacturer's Suggested Retail \$8100. 3 year parts and labor warranty.

Cycle 1: 6 min. for unwrapped instruments.

Cycle 2: 8 min. for handpieces and medical drills.

Cycle 3: 12 min. for pouched, wrapped instruments, trays and cassettes

#0789-PRO11

* KN95 FM Sterilizer

Overall Dimensions

Width: 22.5"

Depth: 22.5"

Height: 19.5"

Chamber Dimensions

Width: 11"

Depth: 17.75"

Height: 11.75"

Weight: 75 lbs.

Instrument Tray

Width: 9"

Depth: 15"

Height: 1"

Electrical

110-120V, 60Hz, 1400 Watts warm up, 300 Watts operating

220-240V, 50Hz, 1400 Watts warm up, 300 Watts operating

Sterilization Temperature: 375° Fahrenheit (190° Celsius)



*Includes: Instruction/Care Card, User Manual,
 4 Instrument Trays, 1 pair of Removal Safety Gloves
 and a KN95 FM Sterilizer.*

Need Help Placing Your Order?

Our highly trained and skilled Customer Care Team is here to assist you with any questions you may have.

Call **866-346-5665** or Chat Live
 Online at **www.dynaflex.com/order**



Premium Stylish Safety Glasses

DynaFlex® Tortoise Shell

Designer look! Smooth styling lends a feminine flare to these glasses. Tortoise shell frames with clear lenses. Molded nose piece adds to designer style.

#0827



DynaFlex® Light Curing Glasses

Filters out 98% of dangerous blue light and 100% protection from UV light. Impact resistant. Non-distorting and optically correct.

#0824-011



DynaFlex® Light Cure Glasses

Protects against halogen curing light exposure. Adjustable temples allow for varied protective angles, provides wraparound protection.

A. #0831 Skyper Orange

B. #0832 Orange Blockers



UVEX® Spartan 400

Sporty wrap-around design of these safety glasses provides style, protection and fit with economy in mind! Completely clear frame and lens. One-piece construction. Anti-fog and Hardcoat coating on lenses.

#0828-400





DynaFlex® Disposable Air & Water Pre-Punched Syringe Sleeves with Ties

Also Fits Hand Pieces, Saliva Ejectors, Cavitrons & HVE Valves. Pre-punched for easy slide through. Covers the 3 way syringe. Helps reduce cross contamination. Dispenser Box with 500 Sleeves & Ties.

#O-121-1020 Clear



DynaFlex® Lock Top Tray Sleeves: Disposable

The Lock Top design covers the entire tray, greatly reducing the possibility of cross contamination. Minimize staff time spent cleaning trays. Replaces paper tray covers. Available in two sizes. Dispenser box with 500 clear sleeves.

#O-121-1014 10.5" x 14"

#O-121-1016 11.625" x 16"



DynaFlex® Chair & Stool Covers: Disposable

Tapered Top for Customized Fit

Covers top half of operatory chair including the headrest and controls from damaging effects of surface disinfectants such as cracking and fading. Dispenser box with 200 clear covers.

#O-121-1008



DynaFlex® Headrest Covers: Disposable

Protects headrest on operatory chair from damaging effects of surface disinfectants such as cracking or fading. Minimizes change over time. Available in two sizes. Dispenser box with 250 clear covers.

#O-121-1010 10" x 11.25" (Regular)

#O-121-1012 10" x 14.5" (Large)



DynaFlex® 2" X 2" Sponges

- Non-Sterile
 - Cotton Filled
 - Case of 5000
- #O-120-3100

DynaFlex® C-fold towels

- 16 packs per case
 - 150 sheets per pack
- #O-120-3110 #151



DynaFlex® 5 oz. Plastic Cups

Case of 1000

- #O-120-3112 Blue
- #O-120-3114 White



DynaFlex® #2 Cotton Rolls

Case of 2000

#O-120-3120



DynaFlex® Patient Bibs

Case of 500

- #O-120-3180 Blue
- #O-120-3182 White



DynaFlex® Dri-Angles

Contoured To Fit Inside The Cheek

- Placement of bands
- Placement of brackets
- Insures dry field for acid etch
- Effectively covers parotid duct

Silver

- #O-120-3164 Small: Pack of 400
- #O-120-3166 Large: Pack of 320

Plain

- #O-120-3168 Small: Pack of 400
- #O-120-3170 Large: Pack of 320

DynaFlex® Parotisroll Special Dental Roll

- Labially: holds the lip away, ideal for bonding
- Lingually: holds the tongue down
- Buccally: presses on the salivary gland reducing flow, retracts the cheek and helps keep the mouth open
- Package of 100



- #O-120-3134 #1- 3"L x .375" Dia.
- #O-120-3136 #2- 3"L x .4375" Dia.
- #O-120-3138 #3- 4"L x .4375" Dia.
- #O-120-3140 #5- 4"L x .3125" Dia.

DynaFlex® Oral Evacuators

Vented or Non-Vented. Bag of 100

#O-120-3156



DynaFlex® Saliva Ejectors

Case of 1000

#120-3158



A

Acrylic	188
Adams Clasps	184
Adhesives	114-116, 119, 122-124
Alginate	175
Alginate Flavoring	175
Alginate Flavored	175
Aligner Chewies	172
Aluminum Oxide	188
Appliance Remover Tool	172
Archwire Markers	86
Archwire Stops	92-93
Atlas Brackets	26-35

B

Ball Clasps	184
Bands	54-56, 58-59
Band Pusher	66
Barrier Products	200-201
Bicuspid Bands	58-59
Bite Opener	99
Bite Sticks	66
Boley Gauge	155
Bondable Lingual Retainers	99
Bondable Molar Brackets	62-65
Bonding Brushes	128
Bonding Pads, Disposable	127
Bonding Trays	127
Bonding Tray Organizer	127
Brace Gard/Magic Touch Antiseptic Gel	167
Bracket Placement Instruments	69
Bracket Wax	166-167
Braided Archwire	87
Brushing Timers	171
Burs	121, 182-183
Butane Refills	185

C

Cavicide1	197
Cavicide1 Caviwipes	197
Cervical Cushions	110
Cheek Retractors	130, 132-134
Chill Spray	76
ClearTec Brackets	46-47
ClearViz+ Brackets	44-45
ClearViz+ Mini Brackets	42-43
Coated Archwire	84
Coated Springs, Ligs & Koby Ties	95
Coax Archwire	87
Coe Tray Cleaner	173
Coil Spring	94-95
Comfort Covers	167
Comfort Fit Facemask	111
ContacEZ IPR System & Gauges	159
Convertible Cap Remover Instrument	67, 150
Copper Niti Archwire	79, 89
C.N.A. Nickel Free Archwire	78
Crimpable Stops/Ball Hooks	92-93
Curing Lights	129
CS System	16-17

D

Dappen Dishes	185
Dead Soft Wire	96
Debubblizer	175
De-Impactor Springs	96
Dimple Archwire	86
Diamond Discs	158
Direct Bond Lingual Cleat	97
Disc Guard Set	158
Disposa-Bowl	173
Disposable Impression Trays	174

Disposable Mouth Mirror	155	H	
Disposable Plaster Trap	180		Habit Control Device..... 99
Distalizing Spring	95-96		Hand Instruments..... 69, 151, 152-153
Dome Stripping Handle/Tips	160		Handpieces..... 189
DynaSticks Elastomeric Ties	104		Heat Sealer..... 192
E			Hemostats..... 153
Elastic Attachers.....	172		Hollywood Archwire..... 83
Elastic Sleeve/Thread/Tubing.....	109		Hygienic Waxes..... 194-195
Elastomeric Ties and Chain	104-105	I	
Electric Heat Knife.....	191		Impression Tray Cleaner..... 173
Electrodes	196		Impression Trays..... 174
Endurance SL Brackets	40-41		Impression Tray Adhesive..... 174
Eruption Chains.....	97		Imprinting Services..... 168-169
Essix Material.....	193		Intraoral Elastics..... 106-107
Etch Gel.....	114-115, 119, 125-126		Interproximal Stripping..... 158-161
Expansion Screws	186-187	J	
Extra-Oral Elastics	107		Jevan System..... 97
F		K	
Fabulustre Polish	180		Ketac Cement..... 125
Facebows.....	111		Keyhole Looped Archwire..... 90
Felt Cones	182		Koby Ties..... 98
Finishing Burs.....	121		Kromopan..... 175
Flat Retainer Wire.....	99, 116, 118, 119		Krystal Brackets..... 50-51
Floss.....	170		Krystal SL Brackets..... 48-49
Floss Threaders	170	L	
FlowTain.....	115		L'il Palates..... 197
Flux.....	196		Lab Wire..... 87, 184
Fog Free Photo Mirror System.....	137		Lang Aquapres..... 188
G			Ligature Wire..... 98
GC Fuji/Fuji Ortho	122-124		Light Cure Glasses..... 129
Gas Burner.....	181		Lightening Strips..... 160
Gemini Brackets	38-39		Lingual Buttons..... 97-98
Gemini Bondable Molar Brackets	68-69		Lip Bumper Tubing..... 109
Glacier.....	10, 159, 190		
Gold Archwire.....	85, 91		

Lip Protector	167	Organizers	88, 104-105, 107, 150, 166, 175
M		Ortho Care Kit	169
Mathieu Forcep	150	P	
Medica 28	197	Pedo Bands	57
Medit	12-13	Personalized Products	168-169
Metal Primer	120	Photographic Mirrors	135-137
MI Paste and MI Paste Plus	122	Plaster & Stone	181
MicroBrush	128	Plaster Knife	181
MicroEtcher/Accessories	189	Plaster Nipper	181
MicroMotor	188	Plastic Conditioner	120
Mini Molds	100-101	Plastic Spatulas	128
Mirrors, Photography	135-137	Platypus Flosser	170
Mixing Bowl/Spatulas	173	Plier Brite Ultrasonic Solution	145
Mixing Pads	127	Pliers	140-149
Model Base Formers	182	Polar Bear Instrument	150
Model Storage Boxes	180	Polishing Brushes	182
Molar Bands	54-57	Porcelain Conditioner	120
Molar Uprighting Springs	96	Pontic Wax	166
Mouthguards	176-177	Power Chain	104
Mouth Mirrors	155	Precision Aligner Buttons	14-15
MTX Brackets	36-37	Pre-Stopped Wire	74-75, 89
Multi-Force Archwire	80	Pre-Torqued Archwire	81
Multi-Just Facemask	110	Proform Mouthguard Material	176
Mushroom Looped Archwire	90	Prophy Pumice	118, 125
Muslin Buffs	182	Prophy Cup Holder/Instrument	126
N		Prophy Cups	126
Nickel Titanium Archwire	76-77, 86, 88	Proxi Brushes	170
Niti Springs	94	Q	
NOLA Dry Field System/Accessories	131	QCM Retainer/Labial Bow	184
Norris Archwire	74-75	R	
Norris Double Take Mirror	137	Raintree Essix Material	193
Norris System	4-9, 24-25	Release Modules	110
O		Reliance Products	114-116, 118-121
Opro Self-Fit Mouthguards	177	RENU Instrument Repair Service	154

Retainer Brite	165	Toothbrushes	171
Retainer Cases	164-165	Trays	192
Reverse Curve Archwire	86	Tray Covers	192
Right Stuff Kits	169	Twist Wire	87
Rotation Wedges	109		
S		U	
Safety Glasses	129, 199	Ultrasonic Solution	145
Safety Key	185	V	
Scalers	151	Vacuum Forming Machine	191
Scissors	153	Vertical Slot Add-On Hooks	93
Separator Plier	108	Vibrator	181
Separators	108	W	
Silver Solder	196	Water Bath	181
Spatulas	128, 173	Wax	166-167, 194-196
Sponge Pellets	118, 128	Weldable Lingual Attachments	57
Spoiled Ligature Wire	99	Weldable Bicuspid Brackets	58
Stainless Steel Archwire	82-83	Weldable Molar Brackets	66-67
Stainless Steel Coil Spring	94	Wonderfill	180
Stainless Steel Impression Trays	172	Wood Handled Spatula	173
Stainless Steel Ligatures	98	Z	
Stainless Steel Lab Lengths	87, 184	Zand Gauge	181
Sterilizers	198		
Sterilization Pouches	192		
Stop Locks & Wrench	92		
T			
TAC Tray Adhesive Spray	174		
Therapy Wafers	172		
Thermal Archwire	77		
Thermaknife	191		
Thickness Gauge Set	159		
Titanium Molybdenum Archwires	88		
Tongue Blocks	133		
Torches	185		
Tooth Dryer	124		

ORDERING OPTIONS:

Visit Us Online:
www.dynaflex.com

Contact Your Local Rep

Call Us Toll Free:
866-346-5665

Notes:

Notes:

Notes:

Notes:

Separate Cover File



Local: 314-426-4020 • Fax: 314-429-7575
8050 Hawk Ridge Trail
Lake St. Louis, MO 63367
info@dynaflex.com • www.dynaflex.com

Products: **866.346.5665**
Fax: **314.426.1967**

Laboratory: **800.489.4020**
Fax: **314.429.7575**